

Effect of Substrate Concentration to Anode Chamber Performance in Microbial Electrolysis Cell

Libertus Darus

Politeknik Negeri Pontianak, Kalimantan Barat, Indonesia

Abstract

Microbial electrolysis is a promising process for bio-hydrogen production which might be implemented in waste water treatment in a near future. Unfortunately substrate could be converted into methane by acetoclastic methanogens and will reduce the coulombic efficiency (CE). The research objective was to study the competition between electrogens and methanogens for substrate in a continuous Microbial Electrolysis Cell (MEC).

The competition was studied in relation to controlling acetate influent concentration (C_{in}) from 35 to 1 mM with a fixed anode potential -350 mV, by assessing activity of electrogens as current density (CD), activity of acetoclastic methanogens as methanogenic consumed acetate (C_{meth}), and CE and by measuring anolyte protein content to confirm a steady state condition. Controlling C_{in} from 35 to 1 mM resulted in tendency of both CD and C_{meth} to decrease and CE to increase. At decreasing C_{in} from 35 to 5 mM which left excess acetate concentration in anolyte, the CEs were between 36.4% and 75.3%. At further decreasing C_{in} to 1 mM the acetate concentration was limited (C_{ef} 0 mM), but the CE only reached 95.8%. Methanogenesis always occur and electrogens were not able to outcompete the acetoclastic methanogens even though the substrate concentration was limited.

Keywords : microbial electrolysis cell, bio-hydrogen, metanogenesis, substrate concentration

Introduction

Related to the increasing oil price, the increasing energy demand and climate change, alternative renewable green energy gains popularity (Renewable Power Options, 2009). These three issues have speeded up the renewable energy market growth. Hydrogen consumption for energy produces only water while hydrocarbon or carbon consumption releases CO_2 . This green house gasses associated aspect makes hydrogen a potential green energy carrier for the future (Johnston *et al.*, 2005).

In 1911 for the first time electric energy which was generated from microbial

disintegration of organic compounds was reported by Potter. An electromotive force occurred between electrodes immersed in yeast cultures. The report is considered as the birth of the so-called Microbial Fuel Cell (MFC) technology (Schroder, 2007). An MFC consists of two chambers: an anodic and a cathodic chamber which are separated by a membrane. In the anode chamber, electrogens (microorganisms belong to most phyla of bacteria) oxidize biodegradable organic compounds to electrons, protons and bicarbonate (Logan and Regan, 2006). With a small modification of the electron acceptor used in cathode chamber in MFC, hydrogen is generated by overcoming the endothermic barrier with a little additional energy in the form of electrical energy (Cheng and Logan, 2007). This process is called Microbial Electrolysis Cell (MEC) Technology (Logan *et al.*, 2008). In MEC, water is used as electron

^{*)}Corresponding author :

Libertus Darus

Gedung TPHP, Politeknik Negeri Pontianak, Jl.A.Yani 1 Pontianak 78124, Kalimantan Barat, Email:retok_acin2006@yahoo.com; Tel.:+62 813 8214 2996

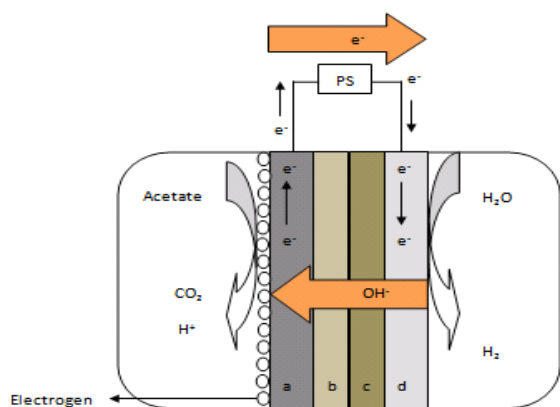
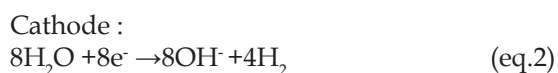
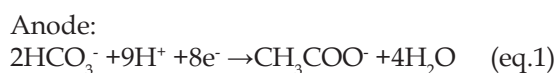

Figure.1. Working principle of MEC equipped with an AEM. (a)anode; (b)spacer; (c)AEM; (d)cathode

acceptor instead of oxygen and reduced to hydroxyl and hydrogen gas (see eq.2 and Figure1) (Rozendal *et al.*, 2007).

In MEC substrate can be converted to both current and methane. The ratio of actual electron recovered from substrate as current, to maximum possible electron if all substrate removal produced current is defined as coulombic efficiency (CE). CE is a parameter used to express performance of MEC beside current density (CD) which is defined as the current produced normalized to the anode surface area. Optimization of MEC will allow higher hydrogen production rates above $10\text{m}^3\text{H}_2/\text{m}^3$ reactor liquid volume/day at overall efficiencies exceeding 90% and at applied voltages 0.3–0.4V (Rozendal *et al.*, 2006). This optimization will make the technology attractive for hydrogen production in combining with waste water treatment (WWT).

In case acetate is used as substrate in MEC, reactions in both chambers follow:



According to IUPAC convention, standard electrode potentials are reported

as a reduction reaction. So the oxidation of acetate occurs in anode chamber is described as a reduction reaction (eq.1).

Torres *et al.* (2007) and Rozendal *et al.* (2008a) emphasized methanogenic competition as an important microbiological challenge to investigate in order to increase the performance of MEC. There are two types of methanogenesis: (i) acetoclastic that use acetate to produce methane and (ii) hydrogenotrophic that use CO_2 and H_2 to produce methane (see eq. 4 and 5).



The acetoclastic methanogens which involve in anodic reaction will decrease CE because they consume the available substrate (Rozendal *et al.*, 2008b). The hydrogenotrophic methanogens could use H_2 in anode chamber which diffuses from cathode chamber. Although CE is not affected by hydrogenotrophic methanogenic activity, the energy liberated in this reaction (eq.5) is lost (Rabaey *et al.*, 2006). Moreover the recovery of the produced hydrogen is decreased. Fortunately Rozendal *et al.* (2006) estimated that at saturated condition the hydrogen diffusion to the anode chamber was relatively constant, meaning after steady state condition is reached hydrogenotrophic methanogens give no more contribution to the increase of methane concentration. Methane produced in anodic chamber then can diffuse to cathodic chamber and impure hydrogen product.

Possible variables which may influence if acetate will be consumed by electrogens or methanogens is substrate concentration. Substrate concentration has the possibility to influence the activity of electrogens by influencing the availability of acetate into biofilm. The objective of this research was to study the competition between electrogens and methanogens for substrate in a continuous MEC in relation to controlling acetate influent concentration (C_{in}) from 35

to 1 mM with a fixed anode potential -350 mV, in order to search for conditions on which the electrogens have a better chance of outcompeting the methanogens.

Materials and Methods

Bioreactor setup

The experiments were performed in an electrochemical cell and the cell consisted of four Plexiglas plates of 22×32 cm² of which the two outer plates served as the heating jacket for temperature control (303 K). The two inner plates served as the electrode chambers and were separated from each other by an anion exchange membrane (AEM) (Fumasep FKE, FuMA-Tech GmbH, and St.Ingbert, Germany). The electrode chambers consisted of vertically orientated channels (width 1.5 cm; depth 1 cm) for liquid transport (volume 0.28 L), and a headspace for gas collection (volume 0.03 L).

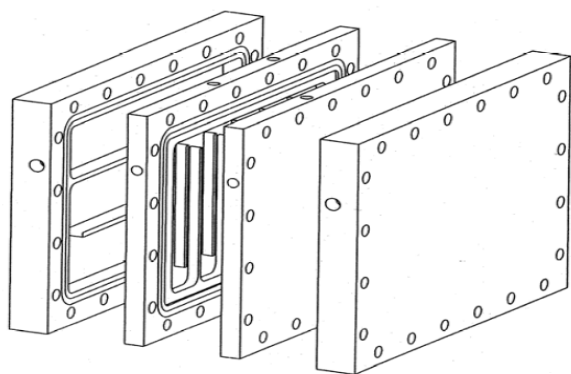

Figure 2. Design of the Plexiglas plates of the MEC.

Anode chambers contained graphite felt (effective surface area, 0.025 m²; thickness, 6.5 mm; National Electrical Carbon BV, Hoorn, The Netherlands) as the anode material. Three gold wires were pressed onto the graphite felt anode for current collection. Two spacer materials (Sefar B.V., PETEX 07-4000/64, Goor, The Netherlands, thickness 2x1.9 mm) were placed between the graphite felt anode and the AEM to create a convective flow through the anode. The cathode consisted of a platinum coated (50 g/m²) titanium mesh (surface areas 0.025

m², thickness 1 mm, specific surface area 1.7 m²/m² - Magneto Special Anodes BV, The Netherlands) and directly pressed against the AEM. A Haber-Luggin capillary that was connected to an Ag/AgCl reference electrode (QM710X, ProSense BV, Oosterhout, The Netherlands) was placed in both electrode chambers to control the anode potential and to measure the cathode potential. The anolyte and catholyte were continuously circulated using a pump (Masterflex® L/S®, Cole-Palmer Instruments Co., USA) via an external circulation loops (through 600 ml gas circulation bottle) with a speed of 340 ml/min. These circulation bottles were equipped with conductivity meters (ProSense QiS, Oosterhout, The Netherlands) and pH meters (Liquisys M CPM 253, Endress + Hauser). The electrochemical cells were each connected to a potentiostat (Wenking Potentiostat/Galvanostat KP5V3A, Bank IC, Germany) to control the anode potential in both cells. A data logger (Memo-graph, Endress + Hauser) continuously logged 8 variables for the cell: anode potential and cathode potential, and cell voltage, current, anode and cathode pH, anode and cathode conductivity. All experiments were performed at 303 K.

Medium

The anode chamber of cell was operated in continuous mode by supplying a microbial nutrient medium (5 mL/min). Prior to entering the anode chamber, the microbial nutrient medium was flushed with nitrogen from a nitrogen generator (purity >99.9%) to ensure the anaerobic environment. The standard microbial nutrient medium was with a carbon source and contained (in deionized water) the following: 0.74 g/L KCl, 0.58 g/L NaCl, 0.68 g/L KH₂PO₄, 0.87 g/L K₂HPO₄, 0.28 g/L NH₄Cl, 0.1 g/L MgSO₄ · 7H₂O, 0.1 g/L CaCl₂ · 2H₂O, and 0.1 mL/L of a trace element mixture (Zehnder *et al.*, 1980). The cathode chamber of cell was operated in batch mode by supplying a solution consisted of 0.68 g/L KH₂PO₄ and 0.87 g/L K₂HPO₄. The cell was started up by inoculating the anode with effluent of an

active MEC. Gasses left the system through a circulation bottle.

Methods

The substrate concentrations (added as sodium acetate) varied from 35 mM, 20 mM, 10 mM, 5 mM and 1 mM at a poised anode potential of 350 mV (against Ag/AgCl electrode). The controlled substrate concentration experiments were done until steady state conditions were achieved. Steady state was determined when a constant current density, constant substrate concentration and constant protein content in the anolyte was reached. A constant protein concentration in the anolyte indicates a constant total biomass concentration in the anolyte. The steady state condition was kept for at least two days. The substrate concentration in influent and effluent as well as the protein content in anolyte were measured in duplicate once a day. Subsequently the last two data for CD, CE and protein content when the steady state was reached in every experiment were averaged. On the last day of the steady state condition, the headspace of the anodic chamber was sampled and measured for its methane fraction, acetate in catholyte as well as bicarbonate in anolyte were sampled and measured for their concentrations.

Analytical procedures

The acetate concentration was determined using Metrohm 761 Compact IC (equipped with a conductivity detector) and the bicarbonate concentration was determined using a total carbon analyzer (Shimadzu TOC-VCPH). A diluter machine (Microlab[®] 500 series, Hamilton, Nevada, USA) was used to dilute solution. The gas volume was measured with a gas flow meter (Milligascounter, Ritter Apparatebau GmbH&Co.KG, Bochum, Germany) and the gas fraction was measured by a gas chromatograph (Shimadzu GC-2010, Shimadzu Benelux, 's-Hertogenbosch, The Netherlands). The protein contents were measured by firstly breaking the cell wall of bacteria in anolyte sample using an ultrasonic

bath (Sonorex digitec DT 512 H, BANDELIN electronic, Berlin, German), then prepared by Bio-Rad Protein Assay method to further be measured by a spectrophotometer (Shimadzu UV-1650PC, UV-Visible spectrophotometer, Japan).

Calculations CE and CD

Coulombic Efficiency (CE) is calculated by:

$$CE = \frac{I_{measured}}{I_{theoretical}} * 100\%$$

, with:

$$I_{theoretical} = nFQ(C_{in} - C_{out})$$

Where $I_{measured}$ and $I_{theoretical}$ are the measured current and the theoretical current produced from the total acetate consumed (A), n is the amount of electrons involved in reaction for 1 mole reactant (mol/mol), F is Faraday's constant (96485.3 C/mol), Q is loading rate of influent (l/sec), C_{in} and C_{out} are concentration of acetate in influent and effluent respectively (M).

Current Density (CD) is calculated by:

$$CD = \frac{I_{measured}}{A_{anode}}$$

Where A_{anode} is the projected anode surface area (m²)

Results and Discussion

In anode chamber of MEC, substrate can be converted to both current by electrogens and methane by acetoclastic methanogens. The competition for the substrate will occur between the two microorganisms. The acetoclastic methanogens which consume the available substrate then will decrease coulombic efficiency (CE). Acetate influent concentration control was investigated for its influence on the competition in order to search for conditions on which the electrogens

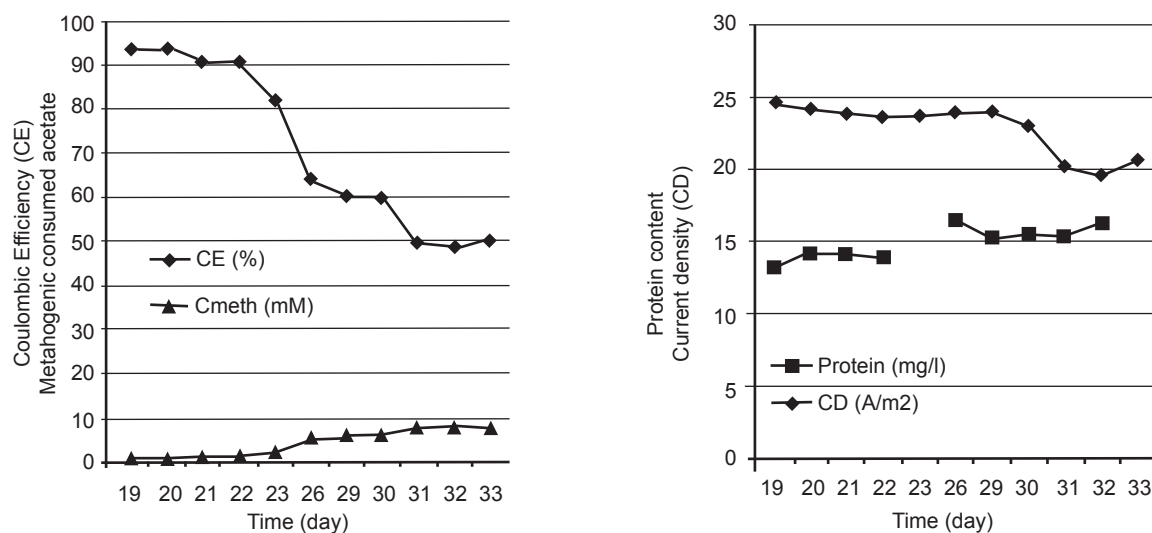

Figure 3. CE, C_{meth}, CD and protein content in anolyte as a function of time at E_{an} -350 mV and C_{in} 35 mM, at the end of acetate influent concentration control experiment.

have a better chance of outcompeting the acetoclastic methanogens.

A steady state condition at the end of experiment

A steady state condition occurs in anode chamber of MEC when the activities of microorganisms involve in anodic reactions reach stability. Coulombic efficiency (CE), the consumed acetate by acetoclastic methanogens (C_{meth}), current density (CD) and protein content in anolyte were measured and calculated to show a steady condition in anode chamber. A stable CE confirms both stable electrogenic and methanogenic activities, a stable C_{meth} confirms a stable activity of acetoclastic methanogens, a stable CD confirms a stable activity of electrogens and a stable protein content confirms stable total amount of microorganisms in the anode which confirms stable presence of total microorganisms.

Substrate concentration may influence the activity of electrogens and acetoclastic methanogens by influencing the availability of acetate into biofilm. In figure 4 it is shown that CE was between 36.4% and 75.3% during C_{in} 35 to 5 mM, indicates big parts of acetate removal to methane. At C_{in} 1 mM the CE reached 95.8% which indicated that even

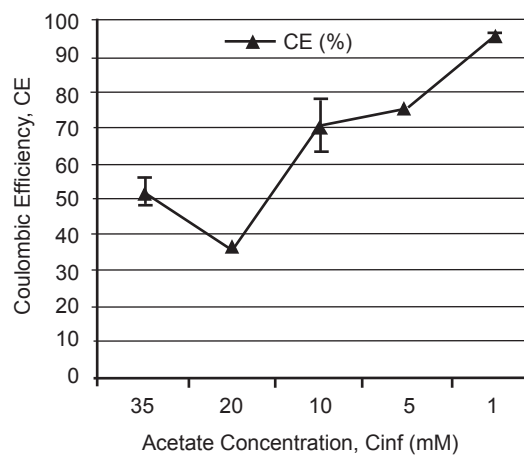

Figure 4. Coulombic Efficiency (CE) and protein content in anolyte as a function of acetate influent concentration and at fixed E_{an} of -350 mV.

though the acetate concentration was limited, electrogens were not able to outcompete the acetoclastic methanogens.

Electrogenic activity (CD) in relation to the acetate influent concentration control (C_{in})

Figure 5 shows that at C_{in} of 35 mM the CD, which represent electrogenic activity, reached the highest value of 21.1 A/m². Decreasing C_{in} resulted in a proportional decrease in CD, which reached the minimum value of 2.4 A/m² at C_{in} of 1 mM. This is because

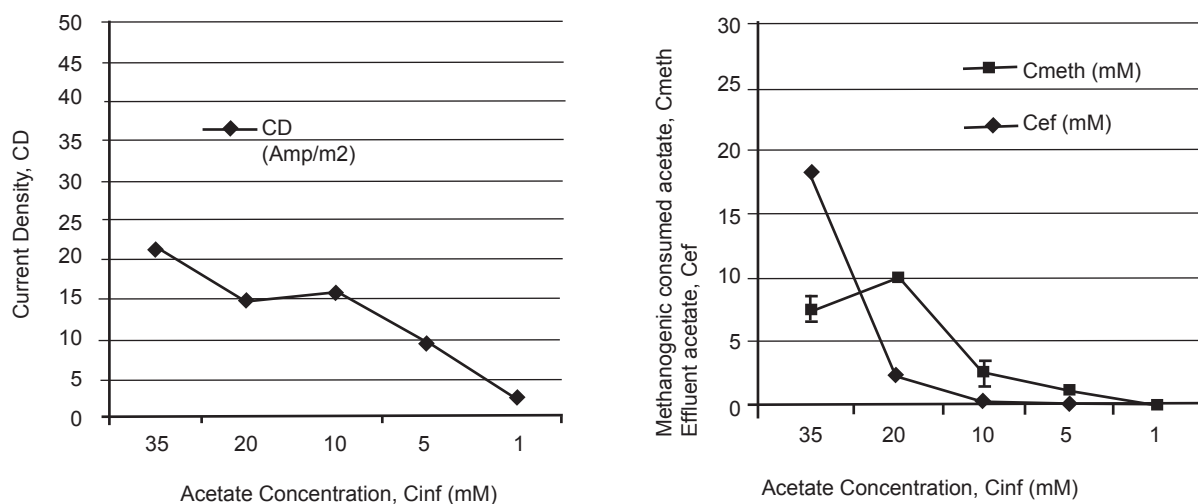

Figure.5. Current Density (CD), Methanogenic consumed acetate (C_{meth}), and Effluent Acetate Concentration (C_{ef}) as a function of acetate influent concentration and at fixed E_{an} of -350 mV.

a lower C_{in} provides less acetate available into biofilm which is then converted to electrons. Except, while C_{in} was decreased from 20 to 10 mM, CD increased from 14.8 to 15.7 A/m². From figure 5 it seems that the CD at 20 mM which is lower than that at 10 mM is caused by the high C_{meth} and the reason why this was occurred is not understood.

Methanogenic activity in relation to the acetate influent concentration control (C_{in})

At a decreasing C_{in} from 35 mM to 20 mM, the activities of acetoclastic methanogens (represented as C_{meth}) were increased from 7.6 to 10.1 mM (Figure 5). The reason for C_{meth} at 20 mM which is higher than that at 35 mM is not understood, but this is related to CD at 20 mM which is lower than that at 10 mM. The calculation of C_{meth} was related to the CD.

In figure 5 at an C_{in} 35 and 20 mM, effluent acetate concentrations (C_{ef}) were 18.4 mM and 2.4 mM respectively. The CEs were 52.0 % at C_{in} 35 mM and 36.4 % at C_{in} 20 mM, indicating there was a big part of acetate converted to methane in this excess acetate. At further decrease of C_{in} to 10, 5, and 1 mM, C_{meth} then decreased to 2.6, 1.2, 0.04 mM respectively (Figure 5). Attention to effluent acetate concentration (C_{ef}) may be able to explain the decreased activity of

acetoclastic methanogens. At C_{in} 10, 5 and 1 mM, C_{ef} were 0.2, 0.2 and 0.0 mM respectively. Since the systems are continuous, the acetate concentration in anolyte is the same as C_{ef} . It seems like at this low acetate concentration in the anolyte, the acetoclastic methanogens were not able to use it at all. The decreased C_{meth} is in line with the increased CE to 70.4, 75.3 and 95.8 % respectively for C_{in} 10, 5, and 1 mM (Figure 5). It is clear that electrogens started to win the competition during C_{in} 10, 5 and 1 mM. Although acetate is already limited, the CE only reached 95.8% at C_{in} 1 mM. Electroogens were not able to outcompete acetoclastic methanogens. Moreover supplying a very low acetate concentration (1 mM) to the system is not practical.

It is concluded that in this experiment methanogenesis always occur and electroogens were not able to outcompete the acetoclastic methanogens even though the substrate concentration was limited.

References

- Cheng, S., Logan, B.E., 2007. Sustainable and efficient biohydrogen production via electrohydrogenesis. *Proc. Natl. Acad. Sci. USA.*, **104**, 18871-18873
- Johnston, B., Mayo, M. C. & Khare, A. 2005 Hydrogen: the energy source for the

- 21st century. *Technovation*. **25**, 569–585. (doi:10.1016/j.technovation.2003.11.005)
- Logan, B.E., Regan, J.M., 2006. Microbial fuels cells: challenges and applications. *Environ. Sci. Technol.*, 5172- 5180
- Logan, B.E. Rozendal R.A, Hamelers H.V.M, Call, D, Cheng, S. Sleutels, T.H.J.A and Jeremiase A.W, 2008. Microbial electrolysis cells for high yield hydrogen gas production from organic matter. *Environ. Sci. Technol.*, **42** (23), 8630-8640
- Rabaey, K., Vandesompele, K, Maignien L, Boon N, Aelterman P, Clauwaert P, De Schampelaire L, Pham H.T, Vermuen J, Verhaege M, Lens P and Verstraete W , 2006. Microbial fuel cells for sulfide removal. *Environ. Sci. Technol.*, **40**, 5218–5224
- Renewable Power Options. (2009) *The Increasing popularity of renewable energy careers*. <http://www.renewablepoweroptions.com/news-articles/>
- Rozendal, R.A., Hamelers H.V.M, Molenkamp R.J, and Buisman C.J.N. 2007. Performance of single chamber biocatalyzed electrolysis with different types of ion exchange membranes. *Water. Res.*, **41**, 1984-1994
- Rozendal. R.A., H.V.M. Hamelers, G.J.W. Euverink, S.J. Metz, and C.J.N. Buisman, 2008a. Hydrogen production with a microbial biocathode. *Environ. Sci. Technol.*, **42**, 629–634
- Rozendal, R.A., H.V.M. Hamelers, Rabaey K, Keller J and Buisman C.J.N. 2008b. Towards practical implementation of bioelectrochemical wastewater treatment. *Tren. Biotechnol.*, **26** (8) doi:10.1016/j.tibtech.2008. 04.008
- Schroder, U., 2007. Anodic electron transfer mechanisms in microbial fuel cells and their energy efficiency. *Phys. Chem. Phys.*, **9**, 2619–2629
- Torres, C.L., Marcus A.K, and Rittmann B.E., 2007. Kinetics of consumption of fermentation products by anode-respiring bacteria. *Appl. Microbiol. Biotechnol.*, **77**, 689–697
- Zehnder, A.J.B., Huser B.A, Brock T.D and Wuhrmann K, 1980. Characterization of an acetate-decarboxylating, non-hydrogen-oxidizing methane bacterium. *Arch. Microbiol.* **124** (1), 1-11