

## Making Boundaries and Site Plans in Nambo Village, Lasalimu District, Buton Regency

Muh. Sayfullah. S<sup>1\*</sup>, Idwan<sup>1</sup>, Ahmad Efendi<sup>1</sup>, Agusman<sup>1</sup>, Sitti Febriyany Aldha<sup>1</sup>

<sup>1</sup>Civil Engineering Department, Universitas Muhammadiyah Buton, Indonesia

Correspondence: [muh.sayfullahs@gmail.com](mailto:muh.sayfullahs@gmail.com)

### ABSTRACT

*Buton Regency is a Level II region in the Indonesian province of Southeast Sulawesi. Nambo Village is comprised of three hamlets: Nambo, Lagonturu, and Tandaompure. It has an area of 25.5 kilometers. When it comes to carrying out operations, both government and community social, the people of Nambo community constantly promote mutual collaboration. The Village Government and Karangtaruna both have programs for planning and designing village boundaries and site plans, however relevant parties lack the skills or knowledge to participate in the planning and design process. The debate outcomes resulted in the design of the Nambo village border and site layout, as well as the materials to be utilized in the village boundary construction process. To enhance the look of the border, mountain stone foundations, brick walls, and natural stone are employed.*

**Keywords:** Boundary; Design; Lasalimu; Nambo Village; Site Plan

Copyright © 2022 The Author(s); This is an open-access article distributed under the terms of the Creative Commons Attribution ShareAlike 4.0 International (CC BY-SA 4.0)

### 1. Introduction

Buton Regency is a Level II region in the Indonesian province of Southeast Sulawesi. Buton Regency is located on Buton Island, which is the biggest island in the Sulawesi Archipelago outside of the main island, ranking as the world's 130th largest island. Wajo Market serves as the district capital. This district has an area of 2,488.71 km<sup>2</sup> (before the 6,463 km<sup>2</sup> extension) and had a population of 265,724 people in 2004. (before the expansion of 533,931 people) (BPS, 2019a). Buton Regency is well-known for its asphalt production. Lasalimu is a subdistrict in Buton Regency, Indonesia's Southeast Sulawesi.

Apart from Pasarwajo, Lasalimu is another location in Buton Regency that produces asphalt. Lasalimu is located on Buton Island and Buton Regency's shore. Apart from being the district's administrative hub, Lasalimu is also a tourist destination. Lasalimu also includes a number of commercial and shopping areas. Numerous maritime industry are also located here. This is why the city is known as Lasalimu. Nambo Village was formed by the partition of Suandala Village and is a fertile rural location. The people's livelihoods are primarily agriculture, including agricultural fields, and some are fisherman and others (Sarman, 2020).

Apart from that, Nambo Village is a mining location for asphalt (Buton Asphalt), a material that is now widely used across Indonesia. Residents of Nambo Village have witnessed

various well-known enterprises benefit the community through employment, despite the fact that they make up a small portion of the village's population (Muh. Sayfullah et al., 2021).

Nambo Village is comprised of three hamlets: Nambo, Lagonturu, and Tandaompure. It has an area of 25.5 kilometers. The people of Nambo always prioritize mutual cooperation and assistance among some of these hamlets when carrying out activities, both government and social, such as the construction of public facilities, because only through hard work and a high level of enthusiasm can the area's development be successful. The community of Nambo and Alhamdulillah, which is just a year established, can already compete with neighboring communities in Southeast Sulawesi Province's Lasalimu District, Buton Regency (Sarman, 2020).

## 2. Methodology

The actions taken to carry out this service activity are as follows:

1. The first stage is to perform a field survey by direct observation at the site of the proposed activity in order to collect data from field measurements.
2. Coordinate with relevant parties to ensure that the data gathered is used to develop the design in line with the desired needs.
3. Oversee the process of design planning.
4. Hold talks about the outcomes of the design planning process.

## 3. Result and Implementation

### 1. Establishing the Nambo Village Boundary

The companion gave numerous design ideas for the village border design concept based on the challenges encountered by the Village Government and the Nambo Village Karangtaruna. The debate outcomes resulted in the design of the Nambo village border and the materials that would be utilized to construct the village boundary. To enhance the look of the border, mountain stone foundations, brick walls, and natural stone are employed.

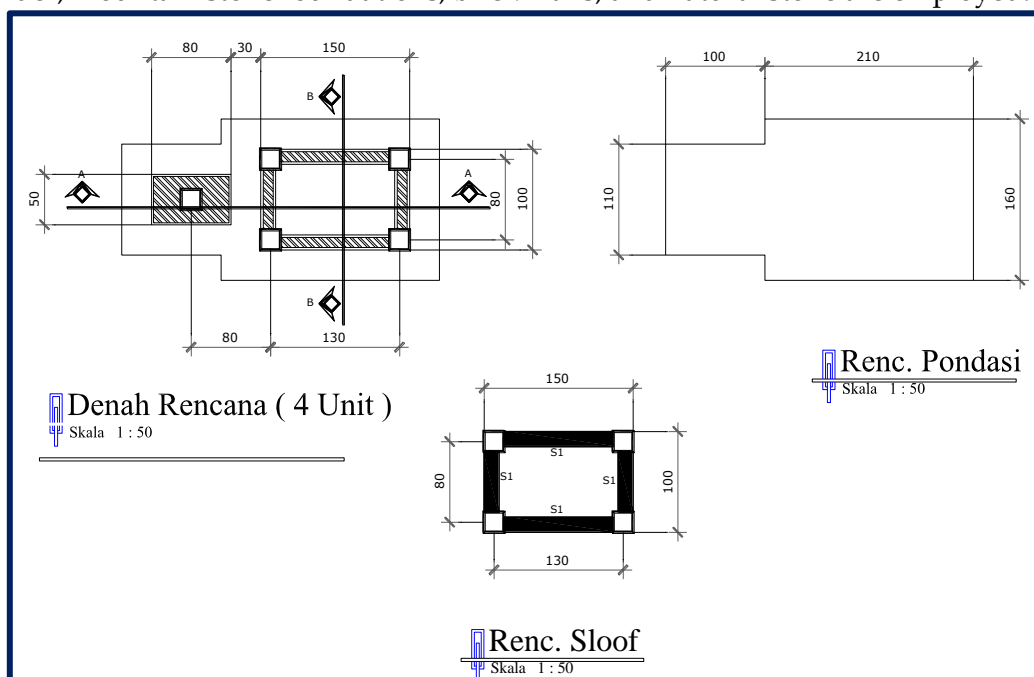

Figure 1. Nambo Village Boundary Plan Plan

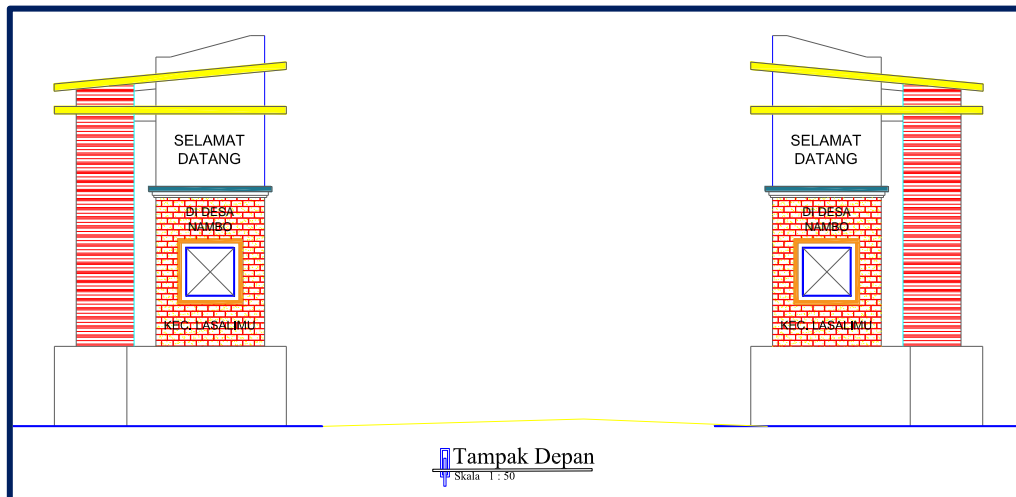

Figure 2. Front View of Nambo Village Boundary

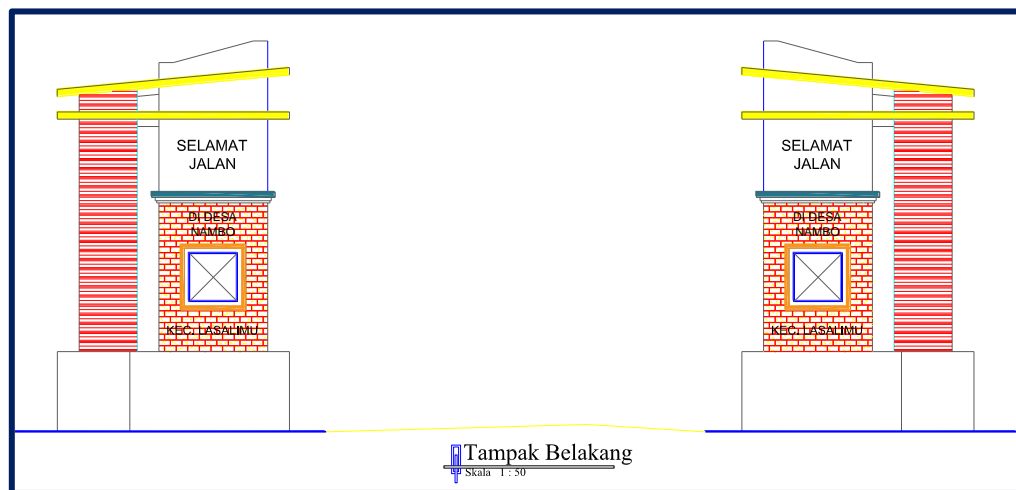

Figure 3. Rear View of Nambo Village Boundary

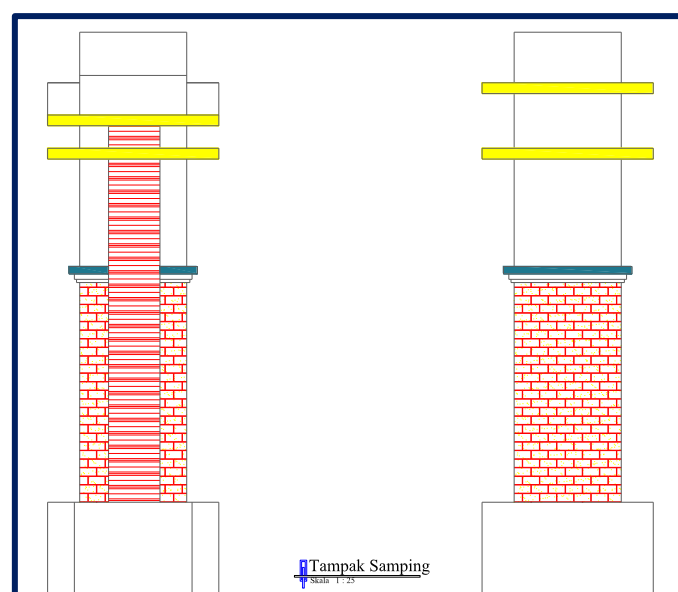

Figure 4. Side View of Nambo Village Boundary

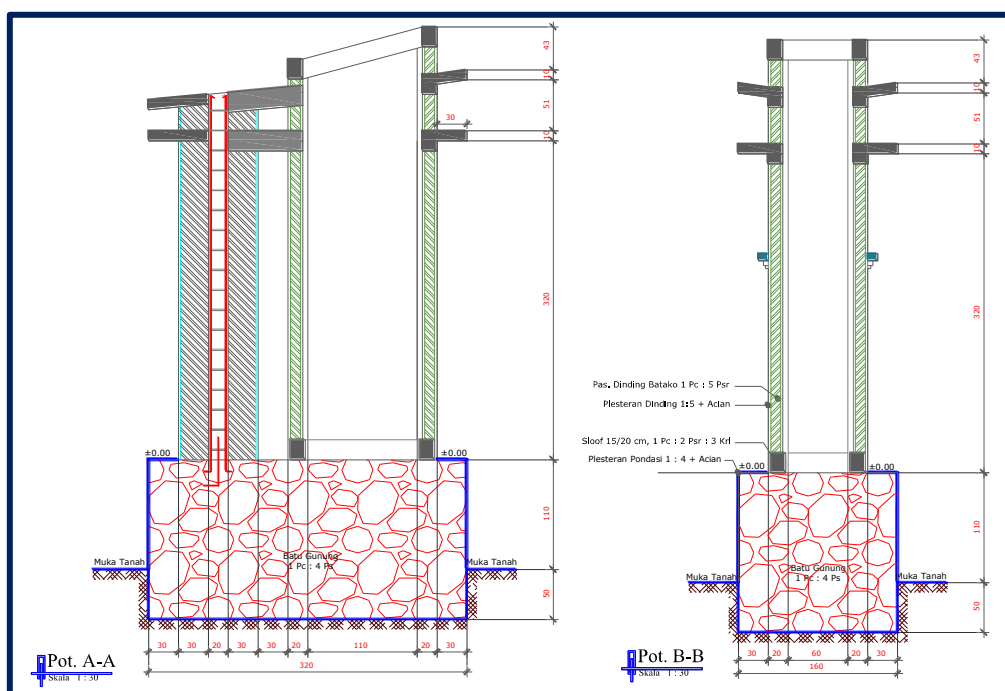

Figure 5. Nambo Village Cuts

2. Nambo Village Site Plan

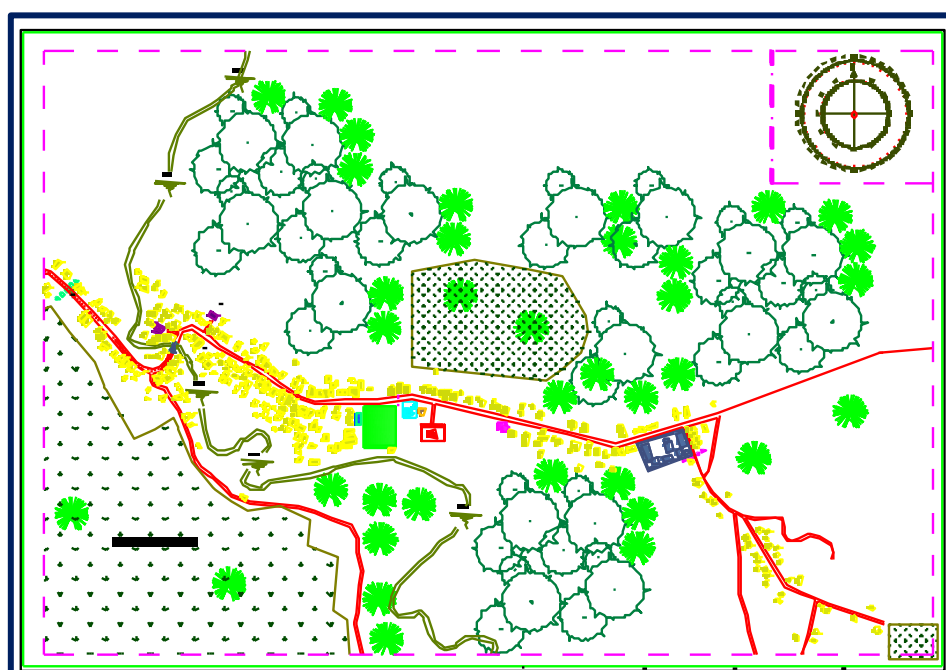

Figure 6. Site Plan

The results of field observations of all village areas, point taking, as well as several other data obtained from relevant village apparatus stakeholders ((BPS, 2019), (Desa Nambo, 2019) as well as downloaded satellite images were then processed using the AutoCAD 2007 application. The existing data was then overlaid for the georeferencing process. , digitizing

maps to finalizing the Site Plan (layout site plan). In this activity, the map is laid out with a scale of 1:1500 on a paper size of 1 x 1 m (scaled).

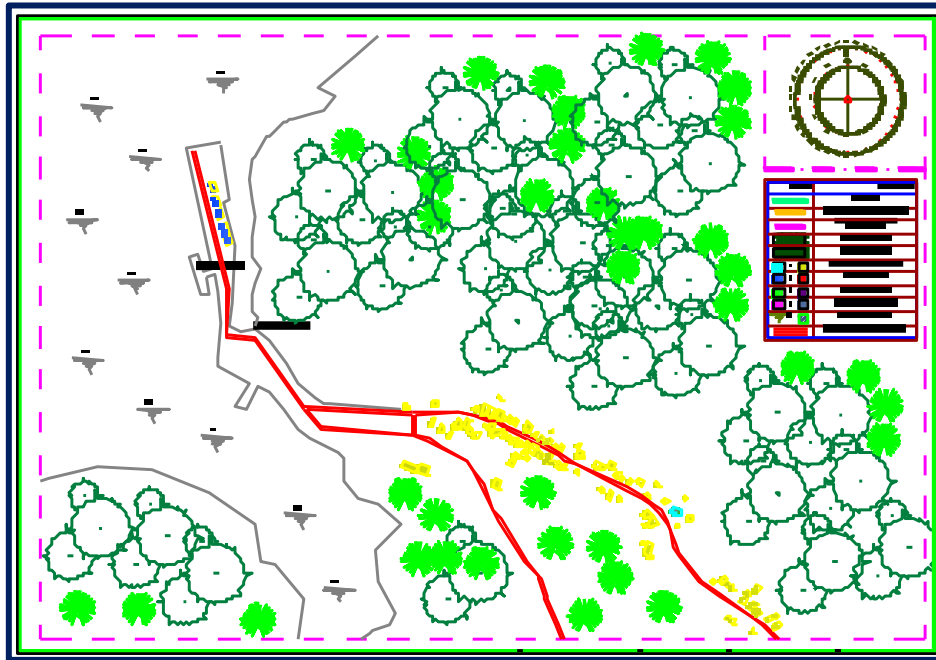

Figure 7. Site Plan

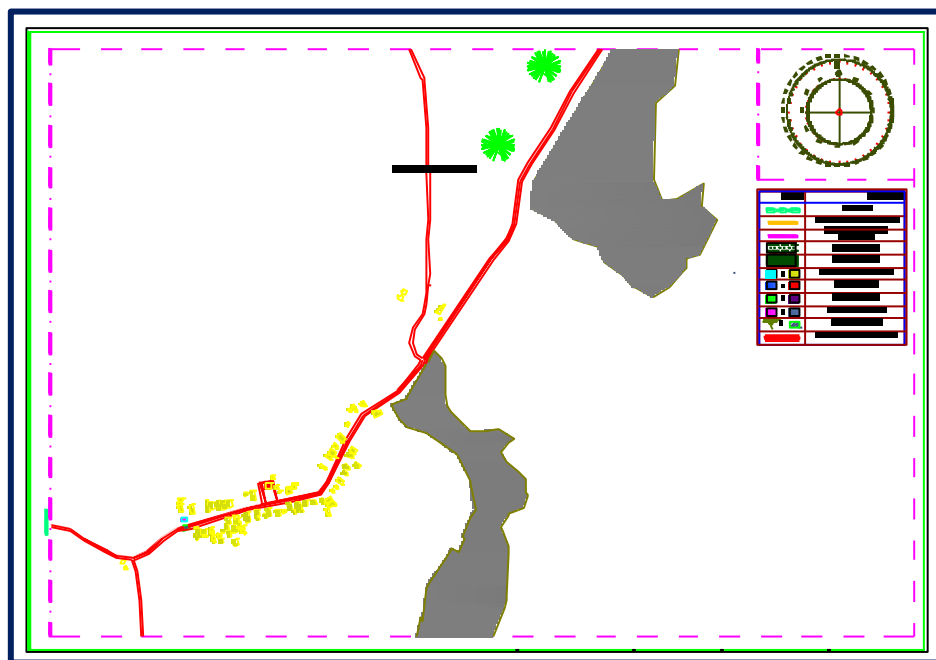

Figure 8. Site Plan

#### 4. Conclusion

Several outcomes were obtained from this service, including the design concept for the Nambo village border and the Site Plan, as well as the materials that would be utilized in the village boundary's implementation process. To enhance the look of the border, mountain stone foundations, brick walls, and natural stone are employed. The Village Government hopes to

collaborate with the Faculty of Engineering's Civil Engineering Study Program at the University of Muhammadiyah Buton to assist with design planning in the building industry.

### References

BPS. (2019a). *Kabupaten Buton dalam Angka 2019*.

BPS. (2019b). *Kecamatan Lasalimu dalam Angka 2019*.

Desa Nambo. (2019). *Kecamatan Lasalimu*.

Sayfullah, M., Musrifin, & Zain, W. O. R. (2021). Perencanaan Desain Mushollah Al-Fatah SDN 20 Lakudo Desa Madongka Kecamatan Lakudo Kabupaten Buton Tengah. *Jurnal Pengabdian Kepada Masyarakat Membangun Negeri, Vol. 5 No.*

Sarman. (2020). *Kepala Desa Nambo. Kecamatan Lasalimu. Kabupaten Buton. Diwawancarai Oleh Penulis, Muh. Sayfullah. S.*