

Web-Based Information System Of Building Materials At Berkah Mandiri Pekanbaru Shop

Purjumatin¹, Dina Mardiaty²

^{1,2}Program Studi Sistem Dan Teknologi Informasi, Institut Teknologi Bisnis Riau

Article Info

Article history:

Received 29-10-2022

Revised 26-11-2022

Accepted 12-12-2022

Keywords :

Material, PHP, MySQL

ABSTRACT

Information technology is currently one of the factors that support the growth and development of a dependable company in the era of globalization, which is characterized by a level of development that is becoming increasingly advanced and modern. Toko Berkah Mandiri Pekanbaru is just one example of a building materials company that continues to process its data manually. A reliable and speedy system is needed to meet the ever-increasing demand for information. A system is good if it makes all processes easier, including computerization, which is one of them. Using MySQL as the database and the PHP programming language, this application was developed. This system or application is very helpful, especially when it comes to processing important data in a way that makes data more accurate, efficient, quick, and can save time and money.

This is an open access article under the [CC BY-SA](#) license.



Corresponding Author:

Purjumatin

Program Studi Sistem Dan Teknologi Informasi, Institut Teknologi Bisnis Riau

Email: purjumatin89@gmail.com

1. INTRODUCTION

The need for information technology today is actually one of the factors that supports the growth and development of a reliable company in the era of globalization with an increasingly advanced and modern level of development. causing chaos in technical and strategic planning, operational control, and decision making. Because of the advantages that this technology offers compared to the manual method, namely data completion and time savings, compared to the manual method. A reliable and fast system is needed to meet the ever-increasing need for information. A system is said to be good if it simplifies all processes, including computerization, which is one of them.

It can be said that the use of computers as a tool for processing data is currently the best. Because it can speed up work and save time and effort in processing data. Manually operated cash sales systems can experience a number of problems, including the tendency to become saturated due to the large amount of data required. processed, the complexity of the process, and the short time required to process the data. processing and various data

As a result, calculation errors are more likely to occur, so a computerized sales system must be supported. Mandiri Berkah Building Shop, a business that sells building materials, also feels this way. So with this the author raises this topic in the title "Information System for Building Materials at the Web-Based Berkah Mandiri Pekanbaru Store"

The following are journals related to building material information systems found by the author at an independent blessing shop in Pekanbaru based on library results: Nursiah (2012), inventory program on the design of PT.Simut Sakti Jakarta. Programming in Microsoft Visual Basic 6.0 is used in this journal's reference. The author is determined, based on this journal reference, to produce a system that is better, more complete, and has more value than the relevant journal references

According to Tata Sutabri (2012), in the book "Information system analyst", in simple terms the system can be interpreted as a collection or file of elements, components, or variables that are organized, interact with each other, depend on each other and are integrated. The elements that represent a system in general are input, processing, and output. Examples of systems, inventory systems, banking systems, inventory systems, solar systems and many other systems. What is discussed here is the inventory system regarding building materials according to the title of my thesis. Inventory includes all goods owned by the company at a certain time, with the aim of selling or assumed for the future, all tangible goods can be called inventory, depending on the nature and type of the company's business.

Sistem inventory adalah suatu sistem software yang akan membantu proses inventarisasi dengan menerapkan tertib admin istrasi inventory yang ketat pencatatan dari barang masuk, penyimpanan, sampai dengan barang keluar. Sistem inventory ini dilengkapi dengan sistem pelaporan yang sistematis dan akurat. Adapun menurut Divisi penelitian dan pengembangan MADCOMS, inventory merupakan proses mengelola pengadaan atau persediaan barang di gudang [madcoms : 2011].

According to the Computer Forum (2010), in the book "Delphi 2010 Programming", a database is a collection of tabular data that is used to store information. The use of databases can be found in almost all types of applications today. Starting from multimedia applications, web browsers, to applications that really require a database specifically, such as staffing and sales applications. The number of database platforms that exist today has provided many choices for application developers.

According to Abdul Kadir (2009), in the book "Creating Report Applications Using PHP", PHP (Personal Home Page) is a scripting programming language which is very popular in making web applications. PHP is classified as open source, which implicitly means that we can use it without having to buy it.

According to Madcoms Madiun (2011), in the book "Adobe Dreamweaver CS6 with PHP & MySQL", Dreamweaver Creative Suite 6 or commonly abbreviated as CS6 is the leading software for building and editing the web by providing visual capabilities and code level, which can be used to create web-based standards and designs for desktop, mobile, smartphone, tablet, and other devices.

According to Edy Winarno ST, M.Eng (2013), in the book "PHP Programming Magic Book", HTML stands for Hypertext Markup Language, meaning that this language is a markup language for styling web page content. Or in other words, language to govern how web content is displayed and formatted.

According to Madcoms Madiun (2011), in the book "Adobe Dreamweaver CS6 with PHP & MySQL", CSS (Cascading Style Sheet) is a collection of codes for formatting, which controls the appearance of content in a web page. The application of CSS styles to the format of a page is placed separately from the appearance of the page. The content of your HTML code page is located in the HTML file, while the CSS code can be code that is in another file or in one part of the document and is usually placed in the head or tags.

According to Wahana Computer (2012), in the book "Easy to Make Online News Portals with PHP and MySQL", a browser is an application program that creates HTML code and displays website pages. This application is most often used for browsing in cyberspace.

Performing an analysis of the current system is intended as a basis for designing or repairing the old system. From this analysis it can be seen the weaknesses or deficiencies of the old system and can be designed or repaired into a better system.

Efforts to improve store performance are an effort to continue to provide the best service for consumers. The Material Information System at the Berkah Mandiri Pekanbaru Shop includes data collection activities for material shortages, preparation of order reports and material entry data needed by the admin. It is hoped that with this application, service to the availability of material stock can be even better.

2. METHOD

Performing an analysis of the current system is intended as a basis for designing or repairing the old system. From this analysis it can be seen the weaknesses or deficiencies of the old system and can be designed or repaired into a better system.

Efforts to improve store performance are an effort to continue to provide the best service for consumers. The Material Information System at the Berkah Mandiri Pekanbaru Shop includes data collection activities for material shortages, preparation of order reports and material entry data needed by the admin. It is hoped that with this application, service to the availability of material stock can be even better.

Based on the results of research at an independent blessing shop, checking for deficiencies and ordering materials still use the manual method, namely by checking directly to the warehouse and checking the store's material stock book, this takes quite a long time.

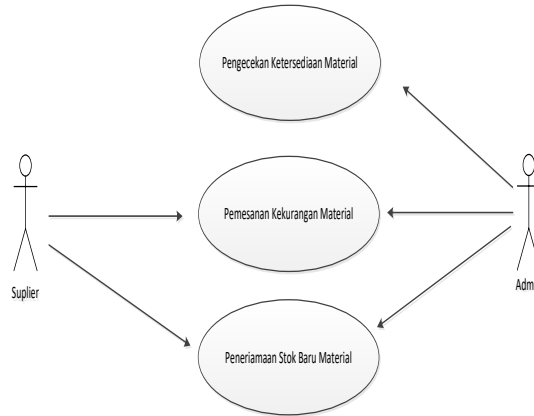

Figure 3.1 Use Case of the Current System

3. RESULTS AND DISCUSSION

System planning

The system that will be built will simplify the system that is currently running. With this new system, the service to material availability will be more efficient. Here will be explained the form of development and design of the Material Information System at the Berkah Mandiri Pekanbaru Shop that will be made.

1. Storing Material Data and Supplier Data.

The first step in using this application is that the admin can enter Supplier data as a supplier of materials needed by the store. And enter data on the availability of available materials, starting from the type of material to the amount of material available in certain units. This is useful for facilitating the ordering of materials in the future.

2. Checking Material Availability

The second step is the admin can check the availability of materials.

3. Conduct Material Order Transactions

The third step is that the admin can order less material stock and make a material ordering report.

4. Making Reports

The final step is that the admin can make the necessary reports and will later become proof of transactions or as archives by the store

Context diagram (Context Diagram) is a global design tool that shows the system in general and the parts of the sub-systems involved in the system as a whole, the linkages and interactions between the sub-systems. In the context diagram of the Material Information System at the Pekanbaru Berkah Mandiri Store, it consists of only one entity, namely admin.

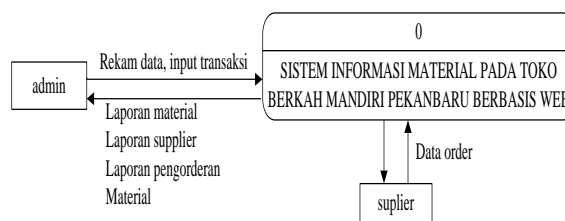

Figure 4.1 Context Diagram

4.1.2 Hierarchy Chart

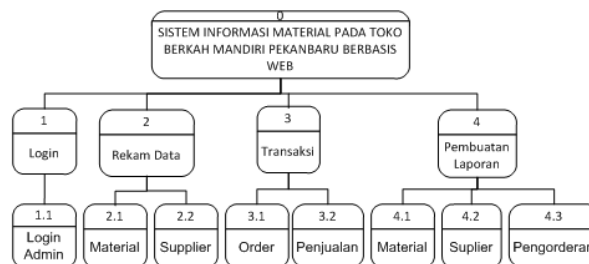

Figure 4.2 Hierarchy Chart

V.Model Design
Figure DFD Level 0

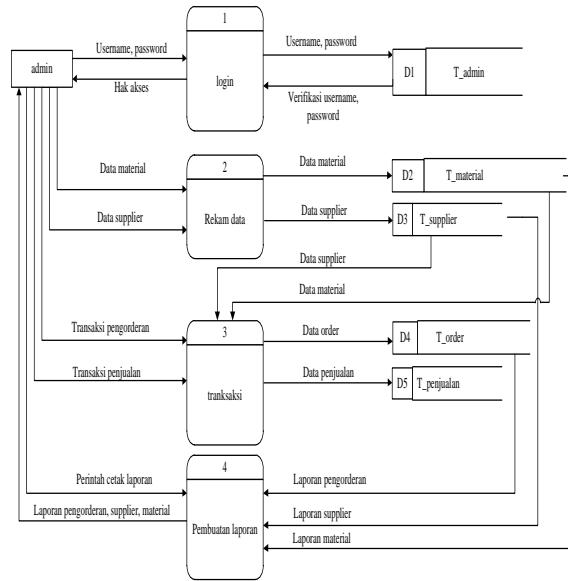

Figure DFD Level 0

In DFD level 0 there are four main activities, namely login, data recording, transactions and report generation. The user or users here are only admin. Here there are 4 tables, namely the admin table, materials, suppliers, orders and sales.

DFD Level 1 Process 1

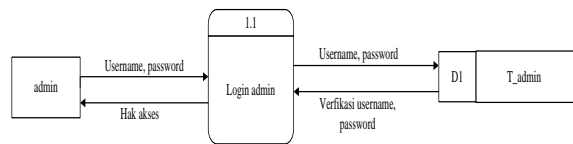

Figure 5.2 DFD Level 1 Process 1

In DFD level 1 process 1 there is only one activity, namely admin login. The user or users here are only admin. Here there is 1 table, namely the admin table.

DFD Level 1 Process 2

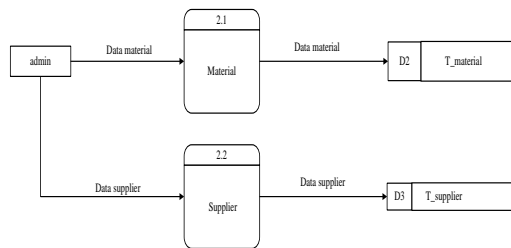

Figure DFD Level 1 Process 2

In DFD level 1 process 2 there are two main activities, namely material data and supplier data. The user or users here are only admin. Here there are 2 tables, namely the material and supplier tables.

5.4 DFD Level 1 Process 3

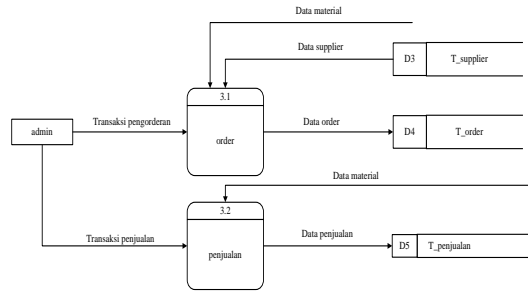

Figure DFD Level 1 Process 3

In DFD level 1 process 3 there are two main activities, namely orders and sales. The user or users here are only admins. Here there are 3 tables, namely the table of suppliers, orders and sales.

DFD Level 1 Process 4

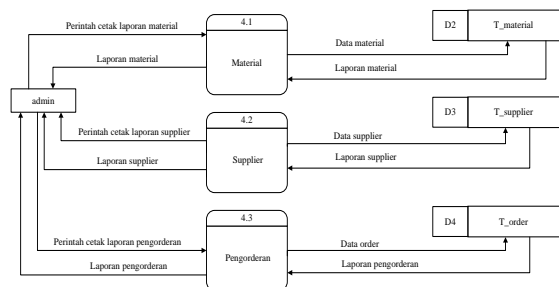

Figure DFD Level 1 Process 4

In DFD level 1 process 4 there are three main activities, namely material reports, supplier reports and order reports. The user or users here are only admin. Here there are 3 tables, namely the material table, suppliers and orders.

ERD (Entity Relationship Diagram)

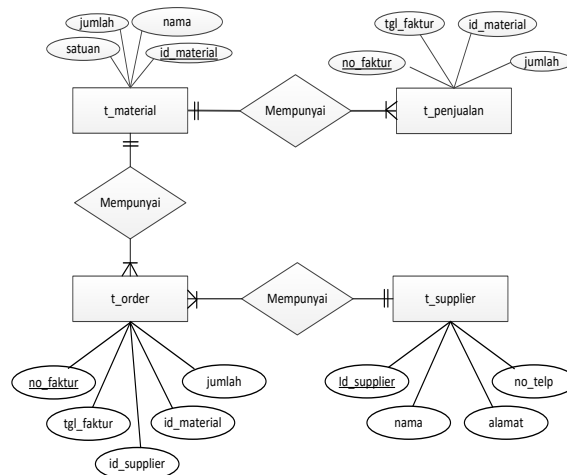

Figure Entity Relationship Diagram

The relationship between the t_material entity and the t_sales entity is one to many where one id_material in t_material can be sold by more than one invoice_number in the t_sales entity. And one id_material in t_material can be ordered by more than one invoice number on the t_order entity with one id_supplier on the t_supplier entity.

Implementation

System implementation is the stage where the system is ready to operate. This final stage aims to examine a series of systems, both Hardware and Software as a means of processing data and recording data. The several stages in implementing the program are as follows:

Hardware (Hardware)

Hardware specifications on the Laptop/PC used in this study are:

1. Laptop/PC Intel Core i5.
2. 2.4GB of RAM.
3. Modem as internet connection.
4. 1 TB hard drive.
5. Printer as a medium for printing
6. report.
7. Monitor, Mouse and Keyboard.

Software (Software)

The software used in making the Material Information System at the Berkah Mandiri Pekanbaru Shop, includes:

1. Operating system : windows 11.
2. Programming language: PHP and dreamweaper CS6.
3. DBMS (database management system): MySQL.
4. Notepad++
5. Chrome
- 6.2 Display List of Implemented Programs.



Figure 6.1 Login Display



Figure 6.2 Main Menu Display



Figure 6.3 Display of the Material Menu



Figure 6.4 Adding New Material Data Menu

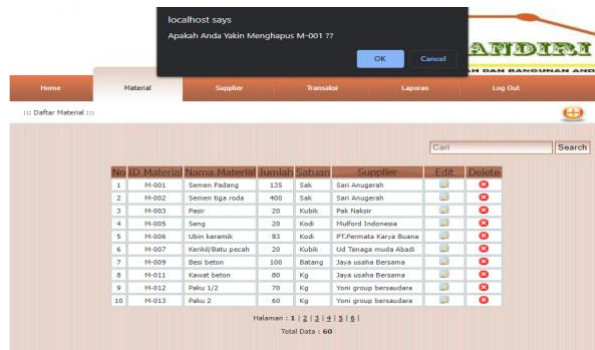

Figure 6.5 Delete Material Data



Figure 6.6 Editing or Changing Material Data



Figure 6.7 Supplier Menu

BERKAH MANDIRI
SOLUSI BELANJA KEBUTUHAN RUMAH DAN BANGUNAN ANDA

Home Material Supplier Transaksi Laporan Log Out

Form Tambah Supplier

Id Supplier : S-019
Name Supplier : purjumatn
Alamat : Sungai Pagar
No Telepon : 085235354555

SIMPAN BATAL

Figure 6.8 Adding Supplier Data Menu

localhost says
Apakah Anda Yakin Menghapus S-002 ??
OK Cancel

BERKAH MANDIRI
SOLUSI BELANJA KEBUTUHAN RUMAH DAN BANGUNAN ANDA

Home Material Supplier Transaksi Laporan Log Out

Daftar Supplier

No	ID Supplier	Nama Supplier	Alamat	No. Telp	Edit	Delete
1	S-001	Sari Anugerah	Hangtuh	085214922381		
2	S-002	Sinar Matahari	Panam	082383711331		
3	S-003	Yoni group bersaudara	Pandan	07618412432		
4	S-004	Raja Bangun	Arengka	08718417533		
5	S-005	Surya Pertama	Arengka	08717077676		
6	S-006	Raja Pipa	Arengka	08126301090		
7	S-007	PT.Permata Karya Buana	Garuda Sakti	07618416522		
8	S-008	PT. Bumi Andalas	Arengka	0761555178		
9	S-009	Pak-Nakos	Teratak-buluh	082388140498		
10	S-011	Ud Tenaga muda Abadi	Paus	082386872101		

Halaman : 1 | 2
Total Data : 17

Figure 6.9 View of Deleting Supplier Data

BERKAH MANDIRI
SOLUSI BELANJA KEBUTUHAN RUMAH DAN BANGUNAN ANDA

Home Material Supplier Transaksi Laporan Log Out

Ubah Supplier

Id Hubalk : S-001
Nama Supplier : Sari Anugerah
Alamat : Hangtuh
No Telepon : 085214922381

UBAH BATAL

Figure 6.10 Updating or Changing Supplier Data

BERKAH MANDIRI
SOLUSI BELANJA KEBUTUHAN RUMAH DAN BANGUNAN ANDA

Home Material Supplier Transaksi Laporan Log Out

Order Pengujian

Form Tambah Order

No Faktur : FO/011
Tanggal Faktur : 2022/10/30
Id Supplier : Id Material :
Nama Supplier : Nama Material :
Sisa Stok :
Tambah Stok
PROSES BATAL

Figure 6.11 Order Transaction Menu



Figure 6.12 Selecting a Supplier on the Transaction Order Menu

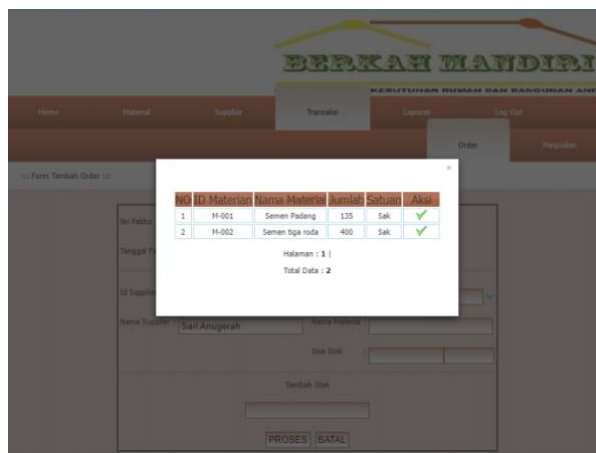

Figure 6.13 Selecting Materials on the Order Transaction Menu

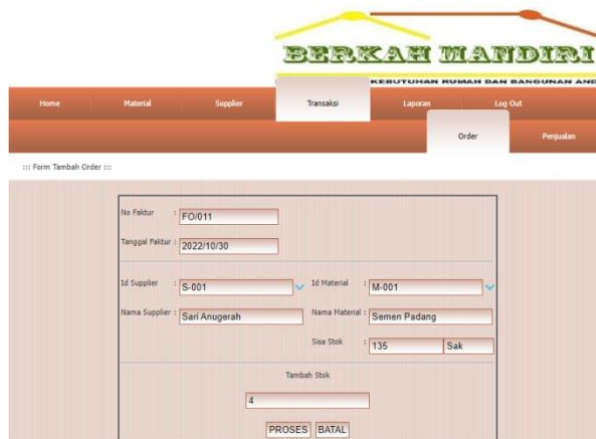

Figure 6.14 Order Transaction Menu When It Can Be Processed

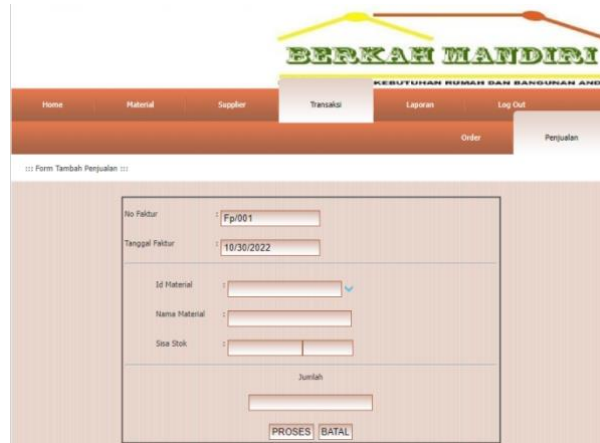

Figure 6.15 Sales Transaction Menu



Figure 6.16 Selecting Materials on the Sales Transaction Menu

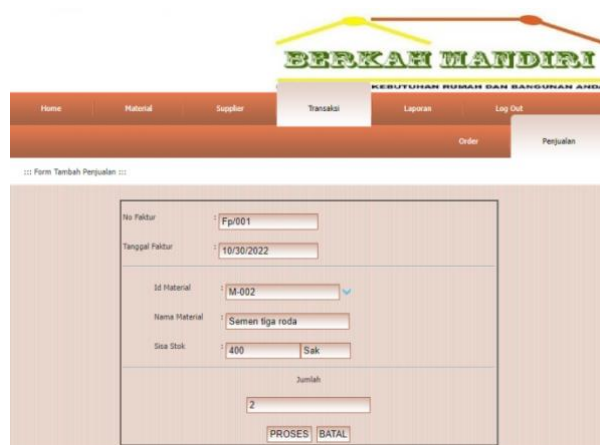

Figure 6.17 Sales Transaction Menu When It Can Be Processed

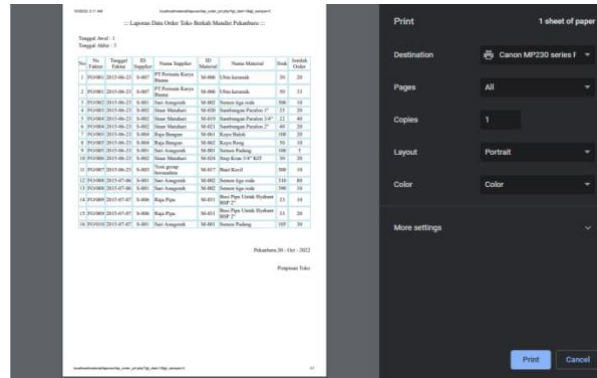

Figure 6.23 Order Data Report Print Menu

4. CONCLUSION

Based on the results of analysis testing, the building information system at the Pekanbaru independent blessing shop is web/localhost based. It can be concluded as follows:

1. The program is designed to help the performance of the independent blessing company/store. With the implementation of this program, it can overcome various obstacles in the independent blessing shop, especially the problem of building materials.
2. The material data processing system is only within the scope of the Mandiri Blessing Shop.
3. In this information system, the resulting output is in the form of material data reports, supplier data reports, and material coding data reports.
4. The material data processing system in this independent blessing shop is controlled by one admin.
5. This system provides fast, precise, effective, and efficient information.

ACKNOWLEDGEMENTS

Thank you to friends who have provided assistance in this research until it was published

REFERENCES

[1]. Sutabri. Tata., 2012, Analisis Sistem Informasi, Andi Offset, Jakarta
 [2]. Madcoms., 2011, Adobe Dreamweaver CS6 dengan PHP & MySQL, Andi Offset, Yogyakarta
 [3]. Edy, Zaki., 2013, Buku Sakti Pemrograman PHP, Elex MEDIA KOMPOTINDO, Semarang
 [4]. Madcoms., 2011, Adobe Dreamweaver CS6 dengan PHP & MySQL, Andi Offset, Yogyakarta
 [5]. Wahana Komputer., 2010, Delphi 2010 Programming, Andi Offset, Yogyakarta
 [6]. Kadir, Abdul., 2009, Membuat Aplikasi laporan menggunakan PHP, Andi Offset. Yogyakarta