

Designing a Honey Quality Tool Based on Gas Sensor and Color Sensor

Al Bima¹, Sirojul Hadi^{2*}, M. Najmul Fadli³, Nurul Hidayah⁴, Lalu Danu Prima Arzani⁵

^{1,2,3} Information Technology, Bumigora University, Ismail Marzuki street No.22, Mataram, Indonesia

^{4,5} Food Technology, Bumigora University, Ismail Marzuki street No.22, Mataram, Indonesia

*Corresponding author: sirojuhadi@universitاسbumigora.ac.id

(Received Sep 24 2022 ; Revised Sep 29, 2022 ; Accepted Sep 29, 2022)

Abstract—Honey has many benefits. Thus, honey counterfeiting often occurs with the ever-increasing demand. However, many do not know how to distinguish between real and fake honey, even honey breeders and hunters find it difficult to tell the difference. The honey used to test the quality of honey is honey produced by Apis dorsata bees or wild bees, the nectar consumed by these bees is the kesambi tree, the kesambi tree that grows a lot on the slopes of Mount Tabora, Bima district. Honey contains a lot of antioxidants such as vitamin C, pinocembrin, chrysin, pinobaksin, catalase, and many other ingredients that are very beneficial for the health of the body. Testing the authenticity of honey using two sensors, namely a gas sensor and a color sensor, the tool has been connected to a database and web application to display test data. The web application can be accessed from any location as long as it is connected to the internet network. The results of the research are the ideal distance for measurements is carried out as far as 2 cm. The success rate in testing pure honey with a mixture of honey has different values, such as the value of pure honey has a gas sensor voltage of 3.3 volts while the value of mixed honey with 50% pure honey and 50% sugar, the value of the gas sensor voltage is 2.54 volts. Mixed honey has a voltage below 3 volts. According of the color sensor test, namely the sensor output have different values, the RGB value for pure honey is red 206, green 246, and blue 182 while the RGB value for mixed honey is for 20% pure honey and 80% sugar mixture produces an RGB value of Red 156, Green 210, Blue 171. The color sensor can distinguish between real honey and mixed honey for trigona honey.

Keywords: Honey quality, TGS2602, TCS3200, Website

I. INTRODUCTION

Honey bee cultivation is popular cultivation in various countries, one of which is Indonesia. Indonesia has a fertile nature that makes it possible to cultivate various types of plants that can be used as a source of food for bees. According to data from the Central Statistics Agency from 34 provinces in Indonesia, only 5 provinces produce the most honey, namely West Nusa Tenggara, West Java, East Nusa Tenggara, Southeast Sulawesi, and West Sumatra. Honey in Indonesia is needed for direct consumption and used as a raw material for the cosmetic and pharmaceutical industries. Consumption of honey reaches between 10,000 to 15,000 tons / year. The authenticity of honey production is an important indication of the feasibility of consuming honey or cosmetic and pharmaceutical ingredients[1].

Honey is made by bees by processing nectar from flowering plants using enzymes found in their saliva. The enzyme is naturally contained in bee saliva which is then dissolved into nectar (plant juice) during the honey production period. Pure honey is very high in sugar. In addition, the water content in honey is very little which makes it very thick in texture. This viscosity makes sugar unable to ferment and oxygen is not easily dissolved into it. That way, the microbes that cause spoiled food cannot grow let alone reproduce. Honey also has an average pH level of 3.9 which indicates that this sweet liquid is acidic. Certain food-contaminating bacteria, such as C. diphtheriae, E Coli, Streptococcus, and Salmonella, cannot grow in an acidic environment. This acidic nature makes honey last for a very long time. Then, pure honey has a special enzyme called glucose oxidase which works to suppress the growth of bacteria[2].

Honey is not only used as a food ingredient, but honey also has many health benefits[3]–[7]. Thus, honey counterfeiting often occurs with an ever-increasing demand. However, many do not know how to distinguish between real and fake honey, even honey breeders and hunters find it difficult to tell the difference. Distinguishing real honey from fake honey is complicated because of the many types of honey circulating in Indonesia. Some are dark and bright in color, some have a liquid and thick consistency, a sharp and subtle aroma, and a sweet, sour, or bitter taste. There are no specific standards, for example, liquid honey means fake honey or honey that has a bitter taste, it is definitely real honey. However, recognizing fake honey is not as easy as imagined. Because to distinguish between real and fake honey, a technological approach is needed to accurately detect the authenticity of honey.

According to the Indonesian National Standard in 2004, the good water content in honey is 22%. Moisture content in honey can be affected by environmental humidity. The characteristic of honey is that it is hygroscopic, which means that it easily absorbs water. If the humidity is 51%, honey water content is 16.1%. If humidity is 81%, the honey moisture content is 33.4% [8].

Sensor-based technology can make it easier to distinguish between real honey and mixed honey. Sensors that can be used are color sensors and gas sensors. Testing the quality of honey using these sensors can be done on certain honey such as Trigona honey which is typical honey of West Nusa Tenggara Province.

The previous research conducted by B. A. Wibowo and his team[9] was about honey quality test equipment using a polarimeter and color sensor. In this study, the design of a polarimeter system and color sensor was used to measure the optical rotation and color values of natural cotton honey samples. The next research conducted by S. Rochman and his team[10] is about the quality classification of bee honey using a spectrophotometer system and machine learning based on a single board computer.

The purpose of this research is to produce recommendations to determine the quality of honey. The existence of this tool can make it easier to find out real honey or mixed honey. In this study, the honey quality test equipment used a gas sensor TGS 2602[11], [12] and a color sensor TCS 3200[13], [14]. The microcontroller used is nodeMCU ESP32. These two parameters are expected to be a reference whether the honey is natural or mixed.

II. MATERIALS AND METHODS

A. Materials

The equipment used in this study is classified into two types, namely software and hardware devices:

- Arduino IDE
- Website

Hardware :

- Personal Computer (PC) or Laptop
- *Microcontroller NodeMCU* type of *ESP 32*
- The color sensor of *TCS 3200*
- Gas sensor *TGS 2602*
- LCD 16x2
- Jumper cable with male to female type, *male to male* dan *female to female*
- Box

B. Honey Quality Tool Design

NodeMCU will process the data received from the color sensor and gas sensor. The colour sensor will display R.G.B (Read Green and Blue) data. At the value already in the sensor in honey, the gas sensor is processed through the ADC (Analog Digital Conversion) value[15][16]. Analog input converter into digital codes that have been designed so as to get a honey value. After the two data are processed, then the data will be sent to the website that has been designed.

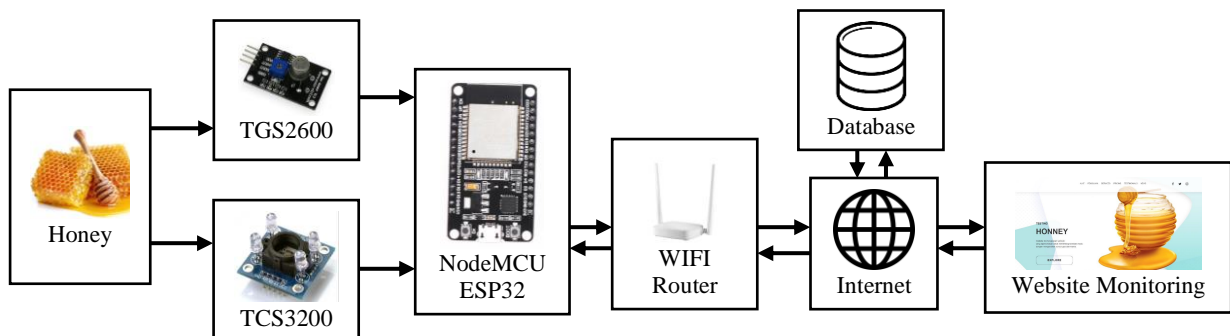

Figure 1. Block diagram of honey quality tool design

C. Desain System

C.1. Desain Hardware

Hardware that has been made for the development of a honey quality test equipment design system, there are two sensors used to conduct this research, namely the Gas sensor and the Color sensor, as shown in Figure 2. PC or (Personal Computer) number 1 to process the results of good data Input and output according to the wishes of the user (user), in the design of this system can display the results of the Website from the two sensors. Then there is NodeMCU32 (number 2) which is used as the center of consideration. NodeMCU32 is also a microcontroller and can translate data from analog signals to digital or vice versa. While the gas sensor TGS 2602 (number 3) from this tool has a good level of sensitivity and air selectivity to contamination levels of gases outside the room such as ammonia and H₂S and low concentrations of alcohol. The TCS 3200 Color sensor (number 4) is used for various needs, one of which is to find out how to analyze several color objects that are brought closer to the sensor to distinguish several types of selected color objects, to know how the color sensor works, so that the color sensor

can work according to color needs. which is obtained. The last one is Lcd (Liquid Cristal Display) (number 5) which has the function of Output pin display from the NodeMCU specifically for sending or receiving data that has been processed.

After all the data from the TCS2602 Sensor and the TGS3200 Sensor, the NodeMCU will process the data. Furthermore, this data will be sent to the Website. However, NodeMCU must first connect to the Wifi Router in order to send data to the Website. The function of the Wifi Router is as a NodeMCU connection to the internet.

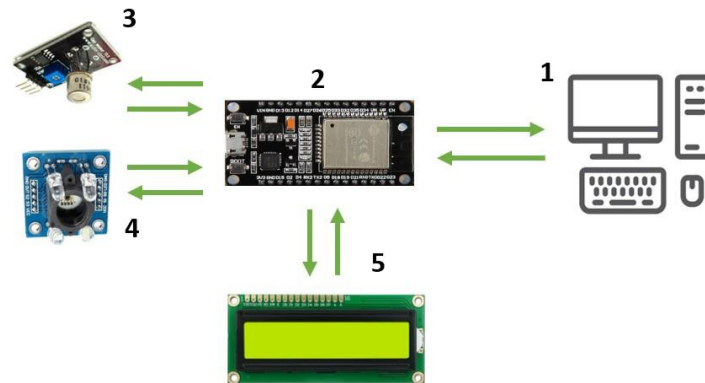

Figure 2. Hardware design

C.2. Electronic Circuit Design

In this design there is an electronic circuit consisting of NodeMCU 32, which acts as a microcontroller or can also be called the brain of an electronic circuit. NodeMCU Type "ESP32" functions in the process of receiving data from sensors, translating data from analog signals to digital or vice versa, can also give commands such as activating and deactivating sensors on honey, and can receive and send data to a website that has been created in advance. Then there is the TGS 2602 Gas sensor which functions to distinguish various types of honey from fake (imitation) honey. The TCS 3200 Color sensor is used for various needs, one of which is to know the analysis of several color objects that are brought closer to the sensor to distinguish several types of selected color objects, to know how the color sensor works, so that the color sensor can work according to the color needs obtained. Then there is the LCD (Liquid Crystal Display) which functions as a display output.

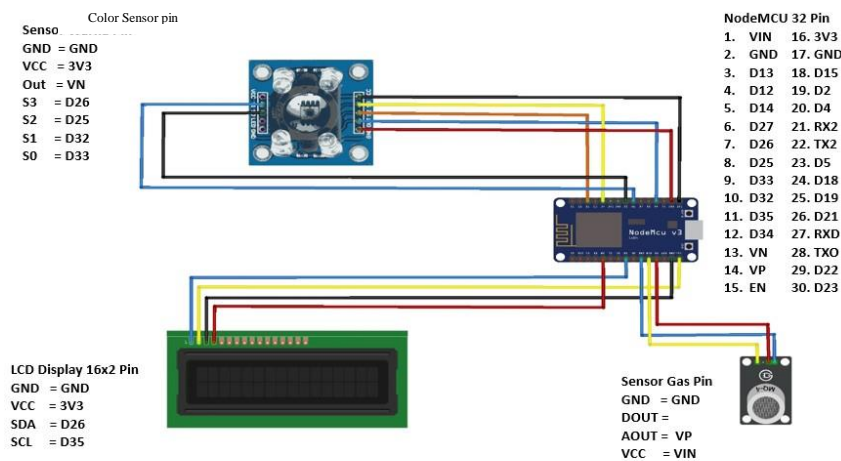

Figure 3. Electronic Circuit Design

C.3. Software Design

In Figure 4 shows the overall system workflow where the system initializes the gas sensor and color sensor first so that the sensor can be read in the NodeMCU. The next process is to detect the value of the gas sensor so that it can assess the value of the vapor or gas content in the honey, while the color sensor can determine the value for real or mixed honey. Then the data can be calculated to be changed from the sensor value to the percent value, then after the data, the next step is to determine the mixed honey, if 100% pure honey is divided into two to determine the comparison value for 80% pure honey and a mixture of water 20% while for real honey 20% and a mixture of 80% water. Then the two sensors will work to determine the results of the comparison. Then the two data will be sent to the website that has been created.

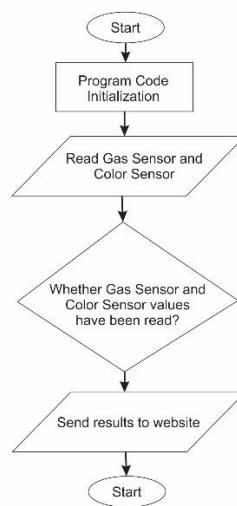

Figure 4. Software flowchart design

D. Website Design

In Figure 5 is the main display on the Website that has been designed to perform testing on the honey.

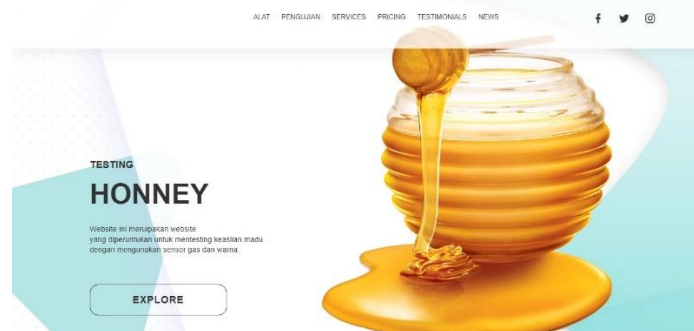

Figure 5. Website design

This website has been designed to access data or files from programs that are input from a PC to display output on this website and display the results of the gas sensor program and color sensor.

E. IP Address Design

The IP experience design of the internet of things-based honey quality test network on natural honey and mixed honey uses class C with a network address of 192.168.43.161/24.

III. RESULTS AND DISCUSSION

The initial system design will be implemented in real form and several tests will be carried out to find the system is working according to the initial design. After testing, the overall system that has been made is discussed.

A. Hardware Testing

After the assembly stage of the electronic circuit, further testing is conducted to determine which components of the electronic circuit, can function according to the initial plan. As seen on Figure 6.

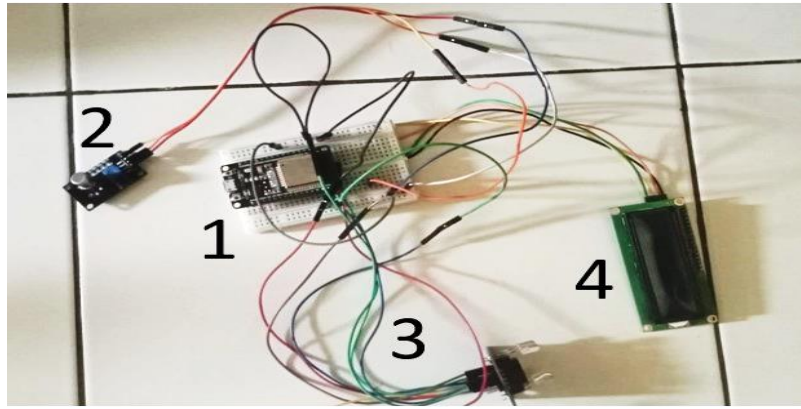

Figure 6. Hardware system implementation

The summary results of these statuses are shown in Table 1

Table 1. Electronic Component Testing

Component	Steps	Description
<i>NodeMCU</i>	<ol style="list-style-type: none"> 1. Connect to PC/Laptop 2. Open the ArduinoIDE app 3. Check device status 	Succeed
Gas Sensor <i>Tgs 2602</i>	<ol style="list-style-type: none"> 1. Connect to NodeMCU 2. Enter the program code into the NodeMCU via the ArduinoIDE application to read the sensor signal on the honey, 3. Open the website that has been created 	Succeed
Color Sensor <i>Tcs 3202</i>	<ol style="list-style-type: none"> 1. Connect to NodeMCU 2. Enter the program code into the NodeMCU via the ArduinoIDE application to read the color signal on the honey sensor, 3. Open the website that has been created 	Succeed
Original honey	<ol style="list-style-type: none"> 1. Honey that is not mixed 2. This honey has different color 	Succeed
mixed honey	<ol style="list-style-type: none"> 1. Honey that has a mixture of water percent (%) 2. Honey has less than viscosity 	Succeed

B. Test Result of TGS 2602 Sensor

Testing the gas sensor in clean air, the value of ADC and voltage aims to determine how much difference is obtained from the TGS 2602 gas sensor. The test is carried out in three mixing conditions: first, 20 % of honey, 80 % of water. Second, honey content is 80 %, and 20 % of water, and the third is pure honey content (100% honey). Tested 15 times for each condition of the honey mixture; the test results can be seen in Table 2.

Table 2. Test Result of Sensor TGS2602

Test Subject	Mixed of 20% honey and 80% water			Mixed of 80% honey and 20% water			Pure Honey		
	ADC	Voltage (V)	Clean Air (V)	ADC	Voltage (V)	Clean Air (V)	ADC	Voltage (V)	Clean Air (V)
1	3009	2.42	2.18	3314	2.67	2.33	3053	2.46	2.26
2	3019	2.43	2.18	3329	2.68	2.25	3662	2.95	2.26
3	3018	2.43	2.18	3344	2.69	2.34	4095	3.30	2.18
4	3028	2.44	2.18	3354	2.70	2.35	4095	3.30	2.18
5	3136	2.53	2.17	3360	2.71	2.26	4095	3.30	2.33
6	3140	2.53	2.33	3375	2.72	2.18	4095	3.30	2.33
7	3146	2.54	2.25	3378	2.72	2.18	4095	3.30	2.25
8	3137	2.53	2.34	3390	2.73	2.33	4095	3.30	2.26
9	3145	2.54	2.35	3314	2.67	2.35	4095	3.30	2.26
10	3142	2.53	2.26	3329	2.68	2.26	4095	3.30	2.18
11	3136	2.53	2.17	3344	2.69	2.18	4095	3.30	2.33

12	3140	2.53	2.33	3354	2.70	2.18	4095	3.30	2.25
13	3146	2.54	2.25	3360	2.71	2.33	4095	3.30	2.26
14	3137	2.53	2.34	3314	2.67	2.33	4095	3.30	2.26
15	3145	2.54	2.35	3375	2.72	2.25	4095	3.30	2.18

C. Test Result of TCS 3200 Sensor

The color sensor test aims to determine the color of the honey's color to determine the colour in the honey, including the clear or dark color category. The structure of determining color in honey is based on sensor readings, RGB to see sensor data readings on color sensors to identify and compare with RGB color composition with real honey or mixed honey, on the contrary, the lower the value read by the color sensor, the more we know real honey or mixed honey. This study changed the sensor value to a per cent value (%) to make the research easier. You can use the following formula to change the sensor value to a percent value. R.G.B : Red value = 209, Green value = 251, Blue value = 183.

Table 3. Test Result of Sensor TCS 3200

No	Distance								
	1 cm			2 cm			3 cm		
	R	G	B	R	G	B	R	G	B
1	156	189	144	173	202	149	200	176	239
2	165	194	151	172	203	151	210	183	248
3	173	191	144	170	205	154	209	185	251
4	166	192	158	169	204	155	208	183	249
5	165	200	150	175	202	154	206	183	247
6	163	199	159	173	203	153	206	182	246
7	166	203	143	172	204	152	205	183	246
8	170	192	149	174	203	156	204	181	247
9	169	189	153	172	201	155	208	182	248
10	170	190	150	175	202	154	205	183	249
11	156	189	144	173	202	149	200	176	239
12	165	194	151	172	203	151	210	183	248
13	173	191	144	170	205	154	209	185	251
14	166	192	158	169	204	155	208	183	249
15	165	200	150	175	202	154	206	183	247

Table 3 shows the results of the TCS 3200 sensor testing, the results of the more dominant R, G and B values are using a distance of 2 cm. For this reason, the author uses 2 cm of distance to find real honey and mixed honey.

The honey that has been designed will be plugged into the TCS 3200 color sensor for the color sensor test, which will revert the data to determine the category of the honey condition. The original honey category will be obtained by placing the honey in a container, and the mixed honey category will be obtained by separating it from the color placed in the container. The results of color sensor testing on the design of honey quality test equipment, they are seen in Table 4.5.

Table 3 shows the results of the TCS 3200 sensor testing. The results of the more dominant R, G and B values are using a distance of 2 cm. For this reason, the author uses 2 cm of blood to find real honey and mixed honey.

D. System Testing on Honey Quality Test Equipment Design

At this testing stage, the electronic circuit that has been completed will be tested directly on honey which aims to see the performance of the design system for the honey quality test equipment that has been assembled. Tests in this study were carried out from 08.00 WITA to 00.00 WITA with a data return range of every 2 (two) hours. The data collected will be utilized to assess the success of various honey-related systems. The research was conducted at the author's residence by placing honey in the container provided

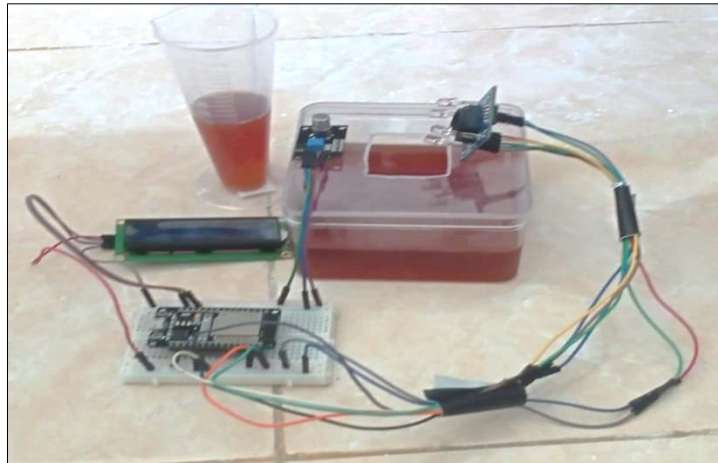

Figure 7. Testing of Honey Quality

Figure 7 is a container for honey and a series of test equipment to conduct research in testing pure honey and mixed honey. As previously explained, this test is carried out from July 2, 2022 to July 5, 2022, for 4 (four) days. The test will display the data from the readings of 2 (two) sensors, namely the gas sensor and the color sensor. The data from the test results will be sent to the website to be displayed in tabular form. Table 4 are the results of the data collected during this research.

Table 4. Overall System Performance Test Results

Honey Type	Test Subject	Gas Sensor		Color Sensor			Test Result
		ADC	Voltage (volt)	R	G	B	
Dorsata Honey	1	4095	3.30	201	175	239	Pure honey
	2	4095	3.30	210	183	248	Pure honey
	3	4095	3.30	209	184	251	Pure honey
	4	4095	3.30	200	176	238	Pure honey
	5	4095	3.30	208	183	249	Pure honey
	6	4095	3.30	206	185	250	Pure honey
	7	4095	3.30	199	172	238	Pure honey
	8	4095	3.30	208	182	240	Pure honey
	9	4095	3.30	209	184	249	Pure honey
	10	4095	3.30	206	181	250	Pure honey
Honey mixed sugar	1	3009	2.42	156	189	143	Mixed honey
	2	3019	2.43	165	193	149	Mixed honey
	3	3018	2.43	172	190	152	Mixed honey
	4	3028	2.44	156	188	148	Mixed honey
	5	3136	2.53	167	191	150	Mixed honey
	6	3140	2.53	170	193	149	Mixed honey
	7	3146	2.54	156	187	145	Mixed honey
	8	3137	2.53	165	190	158	Mixed honey
	9	3145	2.54	173	189	150	Mixed honey
	10	3142	2.53	154	196	149	Mixed honey

Display 10 results Search:



Nomor	ADC	Tegangan	Greyscale	Warna	Kandungan Air
1478	3839	3.09 Volt	2	.	Madu 80% Air 20%
1479	4047	3.26 Volt	2	.	Madu 80% Air 20%
1480	4073	3.28 Volt	2	.	Madu 80% Air 20%
1481	4095	3.3 Volt	2	.	Madu 100% Air 0%
1482	4095	3.3 Volt	2		Madu 100% Air 0%
1483	4095	3.3 Volt	2		Madu 100% Air 0%
1484	4095	3.3 Volt	2		Madu 100% Air 0%
1485	4095	3.3 Volt	2		Madu 100% Air 0%
1486	4095	3.3 Volt	2	.	Madu 100% Air 0%
1487	4095	3.3 Volt	2	.	Madu 100% Air 0%
Nomor	ADC	Tegangan	Greyscale	Warna	Kandungan Air

Figure 8. Website result

In Table 4 are the results of testing the system performance on July 5, 2022. From this test, it can be seen that the status of honey still shows the condition in a mixed honey state. Figure 8 shows the result of testing the tool's performance that has successfully been sent from the system to the website on the 4th day on honey. The test shows that the status of honey still shows the condition in a state of honey mixed with 20% sugar and 80% pure honey and the final test of 100% pure honey.

IV. CONCLUSION

Based on the results of the design and testing that has been done. It can be concluded that a honey quality tester using a gas sensor and color sensor has been successfully developed and implemented to assist consumers in choosing honey products. Based on the results of the experiments, the ideal distance for measurements is carried out as far as 2 cm. The success rate in testing pure honey with a mixture of honey has different values, such as the value of pure honey has a gas sensor voltage of 3.3 volts while the value of mixed honey with 50% pure honey and 50% sugar, the value of the gas sensor voltage is 2.54 volts. Mixed honey has a voltage below 3 volts. The results of the color sensor test, namely the sensor output has different values, the RGB value for pure honey is red 206, green 246, blue 182 while the RGB value for mixed honey is for 20% pure honey and 80% sugar mixture produces an RGB value of Red 156, Green 210, Blue 171. The color sensor can distinguish between real honey and mixed honey for trigona honey.

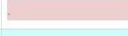
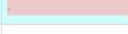
ACKNOWLEDGMENT

We would like to thank our colleagues who have assisted in this research.

REFERENCES

- [1] N. M. W. Sari, N. A. Trisantika, A. I. Mundiya, and D. Septiadi, "Financial Feasibility of Honey Bees Business at KPHL West Rinjani, West Nusa Tenggara," *AgriHumanis: Journal of Agriculture and Human Resource Development Studies*, vol. 1, no. 2, pp. 135–144, 2020, doi: 10.46575/agrihumanis.v1i2.76.
- [2] N. Gustina, K. Yuliaty, and S. Lestari, "Madu Sebagai Wet Batter Pada Produk Udang Breaded," *Fishtech - Jurnal Teknologi Hasil Perikanan*, vol. 4, no. 1, pp. 37–45, 2015.
- [3] P. Jose Vazhacharickal, "A review on health benefits and biological action of honey, propolis and royal jelly," *Journal of Medicinal Plants Studies*, vol. 9, no. 5, pp. 1–13, 2021, [Online]. Available: www.plantsjournal.com.
- [4] S. Terzo, F. Mulè, and A. Amato, "Honey and obesity-related dysfunctions: a summary on health benefits," *Journal of Nutritional Biochemistry*, vol. 82, 2020, doi: 10.1016/j.jnutbio.2020.108401.
- [5] T. C. Pimentel *et al.*, "Stingless bee honey: An overview of health benefits and main market challenges," *Journal of Food Biochemistry*, vol. 46, no. 3, pp. 1–21, 2022, doi: 10.1111/jfbc.13883.
- [6] E. Lika, M. Kostić, S. Vještica, I. Milojević, and N. Puvača, "Honeybee and plant products as natural antimicrobials in enhancement of poultry health and production," *Sustainability (Switzerland)*, vol. 13, no. 15, pp. 1–20, 2021, doi: 10.3390/su13158467.
- [7] G. Iliu, V. Simulescu, P. Merghes, and N. Varan, "The health benefits of honey as an energy source with antioxidant, antibacterial and antiseptic effects," *Science and Sports*, vol. 36, no. 4, pp. 272.e1–272.e10, 2021, doi: 10.1016/j.scispo.2020.10.005.
- [8] D. D. Wulandari, "Analisa Kualitas Madu (Keasaman, Kadar Air)," *Jurnal Kimia Riset*, vol. 2, no. 1, p. 16, 2017.
- [9] B. A. Wibowo, M. Rivai, and Tasripan, "Alat Uji Kualitas Madu Menggunakan Polarimeter dan Sensor Warna," *Jurnal Teknik ITS*, vol. 5, no. 1, pp. 28–33, 2016, doi: 10.12962/j23373539.v5i1.15251.

- [10] P. Seminar and N. Aplikasi, "Spektrofotometer Dan Machine Learning Berbasis Single Board Computer," *Prosiding Seminar Nasional Aplikasi Sains & Teknologi (SNAST)*, no. September, pp. 207–213, 2018.
- [11] A. T. John, K. Murugappan, D. R. Nisbet, and A. Tricoli, "An outlook of recent advances in chemiresistive sensor-based electronic nose systems for food quality and environmental monitoring," *Sensors*, vol. 21, no. 7, 2021, doi: 10.3390/s21072271.
- [12] A. Szczurek, M. Maciejewska, B. Bąk, J. Wilk, J. Wilde, and M. Siuda, "Gas sensor array and classifiers as a means of varroosis detection," *Sensors (Switzerland)*, vol. 20, no. 1, pp. 1–17, 2020, doi: 10.3390/s20010117.
- [13] I. E. Elemure, J. O. Akinyoola, A. M. Olawumi, A. E. Amoran, E. A. Oshin, and T. V Adebanwo, "Smart sorting method of grains using a colour sensor," *International Journal of Scientific Research & Engineering Trends*, vol. 5, no. 3, pp. 2395–566, 2019.
- [14] T. H. Budianto, "Analisa madu pada koloni lebah trigona berbasis arduino," *Prosiding Seminar Penelitian dan Pengabdian Pada Masyarakat*, vol. 3, no. 1, pp. 114–117, 2020.
- [15] I. N. S. A. Utama, S. Hadi, and I. P. Hariyadi, "Plume Detection System Based Internet of Things," *International Journal of Engineering and Computer Science Applications (IJECSA)*, vol. 1, no. 1, pp. 19–26, 2022, doi: 10.30812/ijeCSA.v1i1.1698.
- [16] S. Hadi and A. Adil, "Rancang Bangun Pendeteksi Gas Berbasis Sensor MQ-2," *Seminar Nasional Sistem Informasi dan Teknik Informatika (SENSITIF 2019)*, pp. 327–334, 2020.