



## PINEAPPLE LEAF FIBER REINFORCED POLYESTER COMPOSITE MODIFIED WITH PARTICLES FROM HORSE DUNG WASTE: CHARACTERIZATION OF MECHANICAL PROPERTIES AND MORPHOLOGY

Nasmi Herlina Sari<sup>1\*</sup>, Suteja<sup>1</sup>

<sup>1</sup>Mechanical Engineering Department, Faculty of Engineering, University of Mataram, Mataram, West Nusa Tenggara, Indonesia

\*Corresponding author

Email: [n.herlinasari@unram.ac.id](mailto:n.herlinasari@unram.ac.id)

**Abstract.** *The modification of the characteristics of natural fiber composites with components derived from abundant and environmentally beneficial horse dung waste has piqued interest. The purpose of this investigation was to see how adding horse dung particles (DN) to pineapple leaf fiber (DN)/polyester composites affected the results. To create new samples, different percentages of HF (5–30%) are utilized. Hand-layup method was used to create the DN/HF composite. The results revealed that adding 30% (vol. percent) HF to the composite improved elongation, flexural strength, and flexural modulus, while adding 5% (vol. percent) HF improved impact strength, tensile strength, and tensile modulus of elasticity. At 30% HF concentration, maximum flexural strength values of 63.91 5.1 MPa were recorded. The composite's fracture morphology revealed weak interfacial interactions between DN-polyester-HF, and particle accumulation.*

**Keywords:** *polyester; pineapple leaf fiber (DN); horse dung particles (HF); mechanical properties; SEM.*

### 1. Introduction

In recent years, the maximal exploitation of pineapple leaf fiber (DN) for the fabrication of composites has gotten a lot of attention. Low cost, entirely biodegradable, renewable, low energy for processing, good strength and modulus, lower environmental damage, light weight, dimensional stability, and so on are all advantages of DN over other fibers [1-4]. To improve the characteristics of the polymers, DN derived from plants was utilized as a filler [2-3, 5-6]. In recent years, some studies reported the use of pineapple fiber to produce value-added products [7-9]. Compared to other natural fibers, DN has a higher cellulose content, superior mechanical and thermal properties [10-12]. Mathew et al. [13] discussed the mechanical properties and the possibilities of DN as a reinforcement for concrete. It was observed that DN dispersed in the concrete and increases the mechanical strength of the composite, but the ductility decreases in the presence of DN. Anonaba et al. [14] were investigated the thermal properties of pineapple stalk composite. It was observed that pineapple stalk sheet has lower

thermal conductivity than asbestos which is efficient when used as a “cool roof” building material. Further, the extracted DN for reinforcement of epoxy composites. They found that the flexural strength of the epoxy composites increased significantly when the fibers were straight and long in the composites [15]. Several other authors have studied the pineapple leaf fiber composites. The use of pineapple leaf fiber/carbon black-hybrid reinforcement can increase the performance of natural rubber composites. At low strains and in the high strain area, adding carbon black to a hybrid composite changes the stress versus strain curve [16]. Pistachio shell particles have an effect on the mechanical characteristics of a chopped glass fiber/epoxy composite. The addition of 1% weight of pistachio shell particle improved flexural strength by 14% [17].

Several authors have reported research on horse dung waste in the literature. Several consumers are probably using horse manure waste as a fuel substitute for kerosene and firewood [18]. Apart from being used as biomass, safely, horse dung is only used as manure. The potential of horse waste which is abundant and environmentally friendly needs to be utilized so that it can have added value and for wider applications. One of the efforts to increase the added value of horse dung waste is to utilize the waste into composite reinforcing particles.

Like other natural elements, horse dung is known to contain cellulose, hemicellulose, and lignin because the food comes from various types of grass such as *Brachiaria Mutica* and *Pinacium Maximum* [19]. Thus, this horse dung waste was developed as a composite filler with the desired properties.

Therefore, the goal of this research was to find out what the mechanical and morphological characteristics of a pineapple leaf fiber composite that had been modified with horse dung waste constituted. Using the hand lay-up technique, the composites were created by adding 5, 10, 25, and 30 (vol. percent) different horse dung particles. The effect of horse dung content on the tensile, impact, and flexural strength properties, as well as the morphology of composites, was investigated in depth in this work.

## 2. Materials and methods

### 2.1. Materials

Pineapple leaves of the *Ananas Cosmosus* species (Figures 1a and 1b) were obtained from Kuta village, Central Lombok district (NTB) Indonesia. Pineapple leaves were selected to be old ( $\pm 1$  year) to obtain fiber uniformity. Furthermore, filler in the form of horse dung collected from horse breeders' stables in West Lombok.

The unsaturated polyester (UP) resin utilized in this investigation was acquired from PT Justus Kimia Raya Surabaya, Indonesia. As a curing catalyst, use methyl ethyl ketone peroxide (MEXPOSE) at a concentration of 1-2 percent of the resin volume. The viscosity of the polyester is 6–8 (25 °C), the tensile strength is 8.8 Kg/mm<sup>2</sup>, the density is 1.9 gr/cm<sup>3</sup>, and the melting temperature is 110–200 °C [20].

## 2.2. Extraction of Pineapple leaves fiber

The selected Pineapple leaves (Figure 1c) are cleaned and then soaked in a bucket for approximately 15 days to undergo natural decay with bacteria to facilitate fiber extraction (Figure 1d). Next, the pineapple leaves are combed manually to separate the fibers from the flesh (see in Figure 1e). They are rinsed with fresh water, then directly dried in the sun. DN is ready to be used as a composite reinforcement as shown in Figure 1f.

Next, horse dung was cleaned and rinsed using freshwater five times, as shown in Figure 2a. They were then daylight for 2-3 days (Figure 2b) before being sieved using a 50-mesh sieve to obtain a consistent particle size (297 m) (Figure 2c). As illustrated in Figure 2d, HF particles are ready for use in the manufacture of composites.



Figure 1. The extraction process of pineapple leaf fibers, a) and b) pineapple plant, c) pineapple leaf, d) soaking leaves in water, e) combing the leaves to pick up the fiber, and f) pineapple leaf fiber



Figure 2. Extraction process of Horse dung particle, a) horse dung (HF), b) HF dried, c) sieving process, and d) HF particles.

### 2.3. Alkaline treatment of DN and HF.

The alkalization process carried out using DN and HF is shown in Figures 3 and 4. DN and HF were immersed in a NaOH solution with a concentration of 8% for 2 h, then, they were rinsed with running water until clean to ensure that no residual NaOH solution remained on the fibers or particles. Then, they are dried in the sun and stored in airtight plastic, and ready to be used in composites.

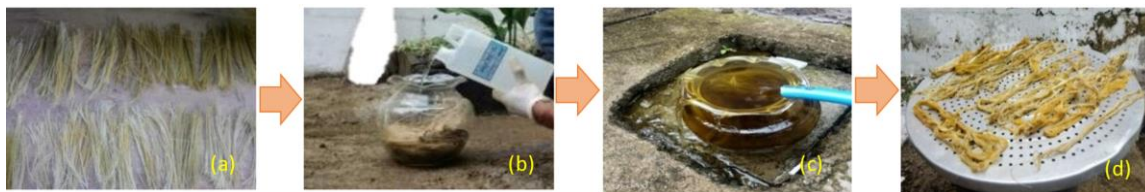

Figure 3. NaOH treatment process on DN, a) DN raw, b) Pouring NaOH solution on DN, c) Immersion of DN in NaOH for 2 h, and e) Drying the fiber in the sun



Figure 4. NaOH treatment process on horse dung particles, a) HF raw, b) Soaking fiber in NaOH solution for 2 h, c) HF rinse using water, and particle HF.

## 2.4. Composite Manufacturing

The composite was made by the hand lay-up method [19]. Before the manufacturing process, the DN and HF fiber composites were oven-baked for 1 h at a temperature of 105 °C to ensure that there was no moisture. Meanwhile, the polyester matrix was mixed with HF and stirred manually, then a catalyst (Mexpose) was added with a volume fraction of 1% of the matrix volume. The dough is poured into a mold that has been filled with DN and covered with a steel flat. The curing process was carried out for 12 h at room temperature. There are four different types of composites (see Table 2) with five repetitions each for each condition.

Table 2. The ratio of DN and HF in a polyester composite

| No. | Composite codes | Vol. fraction               |                |               |
|-----|-----------------|-----------------------------|----------------|---------------|
|     |                 | pineapple leaves fibers (%) | Dung horse (%) | Poliester (%) |
| 1   | KA              |                             | 5              | 85            |
| 2   | KB              | 10                          | 10             | 80            |
| 3   | KC              |                             | 25             | 65            |
| 4   | KD              |                             | 30             | 60            |

## 2.5. Characterization of composites

### 2.5.1 Impact test

The ASTM D256 standard was used to conduct the impact test. The sample is 63 mm x 12.7 mm x 3 mm in size (Figure 5a). To determine the impact toughness of the composite, the impact Charpy testing machine model IT-30 technique was used. The quantity of energy absorbed during the sample fracture was measured in joules.

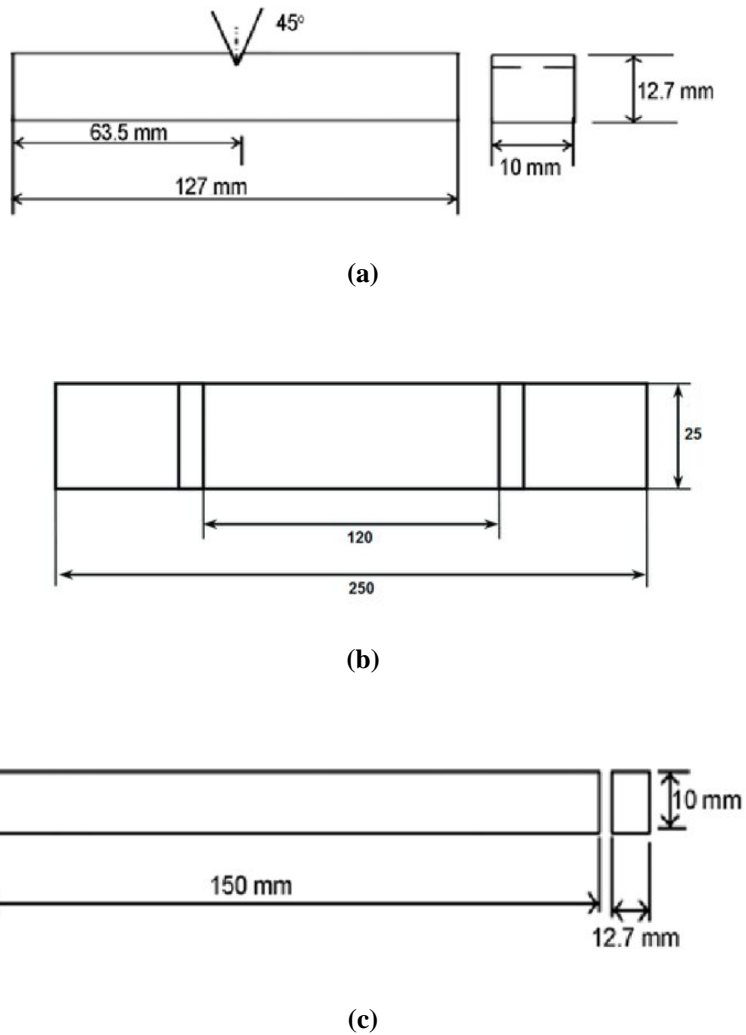

Figure 5. The composite sample's shape and dimensions, (a) impact, (b) tensile, and (c) flexural tests.

### 2.5.2 Tensile and Flexural properties

The tensile and flexural characteristics of the composites were measured according to ASTM D 3039 and ASTM D790 standards at room temperature of 26 °C and humidity of 61% using an electromechanical universal testing machine (UTM) Comtech QC-601T, Taiwan. The tensile test samples were 250 mm x 25.4 mm x 6 mm (Figure 5b) and 150 mm x 25.4 mm x 6 mm (Figure 5c), respectively, according to the ASTM D 3039 standard [20]. For each condition, at least five measurements of each sample were tested.



### 2.5.5. SEM analysis

The morphology of the DN/HF composites was studied using scanning electron microscopes. At a 144-emission current of 47A and an accelerating voltage of 1–5 kV, the SEM was tested on cryo-fractures. Using a Q150R PLUS sputter coater, the samples were sputter coated with 1 nm gold thickness. The image has been magnified in order to improve visual clarity.

## 3. Result and discussion

### 3.1 Impact strength

Figure 6 depicts the DN/HF composite's impact strength. The impact strength of the composite was found to be reduced than the composite with 5% HF by 5.89 %, 24.9 %, and 42.3 %, respectively. The highest impact strength was obtained from the KA sample of  $6.11 \pm 0.42$  kJ/m<sup>2</sup>, and the lowest was obtained from the KD sample of  $3.53 \pm 0.48$  kJ/m<sup>2</sup>. The decrease in impact strength because a large number of DN and HF cannot be wetted by polyester, causing trapping of voids in the composite, as a result, the interface bond between DN-HF-polyester becomes weak, and ultimately the impact strength is reduced [21, 22]. On the other hand, when the amount of HF is low, the interface bonds are strong enough, and thus the impact strength is high. The impact strength of the composite can decrease because the fibers used are shorter than the critical length [23].

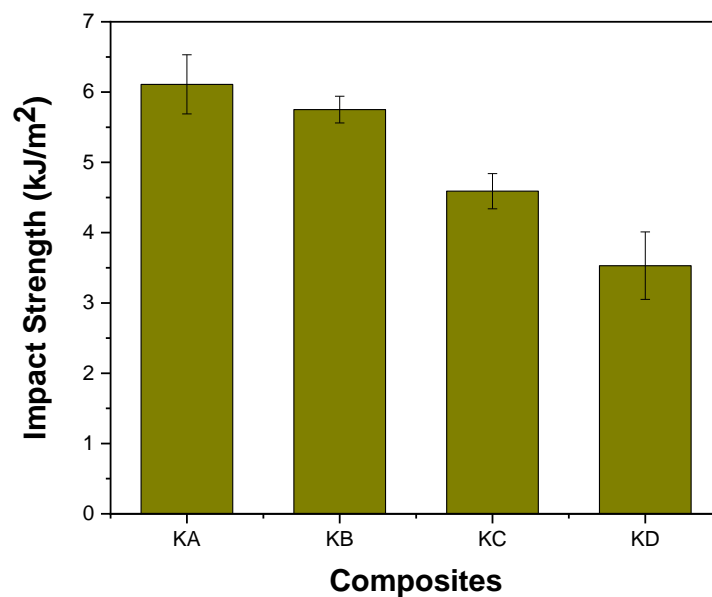

Figure 6. Impact strength of polyester-DN/HF composite

### 3.2 Tensile strength analysis

Figure 7 depicts the effect of horse dung particles (HF) on the mechanical characteristics of DN composites. The amount of HF content employed ranged from 5, 10, 25, and 30% (vol. %). The tensile strength of the composites decreased as the HF was increased, possibly due to the dewetting effect [24]. With the addition of HF, the Young's modulus and elongation increase, with maximum values of  $1.96 \pm 0.19$  GPa and  $0.96 \pm 0.14$  respectively, were recorded at 30% HF content (Figure 8). The addition of fibers increases the rigidity of the composites, as measured by the rise in Young's modulus [9, 25]. The enhanced aspect ratio of the HF is responsible for the increase in mechanical characteristics. The aspect ratio of the HF is a critical component in determining the composites' mechanical performance [7,26].

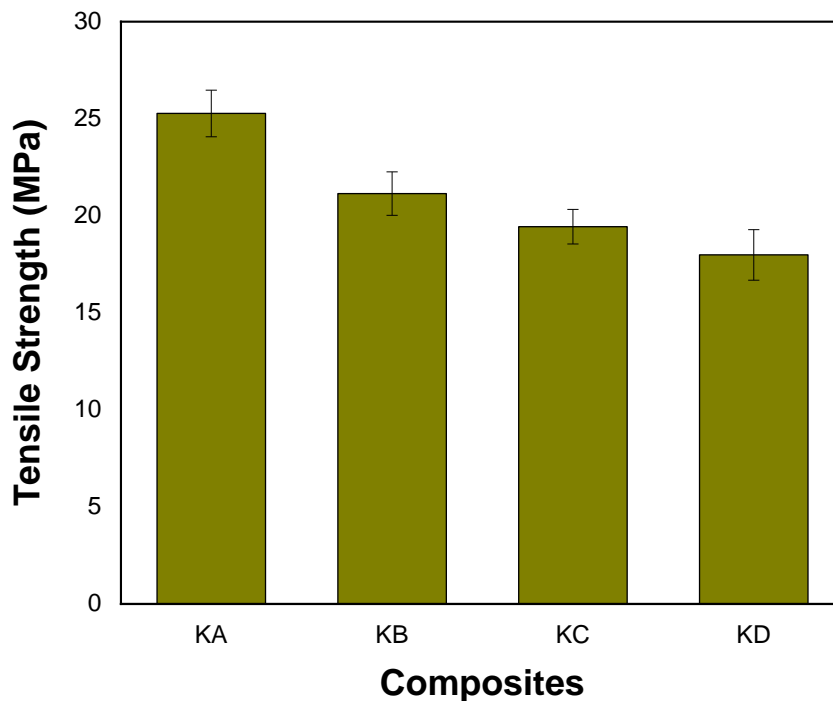

Figure 7. Tensile strength of polyester-DN/HF composite



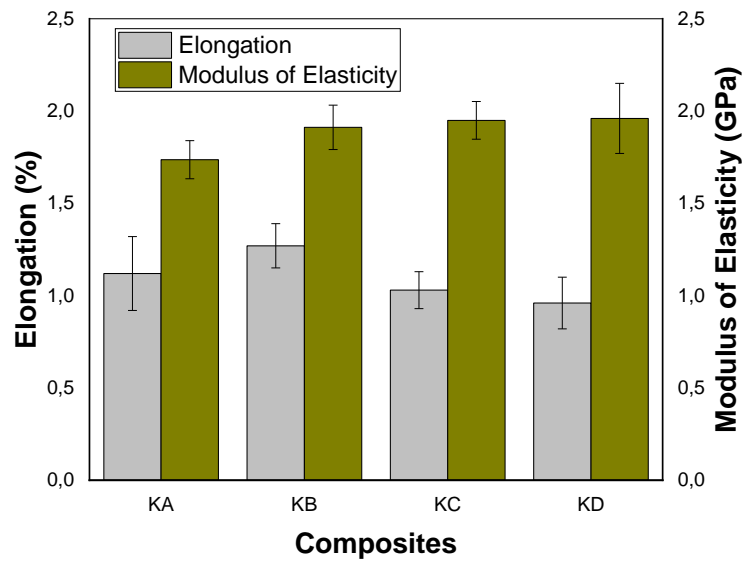

Figure 8. Elongation and modulus of elasticity of polyester-DN/HF composite

### 3.3. Flexural strength analysis

The flexural strength of a polyester-DN composite with HF filler is shown in Figure 9. The flexural strength of the composites improved as the HF component was increased. This finding is inversely proportional to the tensile test results, which show a considerable increase in flexural strength of the composite in the range of 16.3 % to 37.8 % of the KA sample. The highest strength was obtained from the KD sample of  $63.91 \pm 5.1$  MPa. The uniform distribution of the HF filling between the DN and polyester, which controlled the stiffness and flexural strength of the sample, was responsible for this increase. Furthermore, the use of the HF filler increases the bonding between the composite constituents, resulting in higher flexural strength [11, 27, 28]. The value of the flexural modulus of the composite also increased (Figure 10), indicating that the composite was stiffer with increasing HF in the composite.

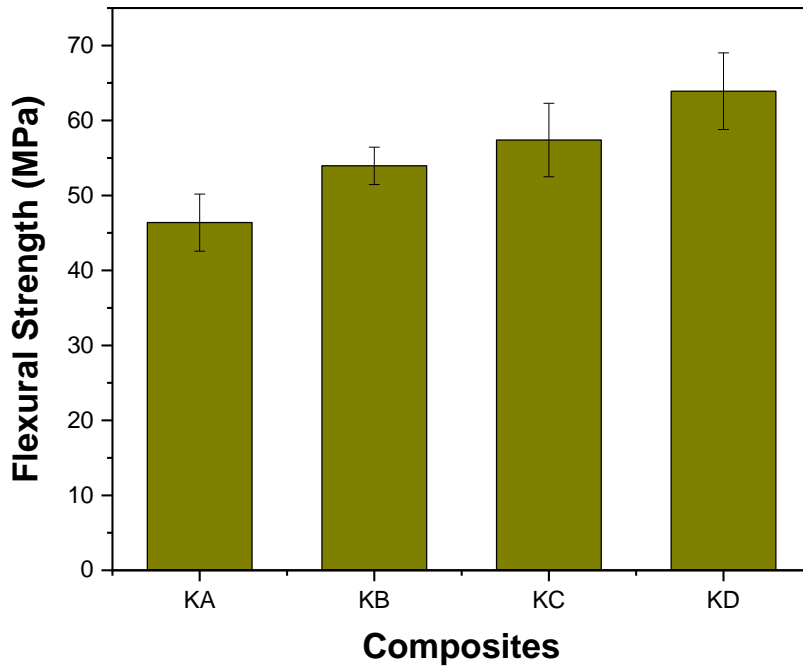

Figure 9. Flexural strength of polyester-DN/HF composite

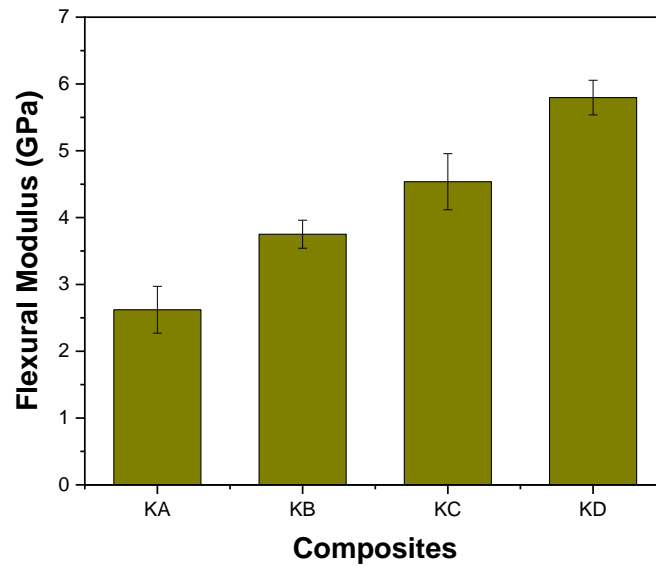

Figure 10. Flexural modulus of polyester-DN/HF composite

#### 4.3. Morphology of the polymer composites

The SEM micrographs of the DN/HF composite are shown in Figure 11. The SEM images show HF and DN dispersion as well as filler-matrix adherence. Figure 11a shows a

pretty strong interfacial bond between DN-HF-polyester, which helps to explain why the KA sample has such a high tensile strength. Figures 11b, 11c, and 11d, on the other hand, show a relatively weak interface between DN-polyester-HF and the presence of some voids formed between fibers and particles as the HF content in the composite increases, confirming the reason that the composite's tensile strength decreases as the number of HF increases.

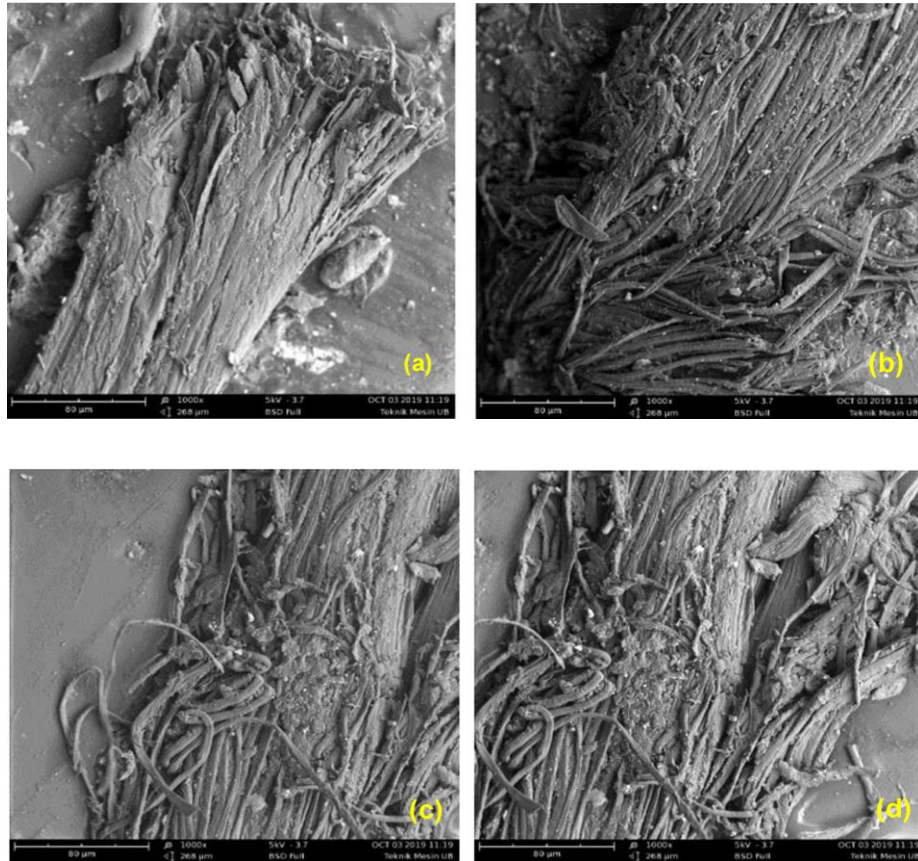

Figure 11. SEM image of composites sample, a). KA, b) KB, c) KC, and d) KD

## 5. Conclusion

The mechanical and morphological properties of DN composites with HF filler have been studied experimentally. The tensile and impact strength of the composite dropped when the interface bond between polyester-DN-HF became weak due to the dewetting effect, according to the findings. The composites' elongation, flexural strength, and flexural modulus, on the other hand, rose as the HF increased. The DA samples with the greatest values of elongation, flexural strength, and flexural modulus were 1.96 0.19, 63.91 5.1 MPa, and 5.79 0.26 GPA, respectively. The presence of an aggregation of DN and HF particles, as well as a less dense interface, was revealed by morphological analysis of composite fractures. Our

laboratory is conducting more research on environmental assessment and the potential use of horse dung particle-reinforced polymer composites for various applications.

### Acknowledgments

For laboratory assistance, the authors are grateful to the Mechanical Engineering Department, Faculty of Engineering, University of Mataram.

### References

- [1] N. Kumar, J. S. Grewal, S. Kumar, N. Kumar and K. Kashyap, "Mechanical and thermal properties of NaOH treated sisal natural fiber reinforced polymer composites: Barium sulphate used as filler," *Materials Today: Proceedings*, vol. 45, no. 6, pp. 5575-5578, ISSN 2214-7853, 2021. <https://doi.org/10.1016/j.matpr.2021.02.310>.
- [2] C. Sivakandhan, G. Murali, N. Tamiloli and L. Ravikumar, "Studies on mechanical properties of sisal and jute fiber hybrid sandwich composite," *Materials Today: Proceedings*, vol. 21, no. 1, pp. 404-407, ISSN 2214-7853, 2020. <https://doi.org/10.1016/j.matpr.2019.06.374>.
- [3] P. D. Setyawan, N. H. Sari and D. G. P. Putra, "Pengaruhorientasi Danfraksi Volume Serat Daun Nanas (Ananas Comosus) Terhadap Kekuatan Tarik Komposit Polyester tak Jenuh (Up)", *Dinamika Teknik Mesin*, vol. 2, no. 1, pp. 1-6, 2012.
- [4] J. R. Chianelli, J. M. L. D. Reis, J. L. Cardoso and P. F. Castro, "Mechanical characterization of sisal fiber-reinforced recycled HDPE composites." *Mat. Res*, vol. 16, no. 6, pp. 1393–1397, 2013.
- [5] S. Kumar, M. S. Shamprasad and Y. S. Varadarajan, "Experimental investigation of impact strength and hardness value of rice straw reinforced polylactide composites," *Materials Today: Proceedings*, ISSN 2214-7853, 2021. <https://doi.org/10.1016/j.matpr.2021.10.038>.
- [6] C. Ngaowthong, M. Borůvka, L. Běhálék, P. Lenfeld, M. Švec, R. Dangtungee, S. Siengchin, S. M. Rangappa and J. Parameswaranpillai, "Recycling of sisal fiber reinforced polypropylene and polylactic acid composites: Thermo-mechanical properties, morphology, and water absorption behavior, *Waste Management*", vol. 97, pp. 71-81, ISSN 0956-053X, 2019. <https://doi.org/10.1016/j.wasman.2019.07.038>.
- [7] A. Bourmaud, A. Le Duigou and C. Baley, "What is the technical and environmental interest in reusing a recycled polypropylene–hemp fibre composite? *Polym.*" *Degrad. Stab*, vol. 96, no. 10, pp. 1732–1739, 2011.
- [8] R. A. Singh, "A Different Approach towards Textile by Pineapple Fiber." *Asian Journal of Multidisciplinary Studies*, vol. 5, no. 9, September, 2017.
- [9] P. K. Bajpai, I. Singh and J. Madaan, "Comparative studies of mechanical and morphological properties of polylactic acid and polypropylene based natural fiber composites." *J. Reinf. Plast. Comp.* vol. 31, no. 24, pp. 1712–1724, 2012.
- [10] M. Jawaid and A. H. P. S. Khalil, "Cellulosic/synthetic fibre reinforced polymer hybrid composites: a review." *Carbohydr Polym*, 86, pp. 1–18, 2011.

- [11] R. V. S. Reddy, L. R. Jeeru, P. V. Reddy and K. Swamy, "Mechanical Properties Evaluation of Pomegranate Peel Powder Filled Jute Fiber Reinforced Epoxy Composites, *Materials Today: Proceedings*", 2021. <https://doi.org/10.1016/j.matpr.2021.12.043>.
- [12] A. L. Leão, B. M. Cherian, S. Narine, S. F. Souza, M. Sain, and S. Thomas, "The use of pineapple leaf fibers (PALFs) as reinforcements in composites." *Biofiber Reinforcements in Composite Materials*, pp. 211-235, 2015. <https://doi.org/10.1533/9781782421276.2.211>.
- [13] L. Mathew and M. M. Paul, "Mechanical Properties of Pineapple Fibre Reinforced Concrete Subjected to High Temperature." *GRD Journal for Engineering*, vol. 2, Issue 5, April 2017 ISSN: 2455-5703, 2017.
- [14] A. U. Anonaba, U. S. Mbamara, and E. C. Mbamala, "Thermal Properties of Pineapple Leaf Composite and Its Suitability as A Viable Alternative for Efficient Roofing Material." *To Physics Journal*, vol. 4, ISSN: 2581-7396, 2019. <http://www.purkh.com/index.php/tophy>.
- [15] G. O. Glória, M. C. A. Teles, A. C. C. Neves, C. M. F. Vieira, F. V. D. Lopes, M. A. Gomes, F. M. Margem and S. N. Monteiro, "Bending test in epoxy composites reinforced with continuous and aligned PALF fibers." *Journal of Materials Research and Technology*, vol. 6, Issue 4, pp. 411-416. October–December 2017. <https://doi.org/10.1016/j.jmrt.2017.09.003>.
- [16] K. Yantaboot and T. Amornsakchai, "Effect of preparation methods and carbon black distribution on mechanical properties of short pineapple leaf fiber-carbon black reinforced natural rubber hybrid composites." *Polymer Testing*, 61, pp. 223-228, 2017.
- [17] A. K. Thiagarajan, P. Velmurugan, and P. Sangeeth, "Synthesis and mechanical properties of pistachio shell filler on glass fiber polymer composites by VARIM process, *Materials Today: Proceedings*," vol. 39, no. 1, pp. 610-614, 2021.
- [18] Y. A. Padang, N. H. Sari, N. Nurchayati, A. A. A. Triadi, Y. A. Sutaryono, and M. Muharman, "Biomassa dan bioarang dari limbah kotoran kuda tanpa dan dengan perlakuan menggunakan sodium hidroksida: studi nilai kalor dan kadar abu," *Dinamika Teknik Mesin*, vol. 10, no. 2, pp. 95-102, 2020.
- [19] A. Fariswan and Sugiyono, "Manajemen Pakan Kuda Pacu Di Tombo Ati Stable, Salatiga." *Tugas Akhir, D3 Kesehatan Hewan*, Universitas Gadjah Mada, 2014.
- [20] N. H. Sari, P. D. Setyawan, S. M. K. Thiagamani, S. Suteja, R. Tamimi, S. M. Rangappa, and S. Siengchin, "Evaluation of mechanical, thermal and morphological properties of corn husk modified pumice powder reinforced polyester composites, *Polymer composites*" 2022. <https://doi.org/10.1002/pc.26495>.
- [21] P. Jagadeesh, V. S. H. Ningappa, M. Puttegowda, Y. G. T. Girijappa, S. M. Rangappa, M. R. Khan, I. Khan, and S. Siengchin, "Pongamia pinnata shell powder filled sisal/kevlar hybrid composites: Physicomechanical and morphological characteristics." *Polymer Composites*. 2021. doi: <https://doi.org/10.1002/pc.26160>.
- [22] P. Chandra and S. R. Benin, "Study on the influence of barium sulphate on flexural and impact strength of simple natural fiber composite, *Materials Today: Proceedings*," 2021, ISSN 2214-7853, 2021. <https://doi.org/10.1016/j.matpr.2020.12.408>.

- [23] R. Hemanth, M. Sekar and B. Suresha, "Effects of Fibers and Fillers on Mechanical Properties of Thermoplastic Composites." *Indian Journal of Advances in Chemical Science*, vol. 2, pp. 28-35, 2014.
- [24] S. L. Favaro, T. A. Ganzerli, C. A. G. V. de Neto, , O. R. R. F. Da Silva, E. Radovanovic, "Chemical, morphological and mechanical analysis of sisal fiberreinforced recycled high-density polyethylene composites." *Express Polym. Lett*, vol. 4, no. 8, pp. 465–473, 2010.
- [25] A. Bourmaud and C. Baley, "Rigidity analysis of polypropylene/vegetal fibre composites after recycling." *Polym. Degrad. Stab.* Vol. 94, no. 3, pp. 297–305, 2009.
- [26] M. D. Iran, K. Sukruth, H. K. Govindaraju and Y. B. R. Lokesh, "Tensile and impact strength of nickel coated short carbon fiber reinforced polyester composite," *Materials Today: Proceedings*, 2021, ISSN 2214-7853, 2021. <https://doi.org/10.1016/j.matpr.2021.10.481>.
- [27] S. Signetti, F. Bosia, S. Ryu and N. M. Pugno, "A combined experimental/numerical study on the scaling of impact strength and toughness in composite laminates for ballistic applications, *Composites Part B: Engineering*," vol. 195, 108090, ISSN 1359-8368, 2020. <https://doi.org/10.1016/j.compositesb.2020.108090>.
- [28] N. H. Sari, "Kekuatan mekanik komposit diperkuat serat alam selulosa," *Dinamika Teknik Mesin*, vol. 8, pp. 51–56, 2018.