

Design and Development of Gas Leakage Monitoring System

using Arduino and ZigBee

Huan Hui Yan

Faculty of Electrical and Electronics Engineering
Universiti Malaysia Pahang Kampus Pekan, 26600 Pekan,
Pahang Darul Makmur.
yenyen1011@hotmail.com

Yusnita Rahayu

Faculty of Electrical and Electronics Engineering
Universiti Malaysia Pahang Kampus Pekan, 26600 Pekan,
Pahang Darul Makmur.
vannebula2001@yahoo.com

Abstract—Gas leakage in industrial area causes many health issues. Thus, to prevent such disasters happen, the atmosphere of a workplace should be regularly monitored and controlled, in order to maintain the clean air environment. However, efforts in industrial air quality control have been impeded by the lack of science-based approaches to identify and assess atmosphere air quality and level of dangerous gas. Therefore, a monitoring system for gas leakage detection needs to be developed. For the development of this system, the combustible gas sensor (MQ9) was used in order to detect the present of methane (CH₄) and carbon monoxide gas (CO). This sensor will detect the concentration of the gas according to the voltage output of sensor and operated in the alarm system, autonomous control system and monitoring system by using Arduino uno as the microcontroller for the whole system. Whereas the Zigbee will send the data reading from the gas sensor to monitoring system that display on LabVIEW Graphical User Interface (GUI). Besides, user can take immediate action upon the leakage occurs, else the gas supply and the system will shut down automatically within 10 minutes to prevent the condition becoming worst.

Index Terms—Gas leakage detection, Monitoring system, LabVIEW, Arduino, ZigBee, Gas sensor.

I. INTRODUCTION

In our daily life, the environment and its condition is very important for our health as it will impact the quality of life for all of earth's inhabitants. Consequently, the issues from environment and the air quality in industrial area are discussed to increase the alertness and responsibility regarding the environment towards public and workers' health. The dangerous gases such as CH₄, and CO will bring harmful effect towards human as they may cause explosions and CO poisoning accident in most industrial areas.

Thus, a gas detector is invented to ease human on detecting the presence of those dangerous gases within an area to prevent disaster happen. Nowadays, the gas detector has been innovated into various ways of detection, for example infrared thermal imaging gas leak detection [1], gas leakage detection with monitoring system [2], and wireless

gas sensor network [3]. This paper presents the design and development of a wireless gas leakage monitoring system by using Arduino and Zigbee.

In this project, the monitoring system is developed by using LabVIEW GUI. It is used to display the level of gas concentration in a place through another remote PC, and via internet server. Hence, it provides benefit to monitor the condition of a room in a safe distance.

Traditionally, the gas pipeline leakage monitoring system is realized by communication cable system, therefore the cost of installation and maintenance are very expensive and difficult as mentioned by J.Ding [4]. In order to overcome these restrictions, wireless sensor network is chosen as the best choice in the situation above. Some papers proposed different types of wireless sensor network such as radio frequency (RF) transceiver [3], router and coordinator [5], general packet radio service (GPRS) network [6] and Zigbee [2][4][7][8]. Nowadays, Zigbee is widely used in the gas leakage monitoring application field for the real-time monitoring of the potential risk areas.

For the autonomous control system is as a preventive way to stop the situation becoming worst by shutting down the process automatically. A. Shrivastava [9] has proposed the system by using stepper motor to turn off the main power and the gas supply. Whereas in this model, the relay switch is used to turn off the main power, and the electronic gas valve is used to turn off the gas supply. At the end, when the gas leakage is successfully stopped then the whole system will return to initial stage with the help of reset button.

II. DESIGN OVERVIEW

A. System traits

The distance measured is probably 0 units of measurement from the interior sensor. It does not use radiated or reflected spectral analysis. The distance to detect the gas is not easy to determine, but it has a detect range of 200 to 10000ppm. It depends on a few variables such as gas source, leakage rate, room size, air currents and sensor

placement. Thus, this model is designed in portable and it can be placed near to the gas pipeline. In Fig. 1 shows the design of the sensor location which is place in the room.

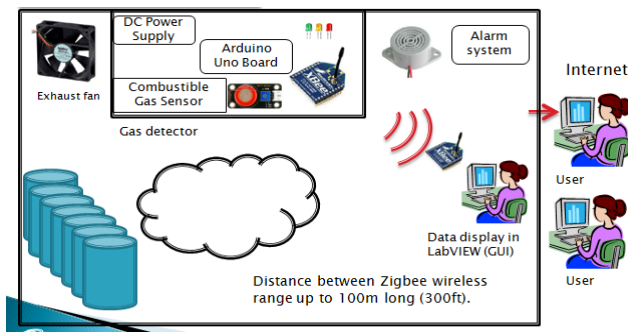

Fig. 1. The design of the sensor location.

B. Hardware approach

In this project there are two Arduino boards will be used as shown in Fig. 2. This microcontroller consists of built-in analogue-digital converter (ADC), which able to read the analogue signal from the combustible gas sensor MQ-9.

1) Block diagram of the model

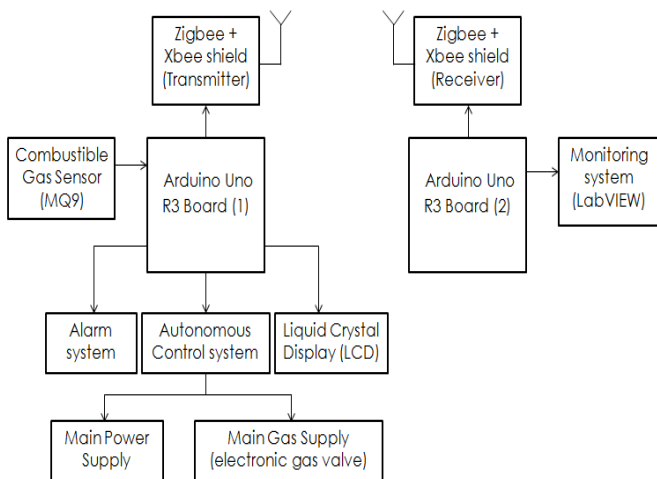

Fig. 2. Block diagram of the wireless gas leakage monitoring system.

From this figure, Arduino (1) is connected to the alarm system, control system, display system (LCD) and Zigbee transmitter. On the other hand, Arduino (2) is connected to monitoring system and Zigbee receiver only. When the gas leakage is detected by the combustible gas sensor MQ-9, the analogue signal is converting into digital signal with the ease Arduino (1) built-in conversion. Then the processing signal is transmitted through Zigbee transceiver to the LabVIEW GUI.

2) Threshold value

Meanwhile, Arduino (2) will receive the data and compare to the threshold value of the gas concentration based on the standard value from Occupational Safety and

Health Administration (OSHA) organization [2]. Table I shows the threshold value for gas concentration of CO and CH4 in parts per million (ppm). Whereas for Table II, represents the measured threshold value for the MQ-9 using Liquefied Petroleum Gas (LPG) [2].

TABLE I. THRESHOLD VALUE FOR GAS CONCENTRATION OF CO AND CH4 GASES [10]

Value of gas concentration (ppm)	
Carbon monoxide CO	Methane CH4
20 - 2000	500 - 10000

TABLE II. OSHA MEASURED VALUE FOR MQ-9 USING LPG [2]

Level	Light Indicator	LPG (ppm)	Sensor value in MQ-9	Voltage (V)
Safety	Green	<500	<342	<1.67
Precaution	Yellow	>= 500 <= 1000	>= 342 <= 512	>=1.67 <=2.50
Dangerous	Red	> 1000	> 512	>2.50

Based on the Table II, when the gas concentration value is below the threshold value (less than 342), the green indicator light is turn ON which represents safety mode.

Else if it is in between the threshold value of 342 and 512, the yellow indicator light is turning ON which represents precaution mode. At the same time, the exhaust fan is triggered to ventilate the leakage gas from the room. In the worst case, when the gas concentration is above the threshold values (more than 512), the red indicator light is ON; the alarm system is triggered to alert the users that the level of gas concentration is in the dangerous condition. After 10 minutes, if there is no action taken from the users, the main power supply and the gas supplies will shut down automatically as the function of autonomous control system to prevent the condition getting serious. In addition, users are able to stop the process of the system manually during emergency period.

3) Microcontroller

Arduino Uno R3 is a device that acts similarly to a microcontroller unit. In this project, Arduino is the perfect microcontroller due to its high performance and special features. The Arduino is an open-source electronic prototyping platform based on flexible, easy-to-use hardware and software. It has 14 digital input or output pins (of which 6 can be used as PWM outputs), 6 analog inputs, a 16MHz crystal oscillator, a USB connection, a power jack, an ICSP header, and a reset button. It contains everything needed to support the microcontroller; simply connect it to a computer with a USB cable or power it with a AC-to-DC adapter or battery to get started. The focus of the project is on the programming of Arduino. It is the open source software used to create the language programming in order to run the system. Therefore, make this microcontroller suitable for industrial control as compare to other microcontroller.

4) Zigbee tranceiver

Zigbee wireless protocol is a new wireless technology guided by IEEE 802.15.4 Personal Area Network standard. It is mainly designed for the wide range controlling applications and to replace the existing non-standard technologies. One of the main advantages of this Zigbee communication is that it provides a noise free communication, the amount of noise added in this type of communication is very less compared to the other wireless communications. In this project the Zigbee series 1 will be used to ensure the data read from the gas sensor are successfully transferred with the Zigbee receiver, where the Zigbee is program using X-CTU software.

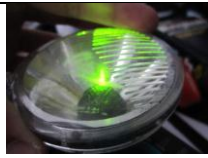



Fig. 3. The GUI of monitoring the gas leakage.

5) Modified Light indicator

A part from that, the LEDs has been modifying into a reflected light indicator as shown in Table III below. The reflected light indicator acts as visual alert signal for the users, so that inhalation of dangerous gas can be avoided.

TABLE III. THREE COLOURS OF LED TO INDICATE DIFFERENT CONDITIONS.

		
Condition I	Condition II	Condition III
Green LED indicates the condition of the room is in safety level.	Yellow LED shows that there is small amount of gas leakage in the room.	Red LED represents serious gas leakage occurs in the room.

C. Software approach

1) Graphical user interface

Fig. 3 represents the GUI of this model, which was developed by using LabVIEW. In this figure, the GUI shows three types of indicator lights as the different conditions, in terms of safety level, warning, and the dangerous level. The graph is used to display the gas concentration versus time in every minute and the sensor's voltage output waveform. Besides, there is voltmeter to show the voltage output from the gas sensor and the gas tank to indicate the concentration of leakage gas. Furthermore, the STOP button is used to stop the whole system during the emergency period. On the other hand, the Visa resource panel is used to indicate the VISA configuration, and data transfer interfacing between the Zigbee and LabVIEW, VISA configuration serial ports are required.

2) Flow chart

The Arduino function is to read the output data from the gas sensor with the help of ZigBee tranceiver. The VISA configuration com port is set in order to interface between the hardware and the software part. Then based on the threshold value was set, the sensor will keep sensing the gas concentration, and trigger the external output system as shown in Fig. 4.

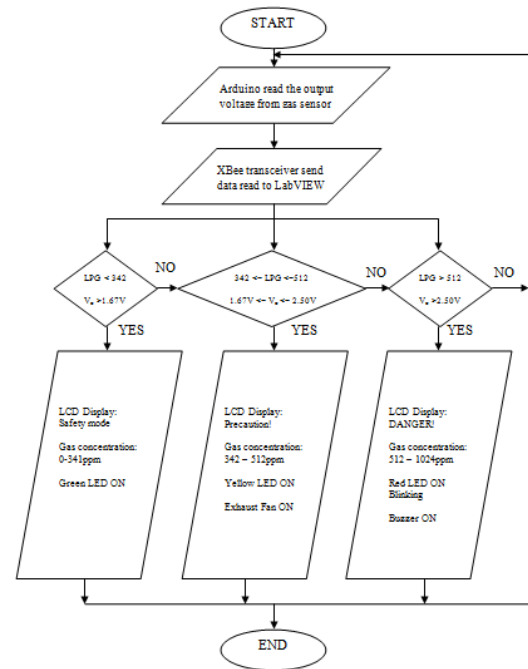

Fig. 4. Flow Chart for the Arduino Programming for MQ9.

III. RESULT AND ANALYSIS

For this model, the sensor is designed to place near to the gas pipeline in order to detect the leakage of gas. Thus, the response of the gas leakage detection can be obtained immediately and managed to obtain data from a scene of accident and display it in the monitoring system.

A. Result on Zigbee module Receive Signal Strength Test

This model using ZigBee technology guided by IEEE 802.15.4 Personal Area Network standard. The Signal

strength of Xbee Series 1 is tested by using USB to UART converter connected to it and test based on two conditions, which are between the indoor of the building, and the outdoor.

Based on the graph obtained in Fig. 5 shows the graph of RSSI value versus the distance, it is to test the signal strength of the Zigbee used in this system. The longest detect range for the XBee is up to 9.77meter, the captured RSSI value is -86dBm. The longer the distance the weaker is the signal strength. Besides, there is some noise interference from the wi-fi of the building which will affect the signal strength as well. In Table IV shows the actual value obtained from the X-CTU software on testing the signal strength for Zigbee module.

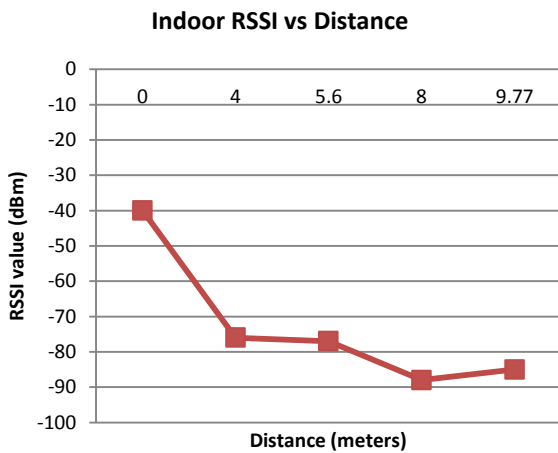

Fig. 5. Graph on receive signal strength indicator of Zigbee module in decibel-milliwatt(dBm) versus distance from indoor of one room to another.

TABLE IV. INDOOR DISTANCE AND READING OF RSSI FOR ZIGBEE MODULE.

Distance (meters)	RSSI (dBm)
0	-40
4	-76
5.6	-77
8	-88
9.77	-85

Fig. 6 depicts the longest detect range for outdoor which can detect range up to 100meter, and the captured RSSI value is -89dBm, but there are some bad signal received. Thus, the best distance is within 0 to 70m, which the signal consider stable.

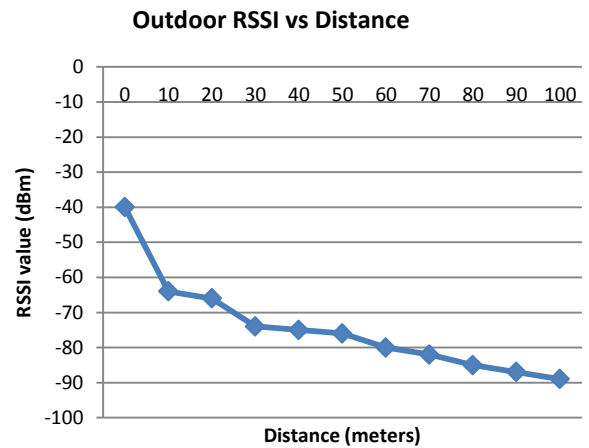

Fig. 6. Graph on receive signal strength indicator of Zigbee module versus distance outdoor of the building.

TABLE V. INDOOR DISTANCE AND READING OF RSSI FOR ZIGBEE MODULE

Distance (meters)	RSSI (dBm)
0	-40
10	-64
20	-66
30	-74
40	-75
50	-76
60	-80
70	-82
80	-85
90	-87
100	-89

Based on the results in Table V, in order to improve this monitoring system, this results can be use to compare with the future advanced technology for the improvement based on their receive signal strength. As for the value of RSSI between -40dBm to -76dBm is considered strong and stable in signal strength.

B. Graph Analysis

The graph in fig. 7 illustrates the data monitoring of the gas concentration in parts per million versus time which created by Microsoft Excel from the LabVIEW built-in export function. Based on the graph shows there is a leakage of gas when the gas concentration increases. The effect of actuation from the exhaust fan causes the gas concentration decreasing immediately as the precaution step to avoid condition becoming worst. The gas concentration is increases as the gas leakage is getting serious, and it reaches the threshold value of dangerous condition, therefore the system will send alarm signal to alert the users. Besides, users are able to track the condition of the room in real time and the all the reading is recorded as a back-up for maintenance checkup purpose.

Detection of Gas Leakage

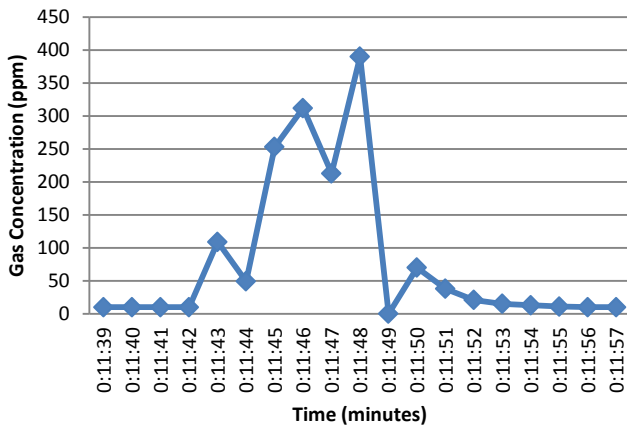

Fig. 7. Graph of gas leakage detection.

Detection of Gas Leakage in Dangerous Condition

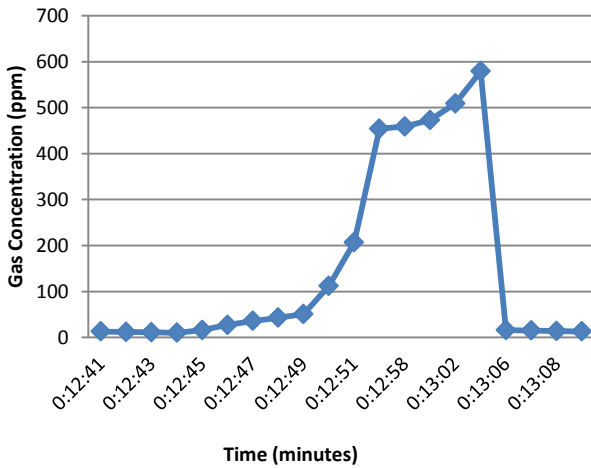

Fig. 8. Graph of gas leakage detection in serious condition.

The above graph Fig. 8 shows the leakage of gas concentration reaches the threshold value of dangerous condition, which exceed 512ppm therefore the system will send alarm signal to alert the users.

C. Results on GUI

Fig. 9, Fig. 10 and Fig.11 present the gas leakage monitoring system during safety, precaution, and dangerous condition respectively. The model was tested by using LPG, the increasing value of gas concentration and voltage output shows there is present of gas detected.. Based on the GUI, there are voltmeter and gas tank provided, to ease user’s to observe the level of gas leak.

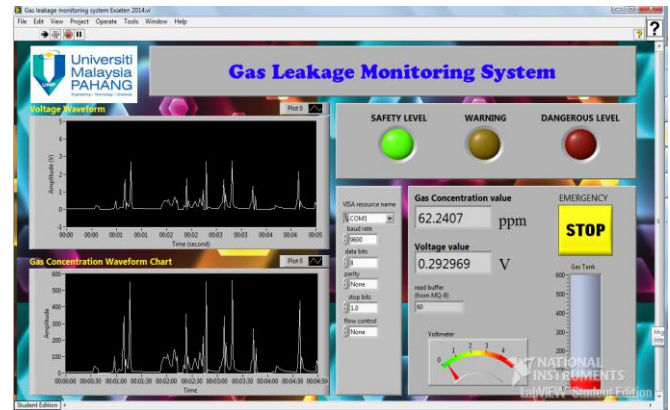

Fig. 9. Gas leakage monitoring system shows the room in the safe condition.

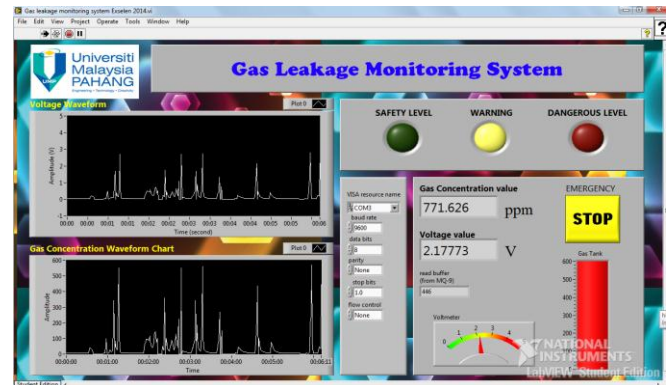

Fig. 10. Gas leakage monitoring system shows the room in the warning condition.

When there is small amount of gas leakage detected, the exhaust fan is triggered to ventilate the gases out from the room.

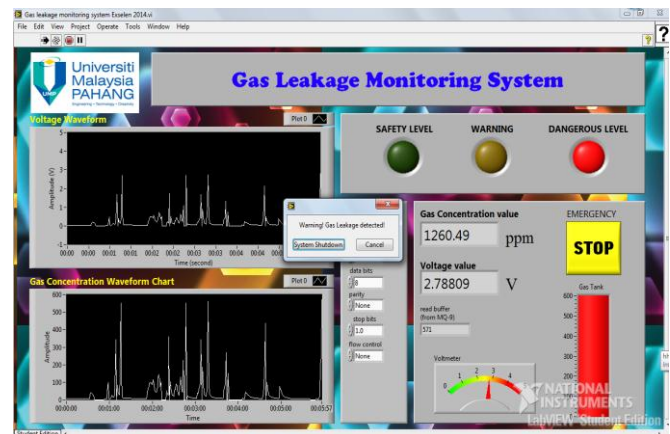

Fig. 11. Gas leakage monitoring system shows the room in the dangerous condition.

When there are large amount of gases leak is detected, the alarm signal will triggered to alert to users. At the same time in the monitoring part, will inform the user upon leakage and asked for immediate action.

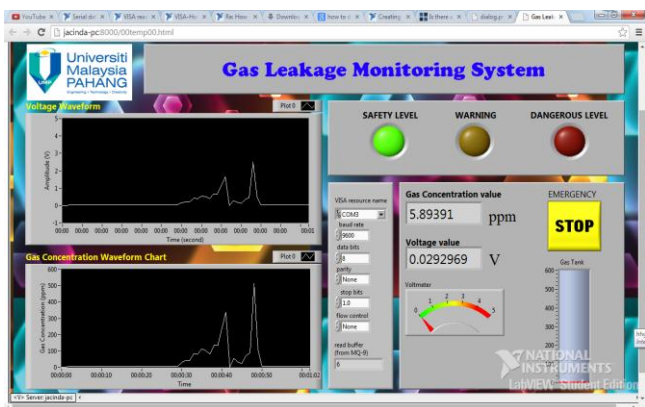

Fig. 12. Online monitoring the gas leakage system.

In order to monitor the gas leakage via internet, the client computer must have installed the LabVIEW run-time engine for viewing and controlling through the monitoring system as shown in Fig.12.

Next, the overall model functioning was controlled and interfaced with the LabVIEW software with the set up of block diagram as shown in Fig. 13. The VISA resources name is set to specified setting and the baud rate of this model is set to 9600 from the Arduino and Zigbee.

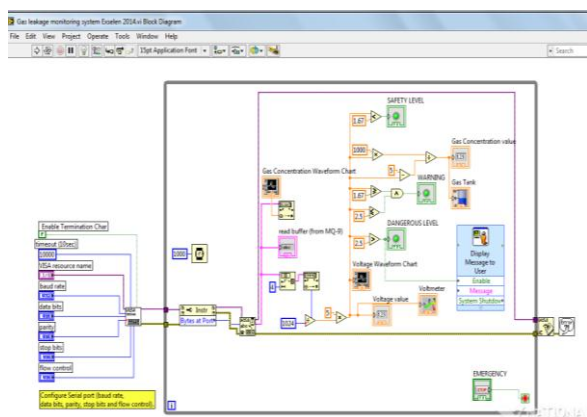

Fig. 13. Programming using block diagram in Labview software.



Fig. 14. Overall model configuration of the wireless gas leakage monitoring system with the gas detector.

In Fig. 14 represents the packaging of the model for the gas leakage monitoring system which are able to preview from the PC to check the condition of the room and the portable gas detector to detect to presence of gas leakage.

IV. CONCLUSION

As a conclusion, this gas leakage monitoring system by using Arduino and Zigbee was successfully developed and works well. There are various type of project using the same wireless concept in different field of application but in this system consists of many features compared to other projects, such as the monitoring system developed by using LabVIEW GUI, Zigbee transceiver used to monitor the gas concentration, gas detector with LCD display, alarm system built by using buzzer to alert the workers, and in the autonomous control system used to trigger the exhaust fan automatically in order to ventilate the dangerous gases in the room as well as auto shut down the main power and the gas supply within 10 minutes upon the leakage occurs to prevent the condition getting serious. Last but not least, this system was built for the purpose of life-saving that many people in a wide range of industries rely on to alert them to an explosive or hazardous atmosphere and prevent any disaster happen.

ACKNOWLEDGMENT

The authors would like to thank for the supports from Universiti Malaysia Pahang under the project RDU 110315, and Research and innovation Department of Universiti Malaysia Pahang for providing financial support.

REFERENCES

- [1] Infrared thermal imaging gas leak detection, Retrieved from: http://www.applied-infrared.com.au/?page_id=1562.
- [2] Zulaika, "Wireless Gas Monitoring System of Gas Detector", Degree dissertation, Faculty of Electrical Engineering (Medical Electronics), Universiti Teknologi Malaysia, Skudai, 2012.
- [3] M.F. Jan, Q. Habib, M. Irfan, M.Murad, K.M. Yahya, and G.M. Hassan, "Carbon Monoxide Detection and Autonomous Countermeasure System for a Steel Mill using Wireless Sensor and Actuator Network", IEEE 6th International Conference on Emerging Technologies, 2010.
- [4] J.Ding, J.Wang, N.Yuan, and Q.Pan, "The Monitoring System of Leakage Accidents in Crude Oil Pipeline based on Zigbee Technology", IEEE Changzhou University, 2011.
- [5] Rakesh, M., Dagadi, S., "Implementation of Wireless GasLeakage Detection System", Proceedings of the International Conference on Sensing Technology, ICST, art. no. 6461747 , pp. 583-588.2012.
- [6] H.Yang, Y.Qin, G.Feng, and H.Ci, "Online Monitoring of Geological CO2 Storage and Leakage Based on Wireless Sensor Networks.", IEEE BEE Sensors Journal, 2013.
- [7] G.A.A. Kumar, K.Rajasekhar, B.V.V.Satyanarayana, and K.S.Murthy, "Implementation of Real time Detection of Gas leakage in Industries using ARM7 and Zigbee", IEEE International Journal of Engineering Research & Technology, 2012.
- [8] V.Boonsawat, J.Ekchamanonta, K.Bumrunghet and S.Kittipiyakul, "XBee Wireless Sensor Networks for Temperature Monitoring", School of Information, Computer, and Communication Technology, 2010.
- [9] A.Shrivastava, R.Prabhaker, R.Kumar and R.Verma, "GSM Based Gas Leakage Detecton System", International Journal of Emerging Trends in Electrical and Electronics (IJETEE-ISSN: 2320-9569), Vol.3, Issue. 2, May, 2013.
- [10] Technical Data for MQ-9 gas sensor, HANWEI ELECTRONICS.CO.,LTD. Retrieved from: <http://www.particle-sensor.com/immagini/MQ-9.pdf>