



# Microcontroller-based Artificial Lighting to Help Growth the Seedling Pakcoy

Mas Aly Afandi, Irmayatul Hikmah, Chandra Agustinah

Fakultas Teknik Telekomunikasi dan Elektro Institut Teknologi Telkom Purwokerto, 128 D.I Panjaitan Street, Purwokerto, 53147, Indonesia

### ARTICLE INFORMATION

Received: September 11, 2021  
Revised: November 16, 2021  
Available online: November 30, 2021

### KEYWORDS

Agriculture, Artificial Lighting, Technology, Cultivation

### CORRESPONDENCE

Phone: +62 82228731141  
E-mail: [aly@ittelkom-pwt.ac.id](mailto:aly@ittelkom-pwt.ac.id)

### ABSTRACT

Improving efficiency and quality in farming activities is important reason of developing technology to support agriculture. Technology in agriculture such as image processing, Internet of Things (IoT), Artificial Intelligence, Big Data, and Artificial Lighting gives increasing trends. Artificial lighting technology has high impact to support agriculture in an area that has low sun light intensity such as in rainy season. Farmer has a difficulty to cultivating plant especially in early stage in rainy season. This problem happen because of the intensity of sun light is very minimum. Artificial lighting is a technology to solve early stage cultivating problem in rainy season. This technology can support agriculture for cultivating plant with minimum sun light. Artificial lighting contains light emitting diode (LED) that is laid out as an array. This research goal is to make an artificial lighting prototype to support early stage cultivating. Pakcoy is a plant that used to observe artificial lighting impact for early stage Pakcoy cultivation. This research shows Pakcoy plant placed in the prototype gives significant growth compared with a plant which placed in low light room. Pakcoy plant in artificial lighting gives 2 – 4 leaves, the height is 1.5 – 5cm, and from 18 seeds 10 is grow. This research can conclude that artificial lighting prototype can support early stage Pakcoy cultivation.

### INTRODUCTION

Smart farming is concept of improvement farming process through technology. Many farming problems can be solve using technology such as Internet of Things (IoT), modern control, Wireless Sensor Networks (WSN), machine learning, and artificial lighting. In a survey about role IoT technology in agriculture for implementing smart farming concept shows that IoT provides reliable solution. Implementation of IoT can improve modernizing of several domain in agriculture such as monitoring agricultural farms, automatically maintain plant, and monitoring pant cultivation parameter. IoT in smart farming allow many devices integrated into one server and the output of the device can be seen by using smartphone [1]. Smart farming concept that contains IoT technology such as monitoring humidity in paddy bags trough IoT platform. This research solves the measuring humidity problem in paddy bags by using IoT technology without break the paddy bags [2]. IoT also solve problem in smart precision farming in rural areas. Problem in rural area comes from monitoring irrigation in farm, fertilizer usage control, monitoring soil quality, and monitoring water quality in farm [3]. Not only outdoor farming, IoT also become solution for green house farming. IoT can be implemented to monitoring crop growth, monitoring crop harvesting, and climate control in greenhouse [4]. Smart device needs a power supply to operate. Research about green energy to support IoT for next generation smart farming also shows good concept [5]. Smart farming concept also comes with several issue such as security and privacy. Security and privacy in can becomes challenges and

opportunities for researchers to develop good communication protocol for smart device [6]. Communication technology in smart device also shows improvement. Low Power Wide Area Network (LPWAN) is a uptrends topic for remote communication in IoT technology [7]. Another technology that can be improve farming process is smart control. Fuzzy logic as a smart control to automated irrigation system also part of smart farming [8]. Next technology in smart farming is Artificial Intelligence (AI). Research about implementing AI indicate uptrends in 2016 to 2019 [9]. Artificial intelligence concept can be implemented to optimize automated irrigation system in smart farming [10].

With so many improvements in smart farming the most suitable technology to improve agriculture in Indonesia is artificial lighting. Light is the most important factor for cultivating plant [11]. All plant such as paddy, Pakcoy, lettuce, and spinach need light to growth. Artificial lighting is a technology to produce specific light spectrum for cultivating plant [12]. Many researches about implementation of artificial lighting have been done such as automatic control LED for plant growth [13], optimizing light spectrum for growing plant in indoor room [14], and light spectrum impact for Okra vegetables for germination and seedling. According to state of the art, research about artificial lighting shows increasing trends. Artificial lighting not only can implement in medium stage in cultivating plant but also in seedling stage. Artificial lighting is especially useful in countries where there is less farmland over the years.

This research is aim to make a prototype device for Pakcoy in seedling stage. The prototype will be implemented artificial lighting technology to fulfill light needed in early stage Pakcoy

plant cultivation. Data retrieval will be comparing 2 seedling processes in different environment. The first seedling model is planting Packoy in low light room and the other is using artificial lighting. Different environments seedling is needed to take a look the impact of artificial lighting according to two circumstances. Artificial lighting contains of 6 RGB LED to produce different light spectrum in the device.

**METHOD**

Light is essential needed for plant to drive photosynthesis. Light also an important external source that affects plant growth and cultivation. Photosynthesis proses needs light as an external energy and chlorophylls as an internal resource [15]. Chlorophylls is pigments that contain in leaf. Chlorophyll molecules absorb blue and red light. Blue and red wavebands is needed for plant to support cultivation efficiently [16].

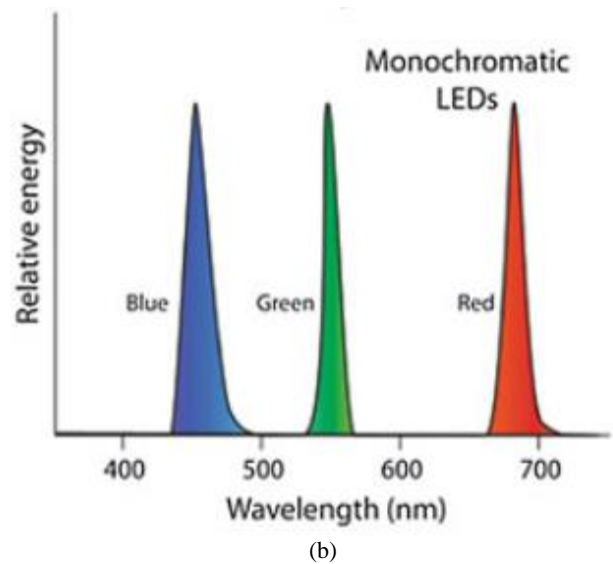

Figure 2. (a) Light Spectrum Fluorescent lamp (b) and Monochromatic LEDs [18].

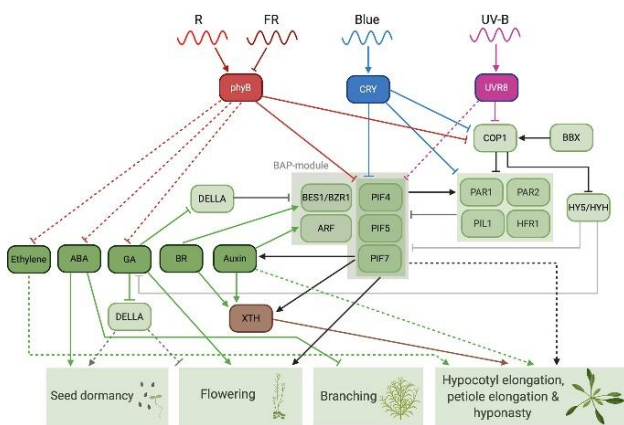
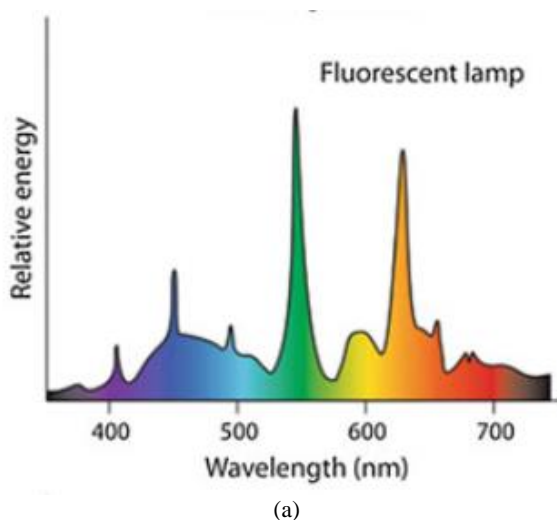

Figure 1. Overview of the Signal Transduction Pathways [17].

Figure 1 shows that plants absorb and reflect specific light spectral. Plant will absorb blue (400 – 500nm) and red (635 – 700nm) wavelength for photosynthesis process meanwhile reflecting Far Red (FR) wavelength (700 – 780nm). According from this research an artificial lighting especially in light source must be contain proper light wavelength, proper light intensity, and produce good light quality. Different light source will be produced different light quality.



Light quality comes by forming material in light source. Different light source will produce mixed wavelength and have an impact in producing light quality. Figure 2 (a) shows that light wavelength produces from fluorescent lamp contain another wavelength. Fluorescent lamp gives good light intensity but comes with many light spectrums. It can be affected plant photosynthesis process especially in seedling cultivation. The other light source is monochromatic LED from Figure (b). This light source produces one of color with more specific wavelength compared with fluorescent lamp. The other parameter for light source is power consumption. Fluorescent lamp power consumption is 5 – 125 Watt meanwhile LED power consumption is 0,1 – 5 Watt. Life span for fluorescent lamp approximately is 1000 Hours and LED lamp is approximately more than 50.000 Hours. Low power, specific wavelength, and longer life span are the advantage of LED as a light source to build artificial lighting device.

LED as an artificial lighting main device give promising result. LED Research to the use of LEDs for greenhouse, horticulture, and indoor plant give satisfied result. LED can fulfill the needs of plant for photosynthesis and cultivation in medium scale. In some research, combination of LEDs color has an effect to lettuce growth. LED with good quality and right spectrum will supports plants to grow [19]. LED also widely become a solution for sustainable solution for increasing agricultural production. Other research shows that spectrum in LED can increase nutrition absorption for plant. LED can become a tool to improve growth and nutritional value for various plant. LED combination spectrum red and blue color in LED enhanced macro and micro nutrient absorption in plant [20]. This study goal is to investigate the reaction of red and blue led to early stage of farming. The LED type that used in this research is different from common LED but give same spectrum as a monochromatic LED. This kind of LED needs control variable to get the specific spectrum that want to produce. By using this LED, the artificial lighting device can be more adjustable and adaptable to various environment especially for early stage of farming. Because in early stage of farming.

Artificial lighting prototype that developed in this research consist of Red Green Blue Light Emitting Diode as known as RGB LED, microcontroller, spectrum sensor, and plant cultivating container. RGB LED arranged as an array that consist of 3 RGB LED for each array and this prototype has 2 arrays. NODEMCU ESP32 is used as a microcontroller to control RGB LED trough Pulse Width Modulation (PWM) according to the output of spectrum sensor. AS7262 is a spectrum sensor for measure the light spectrum from RGB LED arrays. This sensor communicates with the microcontroller using I2C.

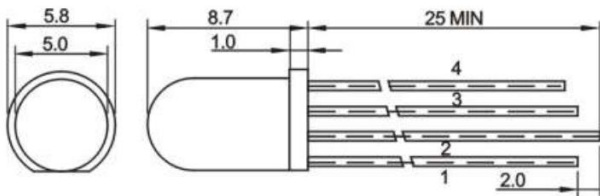

Figure 3. Red Green Blue Light Emitting Diode (RGB LED) [21].

RGB LED is a kind of light emitting diode that consist of 3 kind color spectrum that is Red, Green, and Blue to generate color shown in Figure 3. The color produce by this LED is combination from red, green and blue. According to Figure1. this LED has 4 connections. The configuration is connection 1 is trigger red color, connection 2 common cathode or common anode based on fabrication, connection 3 trigger blue color, and the last connection 4 trigger Green Color. This research needs a light source where the light color can be customized according to the environment. This kind of LED use 5V as an anode source and use pulse width modulation (PWM) to drive and produce specific light

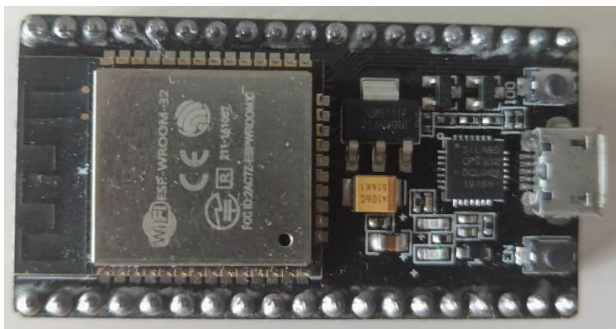

Figure 4. NODEMCU ESP32.

Figure 4 shows a NODEMCU ESP32 as a main controller for the prototype. This controller is the most important component for artificial lighting device in this research. This component role is receiving sensor reading and control the intensity of RGB LED. This microcontroller has 34 programmable GPIOs, 12-bit SAR ADC and up to 18 channels ADC, 2 pin DAC with 8-bit resolution, PWM channel up to 16 pins, also support I2C, I2S, SPI and UART communications [22]. Specifications of this microcontroller is suitable to use in prototyping artificial lighting device because the prototype needs PWM and I2C. PWM is needed to drive light from RGB LED and I2C is needed to

communicate with several sensor such as light spectrum sensor for artificial lighting.



Figure 5. Light Spectrum Sensor AS7262.

Figure 5 shows light spectrum sensor AS7262 that used to make the artificial lighting prototype. This sensor has a role to read light spectrum from RGB LED and send the information to NODEMCU ESP32. Knowing the light spectrum is an important task. To create good environment for cultivating and produce the right light spectrum for plant, irradiation spectrum sensor is needed. Output from this sensor can become an important variable for microcontroller to calculate control value. Control value will affect PWM and PWM will affect the intensity and light quality from RGB LED. It can be very useful to develop artificial lighting for early stage of farming.

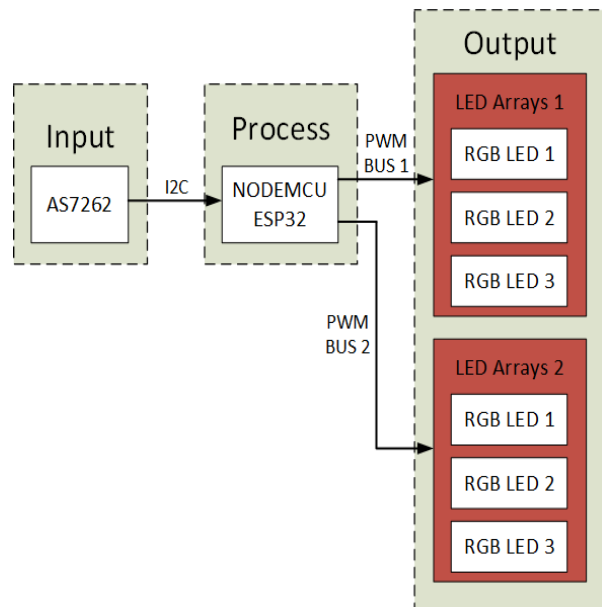

Figure 6. Hardware Block Diagram.

Figure 6 shows role of all the component that used in this research in one system. Hardware input comes from AS7262 spectrum sensor. This sensor will generate spectrum according to the light from RGB LED. This sensor communicates with NODEMCU

ESP32 as probes device using I2C communications. NODEMCU ESP32 will get spectrum color reading, generate control value, and make the control value affect the Pulse Width Modulation (PWM) to adjust RGB LED color spectrum. NODEMCU ESP32 adjust RGB LED color using PWM bus because RGB LED need more than one PWM signal. One PWM bus consist of 3 PWM signal for each color in RGB LED respectively. In one PWM bus needs 3 signals because of each RGB LED in one array consist of 3 connections. Connection red, connection green, and connection blue. PWM signals use parallel connection for each RGB LED in one array to operate. To make sure light needs for seed are met, this prototype uses 2 arrays that represent 2 spectrums, red spectrum and blue spectrum. In one LED array consist of 3 RGB LED to make one light spectrum. This configuration is needed to produce a good quality of light.

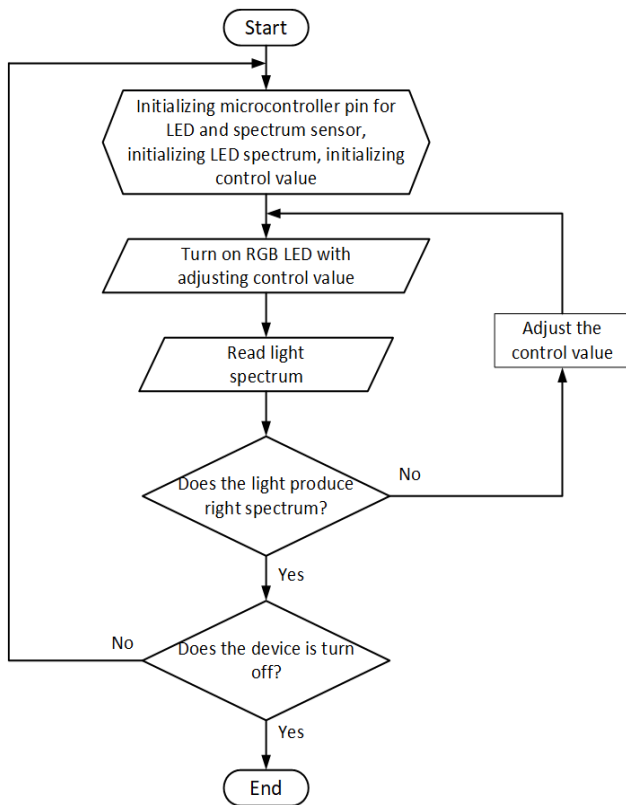

Figure 7. Software Flowchart.

Figure 7 shows software flowchart for developing artificial lighting. This software flowchart is a program flow that embed in NODEMCU ESP32. NODEMCU ESP32 need to be configure the used pin first. This research config GPIO5, GPIO17, and GPIO16 as PWM bus 1. GPIO4, GPIO2, and GPIO15 as a PWM bus 2. GPIO 22 and GPIO 21 config as I2C communication with the AS7262 sensor. After the configuration is set up, NODEMCU ESP32 will send PWM value to PWM bus 1 and PWM bus 2. LED will turn on and gives light color as a programmed. AS7262 sensor will read light spectrum from LED Array 1 and LED Array 2. If the LED is not producing the light spectrum desired, NODEMCU ESP32 will adjust the control value to generated new PWM value for LED Array 1 and LED Array 2. If light produce the desired light spectrum, microcontroller will do a loop program until the system will turn off or the device is broken.



Figure 8. Preparation of Experiment

Figure 8 shows the first preparation experiment for gaining data from plant experiment with artificial lighting and without artificial lighting. This experiment needs a rockwool as a media of seedling. One container consists of 18 rockwool with 1 seed of Pakcoy in it. This experiment uses two container, one container is store with the artificial lighting in it and another is store in low sun light room. Experiment carried out for 7 days and monitored each day. Data retrieved during the monitoring period is number of leaves, plant height, how many seeds will grow, and the condition of plant. Monitoring for seven days according to the seeding period for Pakcoy plant for hydroponic farming method.

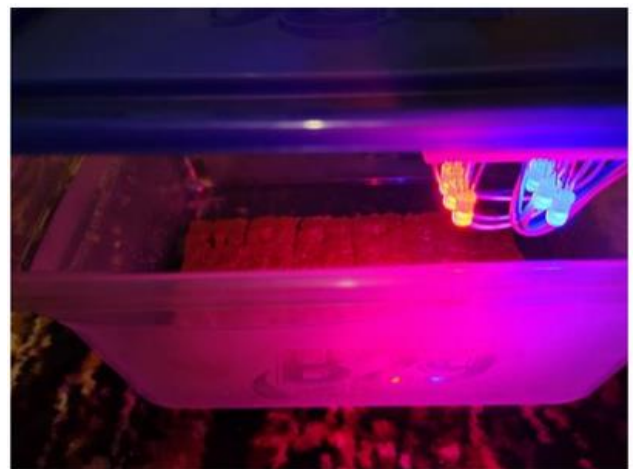

Figure 9. Seedling Container with Artificial Lighting.

Figure 9 shows the seedling container with artificial lighting in it. This container has a configuration to fulfils the other parameter such as air and water. The distance between LED and the seed is 5cm. Distance value comes from measuring the top container to rockwool. Container is not cover to make sure that air is circulate inside container seedling box. The other component which is water is gives for each seedling container respectively is carried out every day. With this configuration, the different from other container is the artificial lighting device. With these two configurations, the experiment can compare and measure the efficiency of artificial lighting for Pakcoy seedling process. Number of leaves, plant height, how many seeds will grow, and the condition of plant is observed every day.

## RESULTS AND DISCUSSION

The experiment data retrieval consists of PWM experiment, sensor AS7262 spectrum reading, and seeds monitoring. According data collection from the experimental process, it shows that the plant with artificial lighting container in provide better growth compared with low light container. PWM experiment is carried out to see the impact of PWM signal for RGB LED. This experiment also to make sure that RGB LED will change color while different PWM signal is gives. First Experiment will focus on impact of PWM signal for intensity of red, green and blue LED color.

Table 4.1. Effect PWM Signal Through RGB LED for Red Light

Light Intensity	PWM Red Channel	PWM Green Channel	PWM Blue Channel
Low	200	255	255
Medium	150	255	255
High	50	255	255

Table 4.2. Effect PWM Signal Through RGB LED for Green Light

Light Intensity	PWM Red Channel	PWM Green Channel	PWM Blue Channel
Low	255	200	255
Medium	255	150	255
High	255	50	255

Table 4.3. Effect PWM Signal Through RGB LED for Blue Light

Light Intensity	PWM Red Channel	PWM Green Channel	PWM Blue Channel
Low	255	255	200
Medium	255	255	150
High	255	255	50

Table 4.4. PWM Effect for Controlling Color Through RGB LED

Color	PWM Red Channel	PWM Green Channel	PWM Blue Channel
White	50	50	50
Yellow	50	50	255
Violet	50	255	50
Tosca	255	50	50
Red	50	255	255
Green	255	50	255
Blue	255	255	50

According to Table 4.1, 4.2, and 4.3 shows that PWM signal gives influence for light intensity. The lower PWM signal gives will stronger light intensity for each color. This phenomenon shows that RGB LED used in this experiment is common anode type. Table 4.4 shows that different combination signal gives different color. With the 3 basic color combination red, green, and blue can produce 5 different color light which is white, yellow, violet, and tosca. Different color means different light spectrum. Control value for PWM signal need to be maintain as good as possible to make sure that light spectrum in container is right.

AS7262 sensor experiment shows that color filter in this sensor is works properly. All 6 visible channel spectrum 450nm, 500nm, 550nm, 570nm, 600nm, and 650nm can be measured by this sensor. This experiment has been done with adjust ranged between light source and sensor. Sensor will measure basic color red, green and blue spectrum.

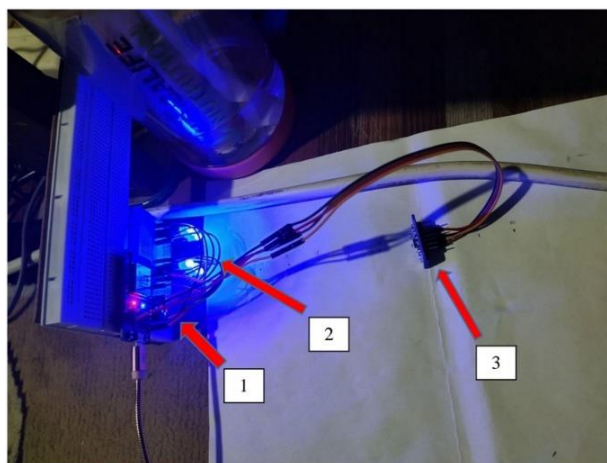

Figure 10. AS7262 Sensor Experiment Setup.

Figure 10 shows how AS7262 data retrieval setup. Figure mark with 1 is microcontroller, mark with 2 is light source, and mark with 3 is AS7262 sensor. Light source will produce the dominant basic light color which is red, green and blue. Measurement will be done with various distance parameter.

Table 4.5. AS7262 Irradiation Spectrum Sensor Output

Range	650nm Spectrum Filter ( $\mu\text{W}/\text{cm}^2$ )	550nm Spectrum Filter ( $\mu\text{W}/\text{cm}^2$ )	450nm Spectrum Filter ( $\mu\text{W}/\text{cm}^2$ )
2cm	50.21	48.97	44.89
4cm	43.66	35.54	30.12
6cm	24.28	16.75	21.98
8cm	14.71	11.56	20.37
10cm	12.83	9.98	13.87
12cm	10.35	6.76	10.01
14cm	9.01	4.43	7,26
16cm	7.75	3.21	6.11
18cm	6.13	2.51	4.27
20cm	3.37	1.88	3.35

Table 4.5 shows that AS7262 can sense irradiation in 650nm, 550nm, and 450nm. Light spectrum with 650nm represent by red color, 550nm spectrum represent green color, and 450nm spectrum represent by blue color. All the data from Table 4.5 is get by changing the light color through PWM. Range can affect light irradiation level. The far light source, the lower irradiation level can be measure. According to these results, the distance between seeds and artificial lighting device can be adjust into 5cm. If the distance is 2 or 4 cm will be to close and bother seeds growth.

Seeds monitoring data retrieval consists of seeds growth, seeds height, and number of leaves. This experiment will compare the container with artificial lighting and without it. This data collects after 7 days seedling process with 18 rockwools.

Table 4.6. Container with Artificial Lighting

Number Rockwool	Germinate	Seeds Height (cm)	Number of Leaves
R1	-	-	-
R2	-	-	-
R3	-	-	-
R4	√	4.5	4
R5	-	-	-
R6	√	4.5	4
R7	√	5.5	4
R8	√	1.5	2
R9	-	-	-
R10	√	2.5	3
R11	-	-	-
R12	√	2.5	3
R13	√	1.5	2
R14	-	-	-
R15	√	5	3
R16	√	4.5	3
R17	-	-	-
R18	√	5	3

Table 4.6 shows that 10 seeds germinate from total of 18 seeds. The range of plant height is 1.5 – 5cm and the range number of leaves is 2 – 4. Another seed seems doesn't germinate because of the quality of the seeds or something parameter in cultivating is not fulfill. This data proves that the seeds in container with artificial lighting have grown. This data will be compared with another container.

Table 4.7. Container without Artificial Lighting

Number Rockwool	Germinate	Seeds Height (cm)	Number of Leaves
R1	-	-	-
R2	-	-	-
R3	√	6	-
R4	√	6	-
R5	-	-	-
R6	-	-	-
R7	-	-	-
R8	√	8	-
R9	√	5	-
R10	√	3.5	-
R11	√	3	-
R12	√	4.5	-
R13	√	6.5	-
R14	-	-	-
R15	-	-	-
R16	-	-	-
R17	-	-	-
R18	-	-	-

Table 4.7 shows that 8 seeds germinate of total 18 seeds. The range of plant height is 3 – 8cm with no leaves. This data proves that the seeds in container without artificial lighting have grown but not as good as plant in container with artificial lighting. According from data in Table 4.6 and compare it with data from

Table 4.7 can be expect that a plant seedling with artificial lighting gives impact if compare with not using artificial lighting. Artificial lighting can be used to fulfill light needed in seedling process while rainy season.



Figure 11. Seeds Germination in Container with Artificial Lighting.

Figure 11 shows a seeds condition in container with artificial lighting in it. The seeds grow with green leaves and strong stem. Early-stage seedling for Pakcoy plant using artificial lighting have been done in this experiment. According to the Table. 4.6 and Figure 11, the purpose of this research is beginning to appear. Artificial lighting gives good impact for Pakcoy plant. Number of leaves and plant height prove it.



Figure 12. Seeds Germination in Container without Artificial Lighting.

Figure 12 shows a seeds condition in container without artificial lighting. Figure 12 is cultivating condition from Table 4.7The seeds grow with no leaves and etiolation. This condition will cause failure in the nursery process.

### CONCLUSIONS

According to the data retrieval from this research shows that artificial lighting gives good impact for seedling process plant. The plant with artificial lighting provides good growth compared to low light environments. Low light environment cause etiolation when plant with artificial lighting not. Artificial lighting cause leaf formation to Pakcoy plant. The range number of leaves from this research is 2 – 4 leaves. This research conclude that artificial lighting can improve seedling process in rainy season with low light.

## ACKNOWLEDGMENT

This work was funded by Direktorat Sumber Daya RISTEKBRIN through Penelitian Dosen Pemula scheme and also supported by LPPM and Faculty of Telecommunication and Electrical Engineering of Institut Teknologi Telkom Purwokerto.

## REFERENCES

- [1] M. S. Farooq, S. Riaz, A. Abid, K. Abid, and M. A. Naeem, "A Survey on the Role of IoT in Agriculture for the Implementation of Smart Farming," *IEEE Access*, vol. 7, pp. 156237–156271, 2019.
- [2] P. Serikul, N. Nakpong, and N. Nakjuatong, "Smart Farm Monitoring via the Blynk IoT Platform: Case Study: Humidity Monitoring and Data Recording," in *2018 16th International Conference on ICT and Knowledge Engineering (ICT&KE)*, 2018, pp. 1–6.
- [3] N. Ahmed, D. De, and I. Hussain, "Internet of Things (IoT) for Smart Precision Agriculture and Farming in Rural Areas," *IEEE Internet Things J.*, vol. 5, no. 6, pp. 4890–4899, 2018.
- [4] R. Rayhana, G. Xiao, and Z. Liu, "Internet of Things Empowered Smart Greenhouse Farming," *IEEE J. Radio Freq. Identif.*, vol. 4, no. 3, pp. 195–211, 2020.
- [5] K. Huang *et al.*, "Photovoltaic Agricultural Internet of Things Towards Realizing the Next Generation of Smart Farming," *IEEE Access*, vol. 8, pp. 76300–76312, 2020.
- [6] M. Gupta, M. Abdelsalam, S. Khorsandroo, and S. Mittal, "Security and Privacy in Smart Farming: Challenges and Opportunities," *IEEE Access*, vol. 8, pp. 34564–34584, 2020.
- [7] N. Islam, B. Ray, and F. Pasandideh, "IoT Based Smart Farming: Are the LPWAN Technologies Suitable for Remote Communication?," in *2020 IEEE International Conference on Smart Internet of Things (SmartIoT)*, 2020, pp. 270–276.
- [8] J. R. Dela Cruz, J. V. Magsumbol, E. P. Dadios, R. G. Baldovino, F. B. Culibrina, and L. A. G. Lim, "Design of a fuzzy-based automated organic irrigation system for smart farm," in *2017 IEEE 9th International Conference on Humanoid, Nanotechnology, Information Technology, Communication and Control, Environment and Management (HNICEM)*, 2017, pp. 1–6.
- [9] Z. Ünal, "Smart Farming Becomes Even Smarter With Deep Learning—A Bibliographical Analysis," *IEEE Access*, vol. 8, pp. 105587–105609, 2020.
- [10] J. R. dela Cruz, R. G. Baldovino, A. A. Bandala, and E. P. Dadios, "Water usage optimization of Smart Farm Automated Irrigation System using artificial neural network," in *2017 5th International Conference on Information and Communication Technology (ICoICT)*, 2017, pp. 1–5.
- [11] A. Zakurin, A. Shchennikova, and A. Kamionskaya, "Artificial-Light Culture in Protected Ground Plant Growing: Photosynthesis, Photomorphogenesis, and Prospects of LED Application," *Russ. J. Plant Physiol.*, vol. 67, pp. 413–424, May 2020.
- [12] S. Dutta Gupta and A. Agarwal, "Artificial Lighting System for Plant Growth and Development: Chronological Advancement, Working Principles, and Comparative Assessment," in *Light Emitting Diodes for Agriculture: Smart Lighting*, 2017, pp. 1–25.
- [13] P. Limprasitwong and C. Thongchaisuratkrul, "Plant Growth Using Automatic Control System under LED, Grow, and Natural Light," in *2018 5th International Conference on Advanced Informatics: Concept Theory and Applications (ICAICTA)*, 2018, pp. 192–195.
- [14] L. Marcos and K. Mai, *Light Spectra Optimization in Indoor Plant Growth for Internet of Things*. 2020.
- [15] B. F. Degni, C. T. Haba, W. G. Dibi, Y. A. Gbogbo, and N. U. Niangoran, "Impact of light spectrum and photosynthetic photon flux density on the germination and seedling emergence of Okra," *Light. Res. Technol.*, vol. 52, no. 5, pp. 595–606, Dec. 2019.
- [16] Y. Zhang, E. Kaiser, Y. Zhang, Q. Yang, and T. Li, "Red/blue light ratio strongly affects steady-state photosynthesis, but hardly affects photosynthetic induction in tomato (*Solanum lycopersicum*)," *Physiol. Plant.*, vol. 167, no. 2, pp. 144–158, Oct. 2019.
- [17] M. Huber, N. M. Nieuwendijk, C. K. Pantazopoulou, and R. Pierik, "Light signalling shapes plant–plant interactions in dense canopies," *Plant. Cell Environ.*, vol. 44, no. 4, pp. 1014–1029, Apr. 2021.
- [18] T. Hytönen *et al.*, "Effects of LED light spectra on lettuce growth and nutritional composition," *Light. Res. Technol.*, vol. 50, no. 6, pp. 880–893, Mar. 2017.
- [19] P. Pinho, K. Jokinen, and L. Halonen, "The influence of the LED light spectrum on the growth and nutrient uptake of hydroponically grown lettuce," *Light. Res. Technol.*, vol. 49, no. 7, pp. 866–881, Apr. 2016.
- [20] Y. Allahverdiyeva *et al.*, "Integration of photosynthesis, development and stress as an opportunity for plant biology," *New Phytol.*, vol. 208, no. 3, pp. 647–655, Nov. 2015.
- [21] K. Ltd, "5mm RGB LED Common Cathode TECHNOLOGY DATA SHEET & SPECIFICATIONS Device." .
- [22] E. Systems, "ESP32 Series Datasheets." 2021.

## AUTHOR(S) BIOGRAPHY

### Mas Aly Afandi

Mas Aly Afandi currently is a Lecturer at Telecommunication Engineering Department of Institut Teknologi Telkom Purwokerto, Central Java. He finished Master degree study at Eletrical department of Institut Teknologi Sepuluh Nopember, Surabaya, East Java in 2019.

### Irmayatul Hikmah.

Irmayatul Hikmah currently is a Lecturer at Biomedical Engineering Department of Institut Teknologi Telkom Purwokerto, Central Java. She finished Master degree study at Physics department of Institut Teknologi Sepuluh Nopember, Surabaya, East Java in 2019.

### Chandra Agustinah

Chandra Agustinah is a student at Telecommunication Engineering Department of Institut Teknologi Tekom Purwokerto.