

CO Pollution Warning System for Indoor Parking Area Using FPGA

Prima Dewi Purnamasari, Evan G. Sumbayak, Vicky D. Kurniawan, RR. Wulan Apriliyanti

Departement of Electrical Engineering, Universitas Indonesia

Article Info

Article history:

Received Jan 22, 2013

Revised May 19, 2013

Accepted Jun 4, 2013

Keyword:

Carbon Monoxide
Pollution
Warning System
Indoor Parking Area
FPGA

ABSTRACT

From some compounds used as parameters in air pollution-such as O₃, Particulate Materials, CO, NO₂, SO₂ and Pb-CO is the most common cause of poisoning accidents. Indoor parking area is one sample of potential area for CO pollution. However, according to the scientific nature of CO-tasteless, colorless, and odorless-people exposed to CO are usually not aware that s/he exposed to dangerous levels of CO. This research aimed to make a prototype of an embedded system that can monitor air pollution, give an effective warning and it should be affordable. The prototype of CO air pollution alert system has been successfully built using FPGA Xilinx Spartan 3E as the major component. Sensor Hanwei MQ7 used in this prototype has been tested in a simulation box using cigarette smoke as CO pollutant and the reading result has met the characteristic curve in the datasheet. The system interface has met user satisfaction with MOS value 4.31 from 5 scales. Based on the response time testing, we conclude that FPGA is suitable to be used in a system that performs fast parallel processing based on logical actions from the input given.

Copyright © 2013 Institute of Advanced Engineering and Science.
All rights reserved.

Corresponding Author:

Prima Dewi Purnamasari,
Departement of Electrical Engineering, Faculty of Engineering,
Universitas Indonesia,
Kampus UI Depok 16424, West Java, Indonesia.
Email: prima.dp@ui.ac.id

1. INTRODUCTION

Every year, there are more than 400 people dead because of Carbon Monoxide (CO) poisoning accident in the USA [1]. While the specific statistical data has not been found, CO poisoning accident in Indonesia has been reported in some news portal such as in [2], [4]. The accident reported was always inside or around motor vehicles and most of the case were happened inside the motor vehicles that parked in the public parking area, indoor or outdoor. Based on the research by Hanna R. et al., parking area, which has highest CO concentration, is the covered parking area [5]. This proved that covered or indoor parking area needs pollution warning tool-especially CO-so that human inside is less possibility to suffered from pollution effect so that there will be no more pollution accident happened.

In Indonesia, air quality meter that can monitor particulate materials, O₃, SO₂, NO₂ and CO is already available [6]. However, such tool is not or has not been available in indoor public area. The absence of this tool in high-risk air pollution public spaces may be due to the high cost of such equipment [7].

Some commercial pollution meter tool like [8], [9] are not available in Indonesia. These commercial tool are also did not give warning to human. Researchers have also tried to made such automated pollution reporting tool such as in [10]-[12]. But again, these systems do not give report and warning to the people surrounds the pollution itsels who actually do not care about pollution. This research aims to make a system that can give a warning and report to the people using a display unit inside the indoor parking space. So that people are more aware to air pollution that threatened their health.

Some of the available tools utilizes microcontroller [10], or computer [11], [13], or sensor networks [13] to send the data from sensor to the processing unit. In this research we use FPGA as the main unit to receive data from sensor readings and give corresponding report and warning to human. FPGA was chosen because it can act as a primary logical unit that can perform simple calculations and activate the warning and reporting devices in accordance with the pollution conditions. Using FPGA, this system can become a compact, fast, and inexpensive embedded systems. FPGA was chosen over microcontroller because this system does not need complicated computation, while we expect faster process. We used Xilinx Spartan 3E FPGA which is the standard type of FPGA for academic purposes. Xilinx Spartan 3E board can be seen in Figure 1. FPGA can be programmed by VHDL on Xilinx Integrated Software Environment software (ISE). In this research we use Xilinx ISE Design Suite 13.2.

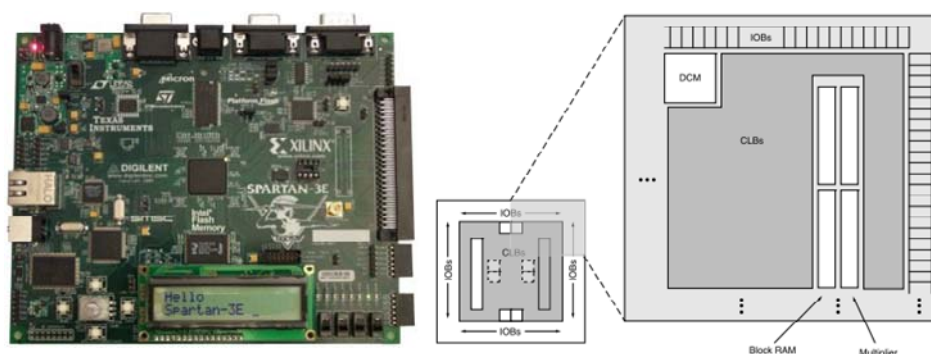

Figure 1. FPGA Spartan 3E (left) [14] and Its Architecture (right) [15]

From some compounds used as parameters in air pollution such as Ozone (O₃), Particulate Materials, Carbon Monoxide (CO), Nitrogen Oxide (NO₂) Sulfur Dioxide (SO₂) and Lead (Pb) [16], CO gas is the most common cause of poisoning accidents and even death [17]. This is happened because the hemoglobin (Hb) binding affinity for CO is 200 times greater than its affinity for Oxygen [18]. CO is a tasteless, colorless, and odorless gas. The most common symptoms of CO poisoning are headache, dizziness, limp, vomiting, chest pain and confusion [16]. CO poisoning in higher level can lead to loss of consciousness and even death. Except it has been suspected before, CO poisoning is very difficult to detect because the symptoms are very similar to other disease. In fact, human who was sleeping and CO poisoned may die before s/he felt the signs [16].

Table 1. Sign and Symptoms of Carbon Monoxide Exposure and Its Effects on Human [19]

PPM CO in Air	Percent CO in Air	Symptoms experienced by healthy adults	Comments
35 ppm	0.0035%	No effect in healthy adults	35 ppm is WISHA* 8-hour average permissible limit
100 ppm	0.01 %	Slight headache, fatigue, shortness of breath, errors in judgment	
200 ppm	0.02%	Headache, fatigue, nausea, dizziness	200 ppm is Short Term Exposure Limit (STEL)
400 ppm	0.04%	Severe headache, fatigue, nausea, dizziness, confusion, can be life-threatening after 3 hours of exposure	
800 ppm	0.08%	Headache, confusion, collapse, death if exposure is prolonged	
1500 ppm	0.15%	Headache, dizziness, nausea, convulsions, collapse, death within 1 hour	Levels greater than 1500 ppm are considered "immediately dangerous to life or health" (IDLH). This is the ceiling limit.
3000 ppm	0.3%	Death within 30 minutes	
6000 ppm	0.6%	Death within 10 – 15 minutes	
12,000 ppm	1.2%	Nearly instant death	

*Washington Industrial Safety and Health Act

The Washington Industrial Safety and Health Act (WISHA) gives the allowable limit for CO exposure is 35 ppm for 8-hour exposure period, and above the allowable limit is 200 ppm. Table 1 shown the

effects of CO on human health. Based on this table, in this research we set the borderline for safe condition is below or equal to 35ppm, and the borderline for dangerous level is above or equal to 200ppm.

However, according to the scientific nature of CO is tasteless, colorless, and odorless, humans are exposed to CO are usually not aware that he was exposed to dangerous levels of CO in. Studies conducted by Hanna R. et al showed that the level of awareness on the parking attendant in parking area is not influenced by the levels of CO area [5]. This is a picture that human vigilance of the dangers of CO exposure in the covered parking area is still very low. Therefore, in this pollution warning system we use CO sensor as the prototype.

2. RESEARCH METHOD

2.1. Requirement Analysis

This research aims to develop a prototype for pollution monitoring and warning system that can monitor the condition of the air pollution in covered parking area, can provide a warning system for humans around it effectively, and can provide a simple countermeasure to mitigate the effects of air pollution. The prototype system developed from this research can be utilized and implemented in areas such as covered/indoor parking available in the apartments, shops, hotels, and offices. It is expected that the results of this research can increase people's awareness of pollution occurred nearby.

- User can see CO level through the display in the form of graph and numbers for ppm level and 3 pollution conditions: safe ("AMAN"), alert ("WASPADA") and dangerous ("BAHAYA").
- System indicates the pollution condition through 3 colours of LED; green for safe, yellow for alert, and red for dangerous.
- System activate buzzer in dangerous pollution condition
- System activate fan in low speed in alert condition and high speed in dangerous condition.

The requirements above are functional requirements, where the non-functional requirement of the systems is:

- System has friendly user interface.

According Table 1, the specification for 3 pollution condition in this system, safe, alert and dangerous is define as follows:

- Safe condition: CO level \leq 35 ppm
- Alert condition: 35 ppm < CO level \leq 200 ppm
- Dangerous condition: CO level > 200 ppm

2.2. System Design

Based on the requirements, we divide the systems into 4 main blocks of components, which are:

- FPGA as the main components of the system. FPGA used in this monitoring system is Xilinx Spartan 3E Starter Edition (3S500E).
- Sensor as pollution detector component. Sensor used in this system is Hanwei MQ-7 CO sensor.
- Display used as the interface of the monitoring system to the user. Display used in the system prototype is LCD monitor 18 inch wide type.
- Warning system consists of 3 LEDs (green, yellow and red) to indicate 3 pollution condition, buzzer to indicate dangerous condition and fan to be activated to mitigate the CO level in the air.

The block diagram of hardware used in the system can be seen on

Figure 2.

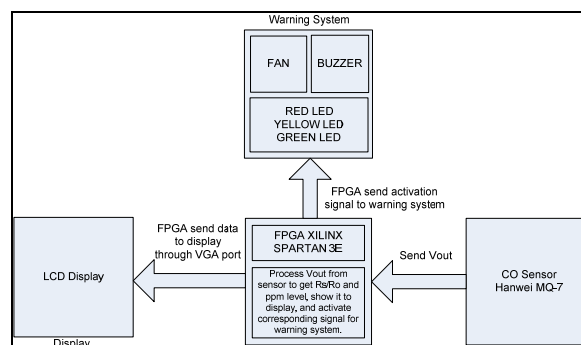

Figure 2. Block diagram of the monitoring system using FPGA

The flow of the system can be seen more clearly on the flowchart given in Figure 3. The interaction of each entity in the system can be seen on sequence diagram on Figure 4.

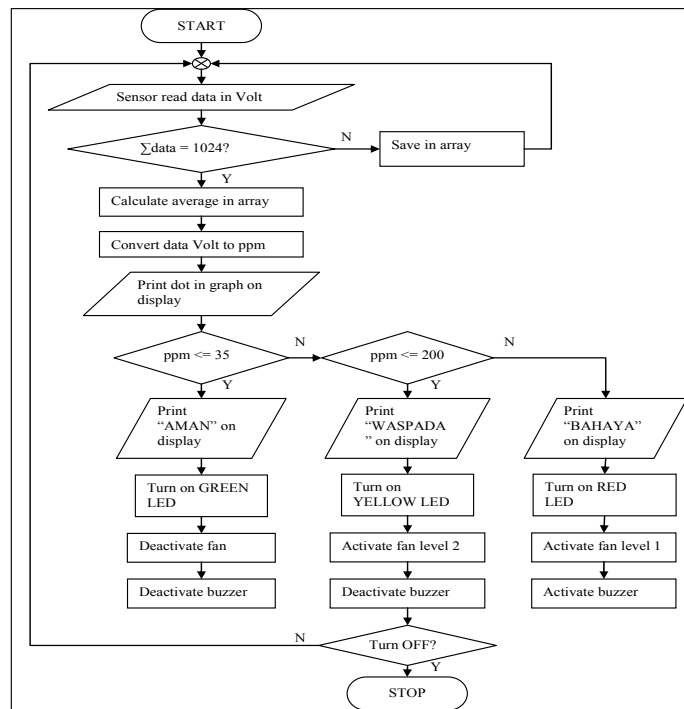

Figure 3. Flowchart of the system

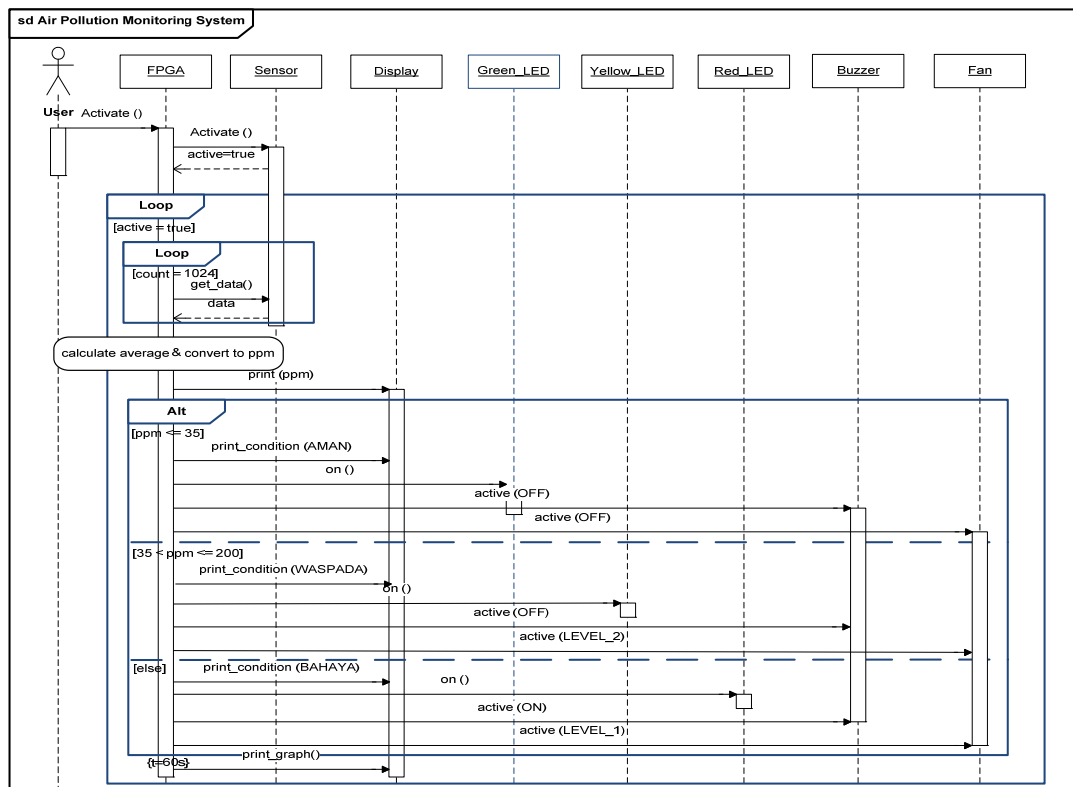

Figure 4. Sequence diagram of the system

2.3. Implementation

In system implementation to FPGA as the main unit, we use hybrid method to configure the FPGA, which is by using VHDL code and also using schematic diagram.

2.3.1. Sensor interfacing to FPGA

CO Gas Sensor Hanwei MQ-7 uses 2 heating voltage, 5V and 1.4 V, and performed during each 60 seconds and 90 seconds. To give alternating voltage 5V and 1.4 continuously, a circuit as shown in

Figure 5 is needed. The circuit was connected to the power supply on JP1. On JP2, pin 1 is the output to be connected to the sensor, pin 2 is ground, pin 3 is PWM regulated by the FPGA through 1 pin header on the expansion connector J4 (E8), and pin 4 is ground power supply.

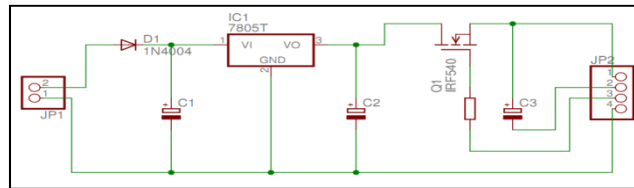

Figure 5. Sensor to FPGA interfacing circuit

VHDL program as can be seen in

Figure 6 is needed to control PWM so that it can give alternating voltage to the sensor. This is conducted using `pwm_accumulator` variable. If 1000 is equal to 5V, then 280 is equal to 1.4V. To control the voltage according to the duration needed, FPGA duty cycle should be changed. In the system, we use 50 MHz frequency. It means that in 1 second there will be 50,000,000 times of clock. The sensor needs 60 seconds and 90 seconds power cycle. Therefore, PWM needs `co_pwr_time` variable 50,000,000 and count variable 150, which is the sum of 60 s and 90 s for each phase.

```

Start
  port : clk, pwm_out, pwm_accumulator, co_pwr_time, count
begin
  if rising_edge (clk){
    co_pwr_time<=co_pwr_time+1;
    if co_pwr_time = 50000000
      co_pwr_time<=0;
    if count = 75
      count<=0;
    else
      count<=count+1;
  }

  if count <=60 {
    PWM_Accumulator<=PWM_Accumulator+1;
    if(PWM_Accumulator>999) --reset counter pwm
      PWM_Accumulator<="0000000000";
    if(PWM_Accumulator<=1000) -- output 5v
      PWM_out<='1';
    else
      PWM_out<='0';
  }

  elsif (count > 60 and count <= 150) {
    PWM_Accumulator<=PWM_Accumulator+1;
    if(PWM_Accumulator>999) --reset counter pwm
      PWM_Accumulator<="0000000000";
    if(PWM_Accumulator<=239) --output 1,4v
      PWM_out<='1';
    else
      PWM_out<='0';
  }
}
end

```

Figure 6. PWM code

2.3.2. Analog Capture Circuit

The ADC interface needs a transducer that aims to divide the sensor voltage V_{OUT} to be sent to ADC in FPGA board. The ADC has a reading range of 2.5 V as shown in Figure 7. In this system we define the input range from $0000_{(16)}$ - $1FFF_{(16)}$. Thus, the range of acceptable voltage is 1.25V. The voltage divider used in this system can be seen on Figure 8. This voltage divider is used to divide V_{OUT} by 4, in accordance with Equation (1).

$$VL = \frac{R2}{R1+R2} VS \quad (1)$$

with:

$VS = V_{OUT}$ from sensor

$R1 = 1\Omega$ resistor

$R2 = 3\Omega$ resistor

$VL =$ load voltage at $R2$

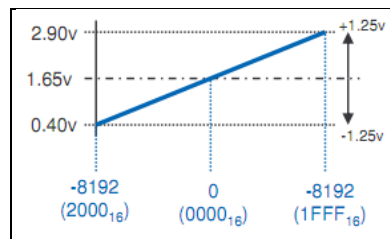

Figure 7. Reading range of ADC in FPGA Spartan 3E [20]

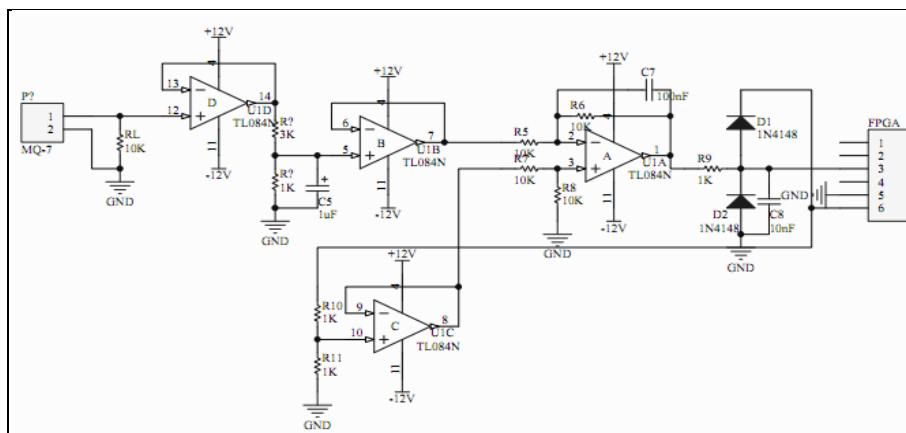

Figure 8. Transducer circuit to divide sensor V_{OUT} by 4

Load voltage (VL) will be unstable if the input voltage is unstable; therefore, it needed another circuit to stabilize the input. This part was conducted by the TL084N IC at pins 12, 13, and 14 at Figure 8. To make the reference voltage 1,65V at ADC to become the new “0” in the range 0 – 125 V, the output from voltage divider was subtracted by 1,65V. The circuit in Figure 8 was connected to ADC J7 connector. This was conducted by modifying the UCF file.

In order to get stable data, 1024 data from the sensor sent to ADC was stored in 1KB RAM first then the average is calculated and given to the other component; the display and the warning components. The schematic diagram to utilize RAM in this process can be seen in

Figure 9. DATA_ACQUISITION is the ADC function that consists of pre-amplifier dan ADC. Data are coming in from SPI_MISO and send out via canal 0 (D_CH0), while D_CH1 is ignored. Then, the digital value from DATA_ACQUISITION is sent to MEM_CONTROL which function is to store the value one by one inside RAM. After the RAM is full, the average value from those 1024 values is then calculated.

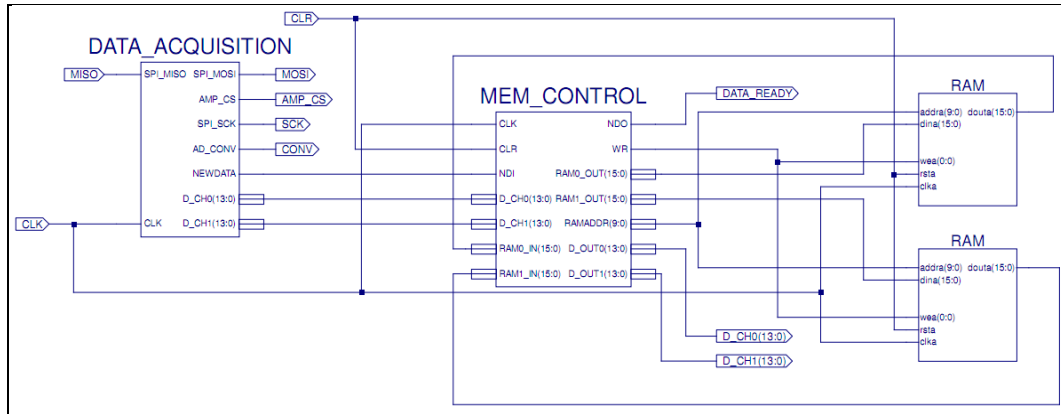
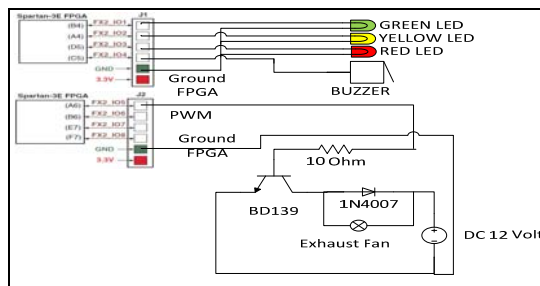

Figure 9. ADC Schematic Diagram

2.3.3. Warning Tools Interfacing to FPGA



(note: 1=FPGA, 2=LED, 3=MOSFET, 4=Buzzer, 5=Exhaust Fan)

Figure 10. Warning system circuit

```

Start
port : clk, data[1024], ppm_sensor, loop_data, av_data, pwm_fan1, pwm_fan2, PPM, rasio,
LED_hijau, LED_kuning, LED_merah, data_ready, buzzer
begin
if rising_edge (clk)
  when loop_data < 1024{
    data[loop_data] <= data from ADC
    av_data = av_data + data[loop_data]
    loop_data = loop_data+1
    if loop_data = 1023 then
      data_ready <= 1
    else
      data_ready <= 0
    end if
  }
if data_ready = 1 then
  av_data = av_data/1024
  rasio = 5 - av_data/av_data
  ppm_sensor = 100/rasio
  if (ppm_sensor < 25) then
    LED_hijau <= 1
  elseif (ppm_sensor < 35 && ppm_sensor >=200) then
    LED_kuning <= 1
    pwm_fan1 <= 1
  elseif (ppm_sensor > 200)
    LED_merah <= 1
    pwm_fan2 <= 1
    buzzer <= 1
  end if
end if
end if
end
    
```

Figure 11. Pseudocode for warning system

The warning system circuit is shown in (note: 1=FPGA, 2=LED, 3=MOSFET, 4=Buzzer, 5=Exhaust Fan)

Figure 10. Expansion connectors that exist on FPGA Xilinx Spartan 3E was used as system controller. LED indicator was connected with three header pins on J1. One pin header on J1 was connected to the buzzer. The output of the PWM pin is connected on the expansion connector J2 which was then connected to the MOSFET circuit for controlling the exhaust fan.

The program pseudocode for the warning tools can be seen on Figure 11 while the corresponding schematic diagram can be seen on Figure 12.

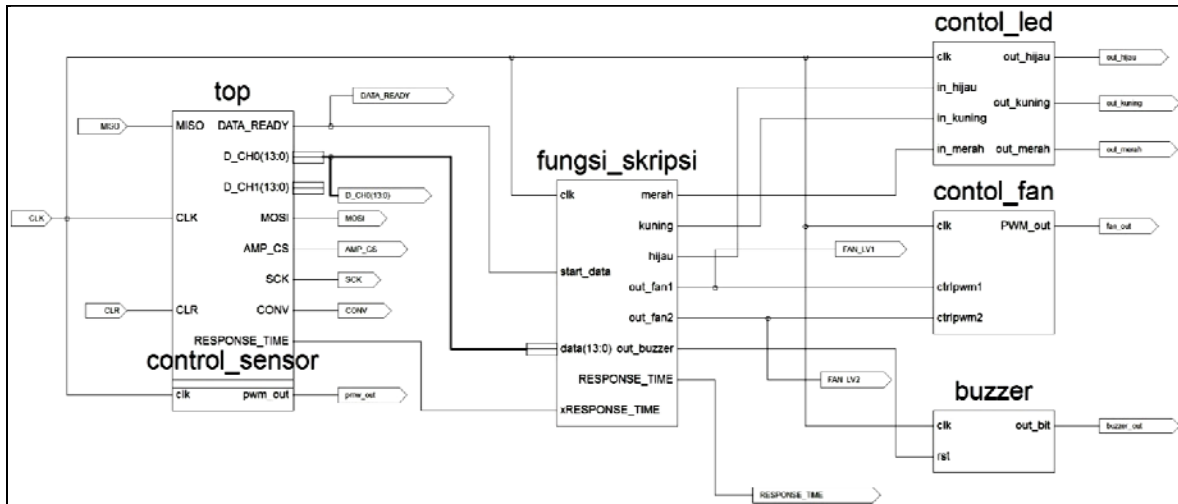

Figure 12. Schematic diagram for warning system

2.3.4. System Interface

The display on 18" wide LCD screen was set to have a black background so that the letters and graph look more contrast so that help the user to see the information displayed on the screen. The screen will display a chart level of CO for the past 30 minutes. The actual condition is shown at the rightmost line of the graph. The dots in the graph will move towards the left side of the screen. The display will also inform the CO level in ppm, and the condition whether it is safe, alert, or in a dangerous situation. The dots in the graph and the condition will have different colors corresponds to the current condition; green when it is safe, yellow when alert, and red when dangerous. The user interface of this system can be seen on

Figure 13.

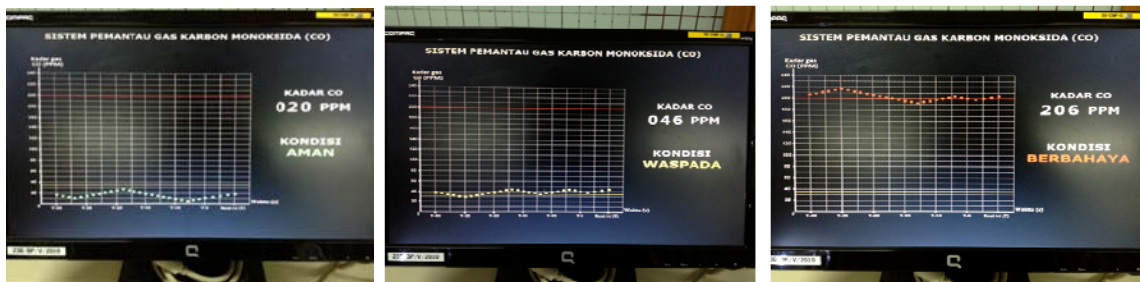

Figure 13. User interface in safe (left), alert (middle), and dangerous (right)

The user interface in on LCD was divided into two parts, the static parts and the dynamic parts [21].

a) Static image

Static image on the user interface was translated into constants form using Imread function in Matlab. The array of the translated image consists of '1' which will be translated as black pixels and '0' which will be translated into white [21]. In this system, graph image and static letters is bundled in one image. Thus we did not need to set the position again in the program. The static image used in the system has 1030 x 788 pixels as shown in Figure 14.

b) Dynamic image

There are 3 dynamic images on the system:

- 1) Dots image in the graph, configured by locating the coordinates and size [ref miecei].

- 2) Letters showing the pollution conditions, which are safe (“AMAN”), alert (“WASPADA”) and dangerous (“BERBAHAYA”), shown in static letters which changed according the CO pollution condition given by the FPGA. The coordinate of the condition is static.
- 3) Numbers, showing CO levels in ppm has the range from 1 to 3 digits of decimal numbers. Each digit need to be placed at the specific coordinates on the display. Therefore, to get each digits-units, tens, and hundreds from the sensor readings, it needs specific pseudocode to be implemented as can be seen in [21].

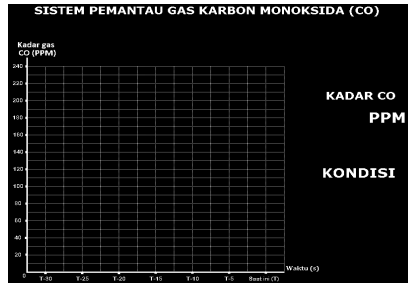

Figure 14. Static Image on the User Interface [21]

3. RESULTS AND ANALYSIS

The system was then tested on a simulation box with an 82-liters volume to check the response of the sensor and the warning systems components. The system was also tested on a real environment in an indoor parking space to evaluate the user interface with a real user as the evaluator.

4.1. CO Gas Readings by Sensor MQ7

We tested if the sensor has worked well and gave response as the characteristic curve in the datasheet. In this testing, we found difficulty in finding comparable tool to calibrate the sensor and to compare the CO reading from the sensor. We also found difficulty to find source of CO that can give varieties amount of CO concentration, because the emission test performed in certified workshop shown that cars produced in recent years have zero CO emission.

Table 2. Sensor Reading of Cigarette Smoke in Simulation Box

Number of Cigarette	Vout (Volt)	CO concentration (ppm)
0	4.390244	20.5
1	3.637833	24.74
1.5	2.431118	37.02
3	1.165501	77.22
6	0.608807	147.83
14	0.254676	353.39

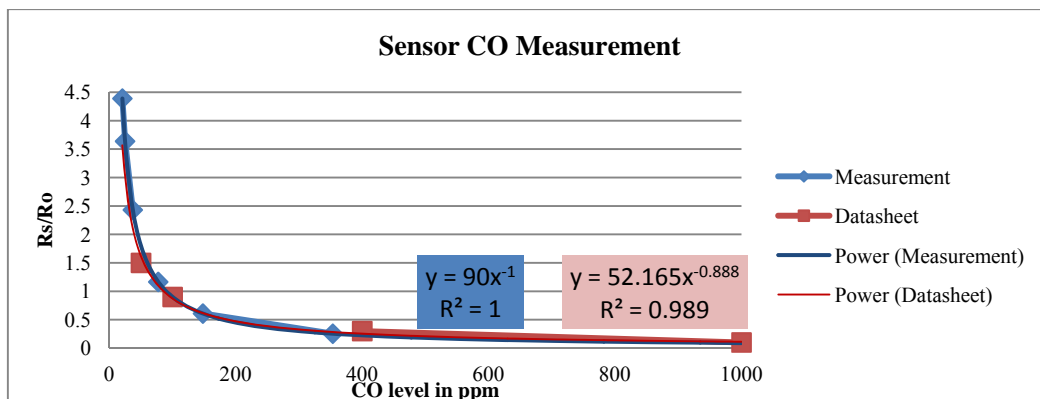

Figure 15. Comparison between CO Sensor Readings with Sensitivity Characteristic Curve in Datasheet

We then decided to use cigarette smoke as the source of CO pollutant. Cigarette smoke was chosen because from the research it was proved that CO pollutant from cigarette smoke was actually higher than auto exhaust [22]. Various amount of CO smoke was given to an 82-liters simulation box and we took a note on the voltage V_{out} given by the sensor to the ADC in FPGA. Table 2 shows the result of this test.

The conversion from V_{out} to ppm value was then compared with the characteristic curve from the sensor in the datasheet and this comparison graph can be seen on Figure 15. We can see that the trend lines of both line graphs are almost coincides. It can be proved that the sensor in the system was worked well and gave response as expected.

4.2. User Interface Usability Evaluation

This testing was performed using questionnaire given to 30 real users as respondents to evaluate the user interface from this system. The average score from each item on the questionnaires was calculated as Mean Opinion Score (MOS) of the user interface. The environment and system conditions at the testing were:

- The display was placed in a mall basement parking area with minimum light.
- The CO data shown in the display was not real data from the sensor, but data inputted directly to the FPGA so that user can see the display changing for variety of CO level and see 3 types of condition, safe, alert and dangerous.

The system evaluation covers three mains parts; overall system, graph and letters. Answers for questions are provided in the form of scale, from 1 (strongly disagree) to 5 (strongly agree). The average user score or the Mean Opinion Score (MOS) of the system was good, which is 4.36 from the 5 scales [21], so that we can conclude that the user interface is good enough to be implemented in indoor parking area.

4.3. System Response Time

We conduct some test to check the response time of the FPGA and the other components. In this test we use digital storage oscilloscope to measure the response time based on the signal width. There are 4 respons time measured to represent the system as a whole:

- Display response time from FPGA to LCD. Testing is conducted using input manually entered using three existing switch on the FPGA board. In this testing, we calculated the response time needed to FPGA to display a single frame. The response time is calculated by measuring the time it takes from the first pixel until the last pixel appear on the screen. Testing was performed by giving output 1 and 0 on FPGA pin and measure the time using an oscilloscope. We inserted a program to count up to 30 times for a single frame display. So the time obtained is 30 times the time required FPGA to display pixels from the first to the last. Data is sampled 10 times. The sample of this measurement can be seen on Figure 16
- ADC Process. Testing is done by using the expansion port J4 on Spartan 3E FPGA to record response time.
- Overall Process in FPGA. Testing is done by calculating the response time when the system receives the data until the data is ready to be issued to the fan, buzzer, LED, and display. Data is sampled for 10 times.
- Sensor readings and transmission to FPGA. Data is sampled for 10 times during the sense phase of the sensor by using oscilloscope. The width of the measured signal is a representation of the changing voltage of the action of the presence of CO gas around the sensor MQ7.

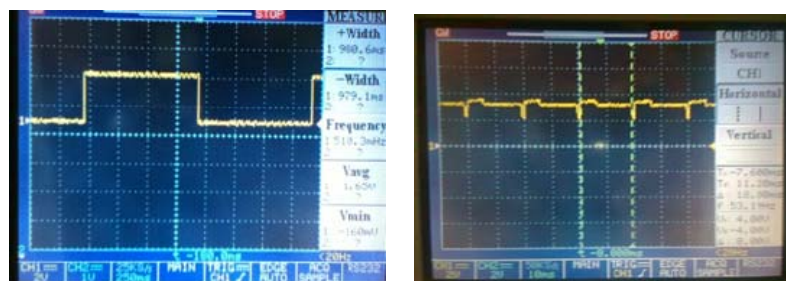

Figure 16. Sample of Response Time Measurement for Display (left) and Sensor (right) Using Oscilloscope

The result of system response testing can be seen on Table 3. From the testing conducted, we can see that the responses time of the system are below 1 s. This is enough for a non critical real time system.

Table 3. System Response Time

Testing parameter	Response time (ms)
Display response time (30 frame)	32.67
FPGA overall process	148.00
ADC process in FPGA	149.10
Sensor	19.11

4. CONCLUSION

A CO pollution warning system for indoor parking area based on FPGA is presented. Together with the implementation of low cost CO sensor, 18" LCD display, and a prototype of warning tools (buzzer, LED, and fan), a new integrated warning system is developed. The main contribution of this work is that a complete and compact pollution detection and warning system could be made using Xilinx Spartan 3E FPGA which categorized as basic FPGA board. The testing results that the system responds under 1 second which suitable for non critical real time embedded system.

ACKNOWLEDGEMENTS

This research was funded by Universitas Indonesia under the "Hibah Awal UI" scheme

REFERENCES

- [1] Centers for Disease Control and Prevention (CDC). Prevent CO Poisoning. [Online]. Available: http://www.cdc.gov/Features/COPoisoning/?s_cid=tw_cdc214. [Accessed 10 November 2011].
- [2] Vivaneews (n.d). Penumpang Bus Ditemukan Tewas Akibat Keracunan Gas Buang. [Online]. Available: <http://www.vivanews.com/embed/video/10139/>. [Accessed 16 November 2011].
- [3] Bataviase.co.id. Tiga Orang Tewas Akibat Keracunan Gas Buang. [Online]. Available: <http://bataviase.co.id/node/275439>. [Accessed 16 November 2011].
- [4] Bataviase.co.id. Diduga Keracunan Gas Buang AC, Enam Penumpang Tewas dalam Mobil. [Online]. Available: <http://bataviase.co.id/detailberita-10505217.html>. [Accessed 16 November 2011].
- [5] H Ratnawati, W Widowati, E Gunawan. Hubungan antara Kadar Karbon Monoksida (CO) Udara dan Tingkat Kewaspadaan Petugas Parkir di Tiga Jenis Tempat Parkir *Jurnal Kedokteran Maranatha*. 2010; 10(1).
- [6] MetroTVnews.com. Alat Ukur Polusi Udara dipasang di Bundaran HI. [Online]. Available: <http://metrotvnews.com/index.php/metromain/news/2009/10/27/4945/Alat-Ukur-Polusi-Udara-Dipasang-di-Bundaran-HI>. [Accessed 16 November 2011].
- [7] Bataviase.co.id. Masih Minim Alat Pengukur. [Online]. Available: <http://bataviase.co.id/node/814557>. [Accessed 23 November 2011].
- [8] Conspec Controls. [Online]. Available: <http://www.conspec-controls.com/>.
- [9] Manning System. [Online]. Available: <http://www.manningsystems.com/>.
- [10] AR Al-Ali, I Zualkernan, F Aloul. A Mobile GPRS-Sensors Array for Air Pollution Monitoring.
- [11] E Ozkan, H Ozdemir, CO Sakar, G Demir, A Unal. Online Detection and Analysis System for Air Pollution Hot Spots in Turkey. *2nd International Conference on Biotechnology and Environment Management*, Singapore. 2012.
- [12] KK Khedo, R Perseedoss, A Mungur. A wireless sensor network air pollution monitoring system. *International Journal of Wireless & Mobile Networks*. 2010; 2(2).
- [13] MA Hussein. Design and implementation of a cost effective gas pollution detection system. *International Conference on Computer and Communication Engineering*. 2012.
- [14] Xilinx Inc. Xilinx Spartan 3E. Januari 2011. [Online]. Available: <http://www.xilinx.com>. [Accessed 6 November 2012].
- [15] JP Nicolle. How FPGAs Work. September 2009. [Online]. Available: <http://www.fpga4fun.com/FPGAinfo2.html>. [Accessed 20 November 2011].
- [16] Centers for Disease Control and Prevention (CDC). Frequently Asked Questions. [Online]. Available: <http://www.cdc.gov/co/faqs.htm>. [Accessed 16 November 2011].
- [17] United States Environmental Protection Agency. Six Common Air Pollutants. [Online]. Available: <http://www.epa.gov/air/urbanair/>. [Accessed 16 November 2011].
- [18] M Hadiyani. Keracunan Karbon Monoksida. [Online]. Available: <http://www.pom.go.id/public/siker/desc/produk/RacunKarMon.pdf>. [Accessed 16 November 2011].
- [19] Washington State Department of Labor and Industries. Carbon Monoxide. [Online]. Available: <http://www.lni.wa.gov/Safety/Topics/AtoZ/CarbonMonoxide/>. [Accessed 6 November 2012].
- [20] All Programmable Technologies from Xilinx Inc. [Online]. Available: <http://xilinx.com>.
- [21] P. D. Purnamasari and E. G. Sumbayak. User Interface for Indoor CO Pollution Monitoring System using FPGA. *Makassar International Conference on Electrical Engineering and Informatics (MICEEI) 2012*, Makassar. 2012.
- [22] D Jaffe, L Chavasse. Comparing The CO Content of Cigarette Smoke and Auto Exhaust Using Gas Chromatography. *J.College Sci. Teaching*. 1999; 172-176.

- [23] [Online]. Available: http://pressexposure.com/FPGA_vs_CPLD_vs_Microcontroller-142920.html. [Accessed 23 November 2011].
- [24] [Online]. Available: <http://www.differencebetween.net/technology/difference-between-asic-and-fpga/>. [Accessed 23 November 2011].
- [25] Hanwei Electronics Co. LTD. Technical Data MQ7 Gas Sensor. [Online]. Available: <http://www.sparkfun.com/datasheets/Sensors/Biometric/MQ7.pdf>. [Accessed 11 November 2011].