

## Determination of Fault Location and Type in Distribution Systems using Clark Transformation and Neural Network

M. Sarvi\*, S. M. Torabi\*\*

\* Faculty of Electrical Engineering, Imam Khomeini International University, Qazvin, Iran

e-mail: sarvi@ikiu.ac.ir

\*\* Semnan Electrical Power Distribution Company

e-mail: s.makan.torabi@gmail.com

---

### Article Info

#### Article history:

Received May 23, 2012

Revised Aug 12, 2012

Accepted Aug 23, 2012

---

#### Keyword:

Fault location

Fault type

Clark transformation

Neural network

Distribution

---

### ABSTRACT

In this paper, an accurate method for determination of fault location and fault type in power distribution systems by neural network is proposed. This method uses neural network to classify and locate normal and composite types of faults as phase to earth, two phases to earth, phase to phase. Also this method can distinguish three phase short circuit from normal network position. In the presented method, neural network is trained by  $\alpha\beta$  space vector parameters. These parameters are obtained using clark transformation. Simulation results are presented in the MATLAB software. Two neural networks (MLP and RBF) are investigated and their results are compared with each other. The accuracy and benefit of the proposed method for determination of fault type and location in distribution power systems has been shown in simulation results.

Copyright © 2012 Institute of Advanced Engineering and Science.  
All rights reserved.

---

### Corresponding Author:

First Author,

An Assistant Professor at the Imam Khomeini International University, Qazvin, Iran.

e-mail: sarvi@ikiu.ac.ir

---

## 1. INTRODUCTION

Distribution networks have special importance in load providing for indoor and industrial consumptions. Fault occurrence in distribution systems is too probable; therefore to guarantee the continuity of service, an accurate fault detection procedure is too necessary. Service quality is main object in a distribution company which is depended on reliability. One of the most important indexes in reliability is System Average Interruptions Duration Frequency Index (SAIDI). Fault classification and fault location method have important role in SAIDI reduction.

Several methods and algorithms for fault location have been presented in the literatures. One of the most common methods for fault location is based on impedance calculating, which is obtained by voltage and current sampling. In this method fault location is obtained from the relationship between fault distance and impedance [1].

Another method is travelling wave based fault location scheme [2]. In this technique, the required fault location information is obtained using the synchronized voltage signals from the first and the end of the transmission line [2].

Voltage Sag Profile tracking is another method for fault location [3-4].

For high impedance faults detection, wavelet transformation method has been proposed in [5-7]. In this method high impedance faults are detected using harmonic current analysis.

In  $\alpha\beta$  space vector method, fault classification is obtained by comparing of characteristics curves (on alpha-beta plan) before and during the fault, also fault location is determined from the relationship between

distance and the eigenvalue of line current matrix [8-9]. The restriction and limitation of this method is dependence of fault location to load for some fault types.

Recently fault detection which is based on neural networks in several papers has been introduced [10-12]. One of the methods uses neural network to fault detections which scrutiny the breakers state and relay status in a feeder and then the destroyed element is identified [10]. This method is presented for small and simple power systems [10].

For major power networks which have too many lines and buses, multiple neural networks are used, in order to time reduction of neural network training. The employment of multiple neural networks is possible in different form, for example a great power system is subdivided into several subsystems and a neural network has been separately introduced for each one of them [11].

In Ref.10, the authors present a hierarchical artificial neural network (HANN) for determining of fault location. This technique identifies fault distance step by step. Applied neural network consists of three classes [12-14]. In other word, problem solution by hierarchical ANN is down through three levels which are low, medial and upper level [12]. This method only determines fault location.

In this paper, a new neural network based method for determination of fault location and fault type is proposed. This network is trained by  $\alpha\beta$  space vector technique and the eigenvalue of line current matrix. The main advantage of the proposed method is that only three phase current sampling for each feeder is sufficient. Also the proposed method is not depending on fault impedance, thus it is useful for determination of fault type and fault location in fault condition with different impedance value. Also high impedance faults can be detected by this method.

This paper is organized as follows. Section 2 describes the proposed method for determination of fault location and type. Simulation results are presented in section 3 to achieve the suitable neural network. In section 4, determination of fault location and fault classification in the radial distribution feeders is presented. Section 5 presents the main conclusions of this paper.

## 2. RESEARCH METHOD

In this section a neural network is proposed to determine the fault type and location. This neural network is trained with suitable parameters. These parameters change regularly with fault type and distance variations. The proposed method fundamentally subdivided in three following stages.

- The first stage is to convert the line current into  $\alpha\beta$  space components using Clark transformation.
- The second stage is to determine the eigenvalue for neural network training in order to identify the fault distance.
- The third stage is to calculate the eigenvector for neural network training in order to identify the fault type.

### 2.1. Convert the Line Current into $\alpha\beta$ Space Components

One of the best de-coupling procedures for three phase line currents is Clark transformation. The static two-phase variables are named "alpha" and "beta". The third parameter is zero-sequence [8].

$$T_c = \begin{bmatrix} 1 & -\frac{1}{2} & -\frac{1}{2} \\ 0 & -\frac{\sqrt{3}}{2} & \frac{\sqrt{3}}{2} \\ \frac{1}{2} & \frac{1}{2} & \frac{1}{2} \end{bmatrix} \quad (1)$$

The first step is to achieve a data sample of the line currents in matrix form as following:

$$S = \begin{bmatrix} i_1(t_0) & i_2(t_0) & i_3(t_0) \\ \vdots & \vdots & \vdots \\ i_1(t_0+(n-1)\Delta t) & i_2(t_0+(n-1)\Delta t) & i_3(t_0+(n-1)\Delta t) \end{bmatrix} \quad (2)$$

Where  $t_0$  is the start time of data sampling and  $\Delta t$  is the sample interval.

The conversion of line current into  $\alpha\beta$  space ingredients is obtained as following:

$$A = T_c \cdot S = \begin{bmatrix} i_\alpha(t_0) & i_\alpha(t_0 + \Delta t) & \dots & i_\alpha(t_0 + (n-1)\Delta t) \\ i_\beta(t_0) & i_\beta(t_0 + \Delta t) & \dots & i_\beta(t_0 + (n-1)\Delta t) \\ i_0(t_0) & i_0(t_0 + \Delta t) & \dots & i_0(t_0 + (n-1)\Delta t) \end{bmatrix} \quad (3)$$

**2.2. The Proposed Neural Network for Determination of Fault Location**

Fault location is obtained from the neural network. This network is trained with eigenvalues. Line currents are characterized by eigenvalues of data sample correlation matrix. Correlation matrix of A is obtained as following:

$$B=AT.A \tag{4}$$

The operator "eig" has been used to achieve eigenvalue of matrix B, as following:

$$[F,C]=eig(B) \tag{5}$$

Where matrix C is as the following:

$$C = \begin{bmatrix} \lambda_\alpha & 0 & 0 \\ 0 & \lambda_\beta & 0 \\ 0 & 0 & \lambda_0 \end{bmatrix} \tag{6}$$

Where  $\lambda_\alpha$ ,  $\lambda_\beta$  and  $\lambda_0$  are eigenvalues of B. Simulation results indicate that only the  $\lambda_0$  eigenvalue has relationship with fault location. Relationship between  $\lambda_0$  and distance for two types of fault are shown in Figures 1-2.

The columns of matrix F (in Eq.5) are defined with eigenvectors f1, f2 and f3. This subject is described in the next section.

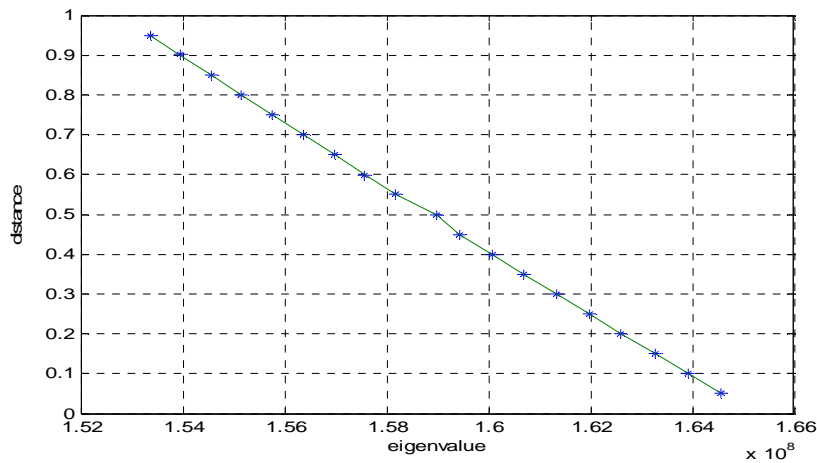

Figure 1. Relationship between  $\lambda_0$  and fault distance for phase A to ground (A-G) fault.

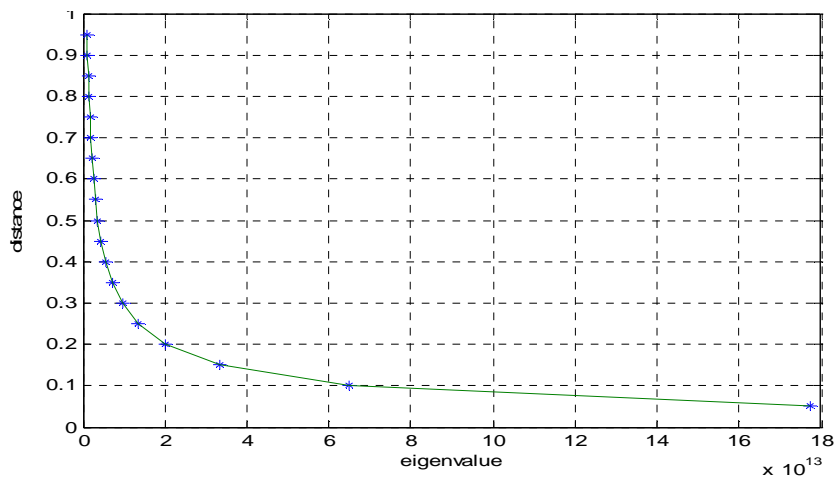

Figure 2. Relationship between  $\lambda_0$  and fault distance for phase A to C and phase B to ground (A-C & B-G) fault.

### 2.3. The Proposed Neural Network For Determination Of Fault Type

Fault classification is obtained by a neural network. This network is trained with eigenvectors of line currents matrix for each type of fault.

Matrix F columns (in Eq.5) are defined with eigenvectors  $f_1$ ,  $f_2$  and  $f_3$ , as following:

$$F=[f_1 \ f_2 \ f_3] \quad (7)$$

Where,

$$\begin{aligned} f_1 &= [f_{11} \ f_{12} \ f_{13}]^T \\ f_2 &= [f_{21} \ f_{22} \ f_{23}]^T \\ f_3 &= [f_{31} \ f_{32} \ f_{33}]^T \end{aligned} \quad (8)$$

Simulation results indicate that the sign of components of matrix F varies according to fault type; therefore each one of fault types constitutes a particular matrix.

The sign of matrix F components, for some different fault types are presented in table 1.

Table 1. The sign of matrix F components for some different fault types

Matrix F:	$f_{11}$	$f_{21}$	$f_{31}$	$f_{12}$	$f_{22}$	$f_{32}$	$f_{13}$	$f_{23}$	$f_{33}$
<i>Fault Type</i>									
A-G	-	+	+	-	+	-	-	-	-
B-G	+	-	+	-	-	+	+	-	-
C-G	+	+	+	-	+	-	-	-	+
A-B-G	-	-	+	-	-	-	+	-	+
C-B-G	+	-	+	-	-	+	+	-	-
A-B	-	-	+	-	-	-	+	-	0
C-B	0	-	+	-	-	0	+	-	-
A-B, C-G	+	+	+	-	-	+	+	-	-
Pre-fault	-	-	+	+	-	0	+	-	0

In fault classification step, the output of neural network is a number. Each number refers to a particular type of fault as shown in Table 2.

Table 2. The output of neural network for determination of fault type

ANN Output	Fault Type	ANN Output	Fault Type
1	A-G	8	B-C-G
2	B-G	9	A-C-G
3	C-G	10	A-B-C
4	A-B	11	A-B, C-G
5	B-C	12	B-C, A-G
6	A-C	13	A-C, B-G
7	A-B-G	14	Pre-Fault

### 2.4. The Block Diagram and Algorithm of The Proposed Method

The block diagram of the proposed method for determination of fault classification and location are shown in Figures 3-4. It includes below main steps:

- The first step is to achieve a data sample of the line currents.
- The second step is mathematical treatment on the achieved data sample using Clark.
- The third step is acquiring the eigenvalue ( $\lambda_0$ ) and eigenvector components ( $f_{11} \dots f_{33}$ ).
- The fourth step is applying eigenvector components ( $f_{11} \dots f_{33}$ ) as inputs of first artificial neural network (ANN). The output of the first ANN is the type of the fault.
- The fifth step is applying eigenvalue ( $\lambda_0$ ) and fault type as inputs of second ANN. The output of the second ANN is the distance of the fault.

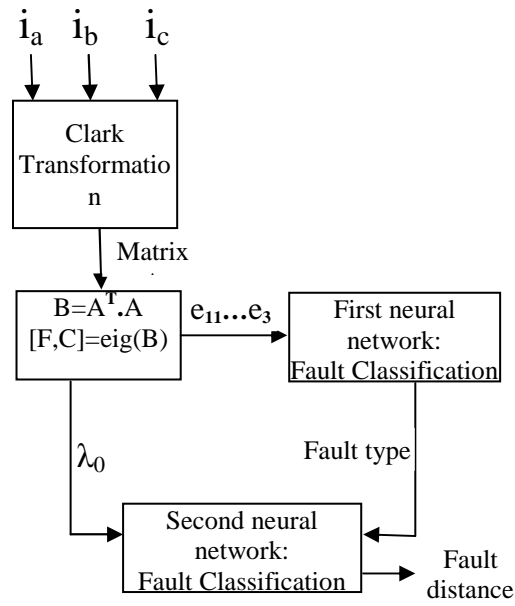

Figure 3. The algorithm for determination of fault type and location

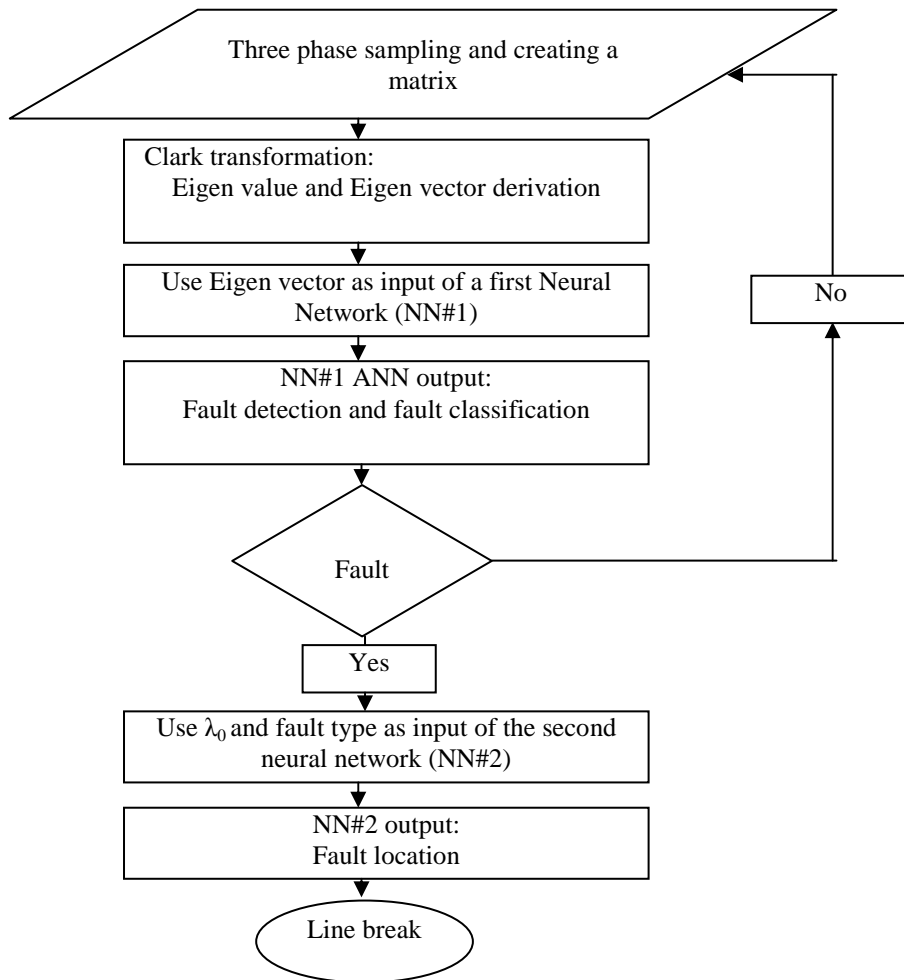

Figure 4. The algorithm for determination of fault type and location.

## 2.5. Determination Of Fault Location And Type With Neural Network

A neural network is defined and characterized by its architecture, input, number of neurons, output, size, and by the training technique that is used to determine its weights. Several architectures have been proposed in the literatures. The best architecture of neural network depends on the type of problem.

In order to obtain an optimum neural network, the simulation results for RBF and MLP neural networks are compared.

## 3. RESULTS AND ANALYSIS

In order to investigate accuracy and quality of the proposed method and to achieve the best neural networks for determination of fault type and location, a typical power distribution system is considered. The main characteristics of this system are as the following:

- Distribution line with:  $S=118 \text{ mm}^2$ ,  $R=0.2791 \text{ } \Omega/\text{km}$ ,  $L= 0.326 \text{ mH/km}$
- Substation power transformer of 10 MVA, 63/20 kV, Y/d, artificial neutral formed for 1 kA
- Load: 2MVA,  $\cos\phi=0.9$
- Substation power transformers of 3MVA, 20/0.4 kV, Dyn
- Phase-phase fault impedance=  $0.0001 \text{ } \Omega$
- Phase-ground fault impedance= $1 \text{ } \Omega$

### 3.1. Determination of fault location and type with neural network

A neural network is defined and characterized by its architecture, input, number of neurons, output, size, and by the training technique that is used to determine its weights. Several architectures have been proposed in the literatures. The best architecture of neural network depends on the type of problem.

In order to obtain an optimum neural network, the simulation results for RBF and MLP neural networks are compared.

#### 3.1.1. Determination of fault location and type with MLP neural network

In this section, in order to achieve the most suitable MLP network for determination of fault location and type, several excitation functions for MLP neural networks with different characteristics are investigated and studied.

To compare between the different types of neural networks results, the absolute error is defined as following:

$$\text{absolute error} = \frac{\left| \text{actual fault location} - \text{calculated fault location} \right|}{\text{total length line}} \quad (9)$$

Total absolute error for whole 13 types of faults is calculated as following:

$$\text{Total absolut error} = \sum_{k=1}^{13} (\text{absolut error})_k \quad (10)$$

In Eq.10, k is the number of fault type, where each number refers to a particular type of fault as shown in table 2.

In order to determination of fault location by MLP neural network, the relationship between eigenvalue ( $\lambda_0$ ) and fault distance is used to train the MLP neural network. The typical MLP excitation functions are logsig, purelin, radbas, staling, satlins, tansig, and tribas.

The total absolute error (in percentage of total length line) for fault location using different excitation functions is shown in Figure 5.

As shown in Figure 5, the total absolute error for fault location using functions purelin, satlins and tansig is less than the error among the defined excitation functions.

The total absolute error for different pair of functions which are used for two layers of MLP neural network has been presented in Figure 6.

As shown in Figure 6, the total absolute error for the third pair of functions (purelin, tansig) is less than total absolute error among other pair of functions. Therefore in ultimate structure for MLP neural network, purelin and tansig are applied for two layers in network.

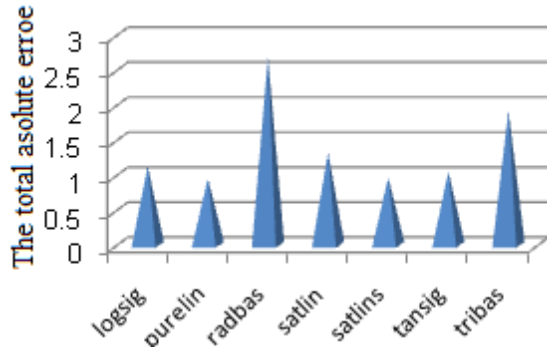

Figure 5. The total absolute error (in percentage of total length line) for fault location by different functions

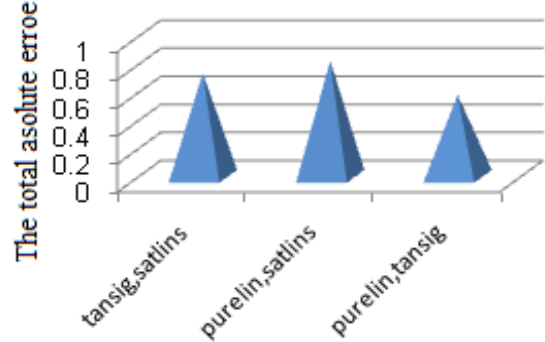

Figure 6. The total absolute error (in percentage of total length line) for different pair of functions

The final step to achieve a suitable neural network is to obtain an optimum number of neurons for MLP network. As shown in Figure 7 the total absolute error of neural network with 6 and 7 neurons in hidden layer, is not significantly less than the total absolute error of the neural network with 5 neurons, therefore a MLP neural network with two layers, (five neurons in hidden layer and one neuron in output layer) has a suitable response. The final MLP neural network for fault location is shown in Figure 8.

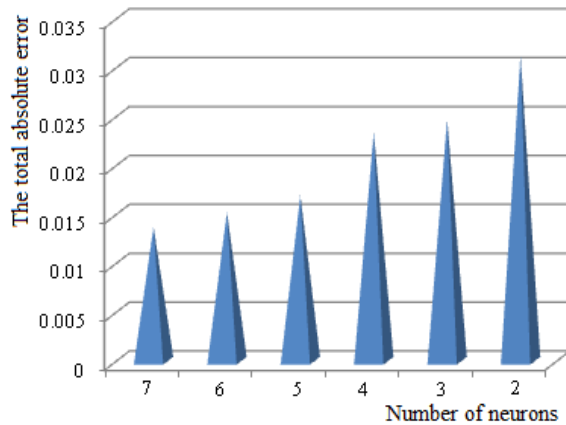

Figure 7. The total absolute error (in percentage of total length line) for different number of neurons.

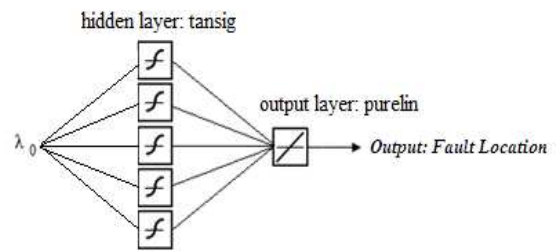

Figure 8. MLP neural network for determination of fault location.

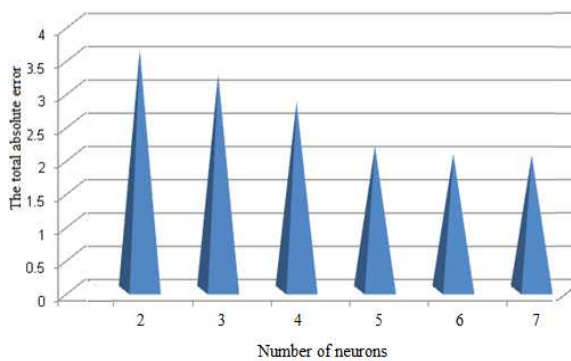

Figure 9. The total absolute error for fault classification with different number of neurons.

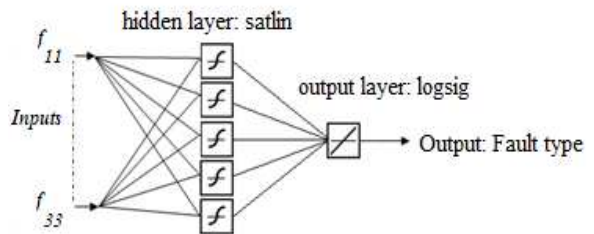

Figure 10. MLP neural network for determination of fault type.

In similar method, a MLP neural network is achieved for determination of fault type. In obtained MLP network, satlin and logsig constitute the best pair of functions which contain the least total absolute error. To select the optimum number of neuron, several networks with different number of neurons are studied. Absolute error for fault classification is obtained as following:

$$\text{absolute error} = |\text{Actual rate (Fault type)} - \text{Computed result(Fault type)}| \quad (11)$$

The total absolute error in vertical axis is obtained from Eq.10.

As shown in Figure 9 the total absolute error of neural network with 6 and 7 neurons in hidden layer, is not significantly less than the total absolute error of the neural network with 5 neurons, therefore a MLP neural network with two layers, (five neurons in hidden layer and one neuron in output layer) has a suitable response as shown in Figure 10.

### 3.1.2. Determination of Fault Location and Type With RBF Neural Network

The function RBF iteratively creates a radial basis network one neuron at a time. Radial basis networks can be used to approximate functions. RBF creates a two-layer network (The hidden layer and output layer). One of the RBF neural network parameters is spread.

It is important that the spread parameter be large enough that the neurons of RBF respond to overlapping regions of the input space, but not so large that all the neurons respond in essentially the same manner. In order to achieve the most suitable RBF network for determination of fault location and type, several RBF network have been studied. The absolute error for fault location is obtain by Eq.9 and absolute error for fault type is obtain by Eq.11 and total absolute error (for vertical axis in diagrams) is obtained using Eq.10.

To obtain a suitable RBF network for fault locating, in the first step several RBF network with different number of neurons are studied, in this step spread parameter is assumed 1. The simulation results are shown in Figure 11. As shown in Figure 11 the total absolute error of neural network 10 neurons in hidden layer, is not significantly less than the total absolute error of the neural network with 9 neurons, therefore RBF neural network with 9 neurons is perfected.

In second step, several RBF network with different value of spread are studied. In this step the number of neurons is considered 9. The simulation results are shown in Figure 12.

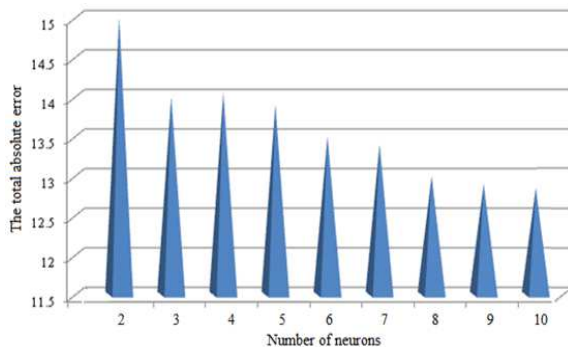

Figure 11. The total absolute error (in percentage of total length line) for different number of neurons.

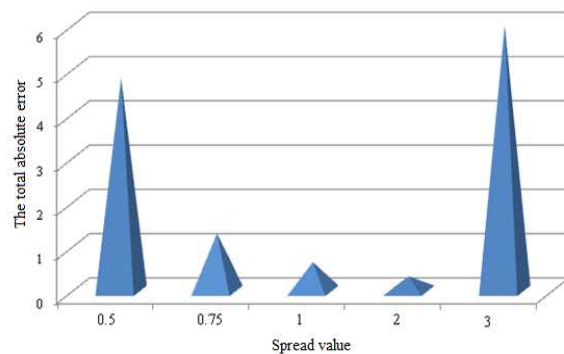

Figure 12. The total absolute error (in percentage of total length line) for different value of spread parameter.

As shown in Figure 12 if spread parameter is 3, then the total absolute error is greater than the total absolute error when the spread parameter is 2, therefore for obtain a suitable RBF the spread parameter is set to 2.

To obtain a suitable RBF network for determination of fault type, in the first step several RBF network with different number of neurons are studied. In this analysis spread parameter is considered 1. The simulation results are shown in Figure 13. As shown in Figure 13 the total absolute error of neural network with 7 neurons in hidden layer, is not significantly less than the total absolute error of the neural network with 8 neurons, therefore the RBF neural network with 7 neurons is perfected.



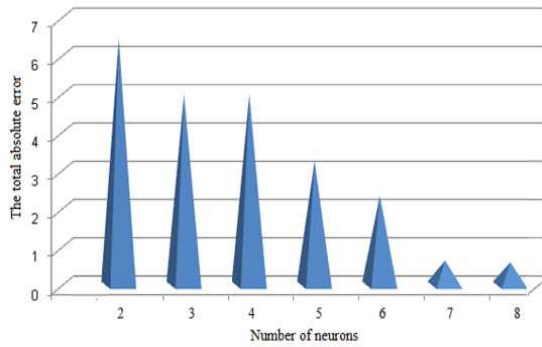

Figure 13. The total absolute error for fault classification with different number of neurons.

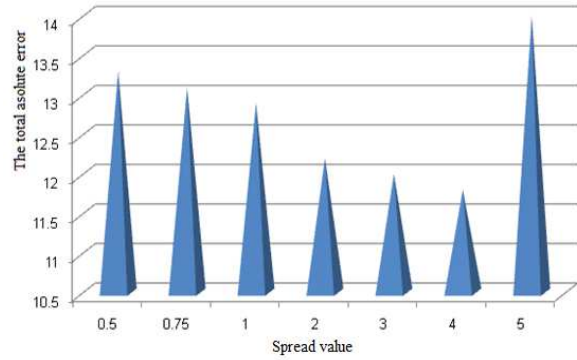

Figure 14. The total absolute error for different value of spread parameter.

In the next step, several RBF network with different value of spread are studied, in this step the number of neurons is 7. The simulation results are shown in Figure 14.

As shown in Figure 14, if the spread parameter is 5, then the total absolute error is greater than the total absolute error when the spread parameter is 4, therefore for obtain a suitable RBF the spread parameter is set to 4.

### 3.2. Comparison of the RBF and MLP neural networks

In order to investigate the quality and accuracy of proposed RBF and MLP neural networks, and to compare them with each other, the simulation results for determination of fault type and location have been presented in tables 3-4.

For determination of fault location, MLP and RBF neural networks have been trained with ten different  $\lambda_0$  which are dependent on ten different fault distances. Also for determination of fault type, MLP and RBF neural networks have been trained with ten different eigenvectors which are dependent on 13 different fault types.

Table 3. Simulation results (fault type) of MLP and RBF neural networks.

Actual rate (Fault type)	Computed result (Fault type)		Error:  actual rate - computed result	
	RBF neural network output	MLP neural network output	for RBF neural network	for MLP neural network
1	0.97	1.3	0.03	0.3
2	1.91	1.67	0.09	0.33
3	3.08	3.25	0.08	0.25
4	4.02	3.78	0.02	0.22
5	5.02	4.64	0.02	0.36
6	6.007	5.55	0.007	0.45
7	7.001	7.35	0.001	0.35
8	8.04	7.85	0.04	0.15
9	9.03	8.93	0.03	0.07
10	9.94	10.12	0.06	0.12
11	11.013	10.74	0.013	0.26
12	12.006	12.36	0.006	0.36
13	12.89	13.42	0.11	0.42

As shown in table 3 the output of RBF neural network for fault classification is more accurate than the MLP neural network output. Therefore for determination of fault type, RBF is more suitable than MLP.

As shown in table 4 the output of MLP neural network for fault location is more accurate than the RBF neural network output, thus for determination of fault location, MLP is more suitable than RBF.

As discussed above in proposed method, RBF neural network is applied for fault classification and MLP neural network is applied for fault location.

Table 4. Fault distance from begin of distribution line (in percentage of total line length) for MLP and RBF neural networks.

Fault type	Actual fault location	FAULT DISTANCE FROM BEGIN OF DISTRIBUTION LINE IN PERCENTAGE OF TOTAL LINE LENGTH (%)		Error:   actual rate - computed result	
		RBF neural network output	MLP neural network output	for RBF neural network	For MLP Neural network
1	65	63.5	65.1	1.5	0.1
2	25	22.1	24.92	2.9	0.8
3	35	31.52	35.21	0.52	0.21
4	37.5	36.12	37.65	1.38	0.15
5	47.5	48.2	47.33	0.7	0.17
6	65	67.23	64.93	2.23	0.07
7	32.5	33.4	32.66	0.9	0.16
8	45	47.1	44.99	2.1	0.01
9	85	82.31	85.13	2.69	0.13
10	37.5	39.1	37.64	1.6	0.14
11	37.5	32.41	37.38	5.09	0.12
12	65	63.5	65.11	1.5	0.11
13	35	30.4	35.15	4.6	0.15

The final flowchart for determination of fault location and type is shown in Figure 15.

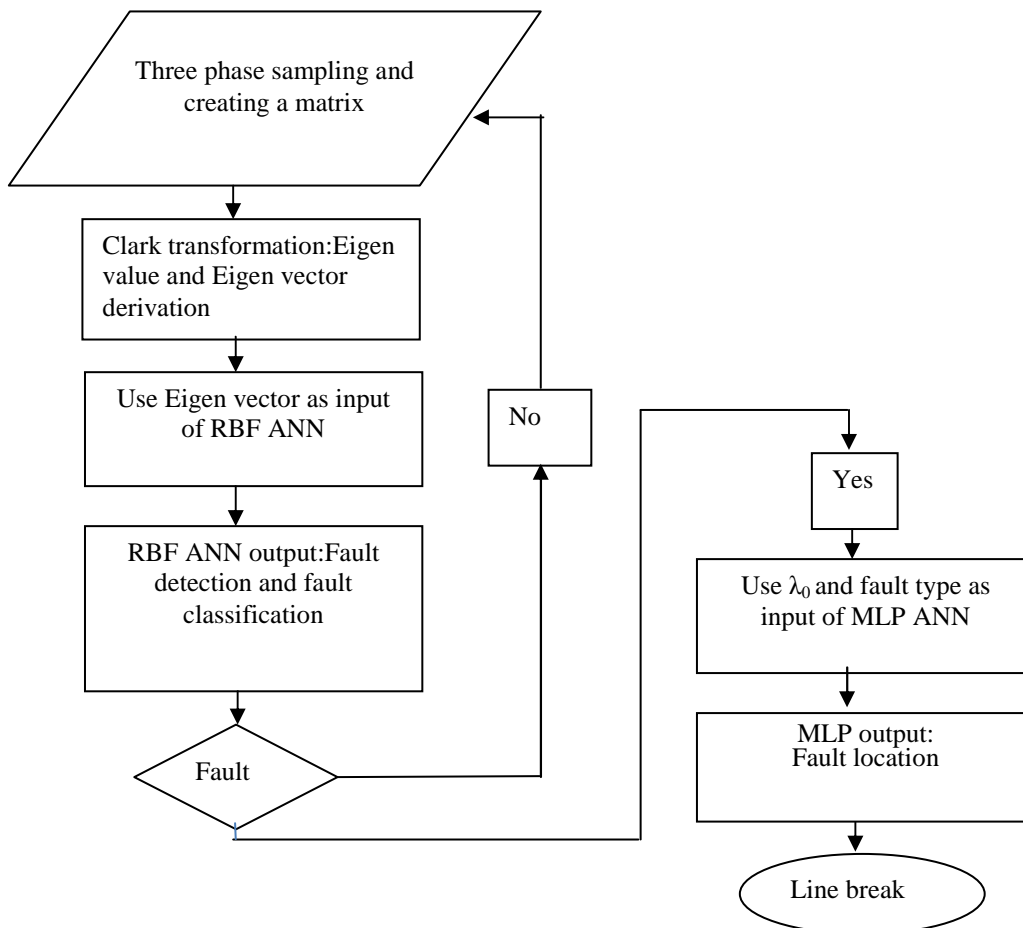

Figure 15. Final algorithm for determination of fault type and fault location.

**4. FAULT LOCATING AND FAULT CLASSIFICATION IN THE RADIAL DISTRIBUTION FEEDERS**

A radial feeder has been shown in Figure 16. The characteristics of the main line and each one of the branches are equal to the line characteristic which are presented in section 3.

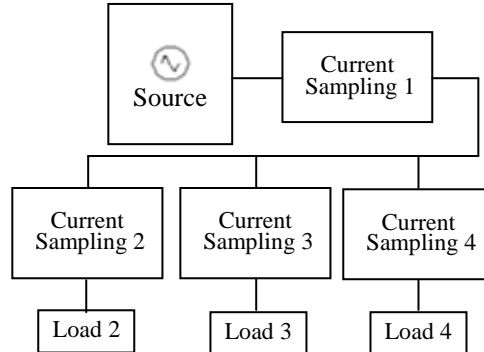

Figure 16. The configuration of a simple radial distribution feeder

In order to determination of fault location and fault type in the radial distribution feeders, in the first step for each one of the branches, the eigenvectors of line currents matrix is analyzed and investigated based on the proposed method. As soon as the faulty branch is detected, determination of fault location is done in the same branch. If all of the branches are at the pre-fault condition, the eigenvectors of main line current matrix is analyzed and investigated based on the proposed method. If the main line is at the fault condition, determination of fault location is done using proposed method in the main line. The simulation results are shown in table 5.

Table 5. The simulation results for determination of fault location and fault type in a branchy feeder

Fault type	Line number	First ANN output: fault type		Actual fault location	Calculated fault location
		Without round operator	With round operator		
In percentage of total line length (%)					
1	1	1.45	1	65	65.6
2	1	1.92	2	25	21.7
3	3	3.24	3	35	36.32
4	1	4.38	4	375	37.38
5	2	4.91	5	47	47.66
6	4	6.31	6	65	64.42
7	3	7.1	7	325	32.65
8	1	8.25	8	45	45.2
9	2	8.83	9	85	85.52
10	3	10.25	10	37.5	37.48
11	4	11.41	11	37.5	37.72
12	3	12.34	12	65	65.13
13	2	12.86	13	35	34.8

**5. CONCLUSION**

In this paper a neural network based method is proposed for determination of fault type and location. The simulation results of two neural network (MLP and RBF) are analyzed and compared. In this method, neural network has been trained with  $\alpha\beta$  space vector parameters.

The main conclusions of the proposed method are as the following:

- All types of faults can be classified in this method.
- In this method the number of inputs is decreased, as determination of fault type and location is down only by the three line currents sampling, where other methods use both voltage and current sampling data together.
- This method is useful for distribution feeders which have several branches, as only the three phase current sampling at the sending end of each branch is enough for determination of fault type and location using proposed method.

- The proposed method is not depending on fault impedance, thus it is useful for fault classification and fault location in fault condition with different impedance value. Also high impedance faults can be detected by this method.
- The RBF neural network is applied for determination of fault type and MLP neural network is applied for determination of fault location.

## REFERENCES

- [1] T. Takagi, Y. Yamakoshi, M. Yamuna, R. Konodow, T. Matsushima, "Development of a New Type Fault Locator Using One-Terminal Voltage and Current Data," *IEEE Trans. on Power Apparatus System*, 101 (1982) 2892-2898.
- [2] M. Bolin, "Travelling-Wave-Based Protection of Double-Circuit Lines," *IEEE Trans on Power Delivery*, 140 (1999) 37-47.
- [3] H. Mokhlis, "A Comprehensive Fault Location Estimation Using Voltage Sag Profile for Non-Homogenous Distribution Networks," *International Review of Electrical Engineering (IREE)*, Vol.5, n.5: 2310-2316, September-October 2010.
- [4] H. Mokhlis, "Evaluation of Fault Location based on Voltage Sags Profiles: a Study," *International Review of Electrical Engineering (IREE)*, Vol.6, n.2: 874-880, March – April 2011.
- [5] I. daubechies, "The wavelet transformation time – frequency localization and signal analysis," *International Review of Electrical Engineering (IREE)*, Vol.5, n.3: 1165-1171, MAY-JUN 2010.
- [6] L. A. Snider, "High impedance fault detection using third harmonic current," *EPRI Report El 2430, prepared by Hughes Aircraft co.* (1980).
- [7] Eldin, El Sayed Mohamed Tag, "Fault Location for a Series Compensated Transmission Line Based on Wavelet Transform and an Adaptive Neuro-Fuzzy Inference System," *International Review of Electrical Engineering (IREE)*, Vol.5, n.3: 1165-1171, MAY-JUN 2010.
- [8] J. B. Faria, "Application of clarke transformation to the modal analysis of asymmetrical single-circuit three-phase line configurations," *ETE European Trans. on Electrical Power*, 10 (2004) 231-255.
- [9] J. B. Faria, "Application of clarke transformation to the modal analysis of asymmetrical single-circuit three-phase line configurations," *ETE European Trans. on Electrical Power*, 10 (2004) 231-255.
- [10] L. Sousa Martins, V. Fernao Pires, C.M. Alegria, "A New Accurate Fault Locating Method using  $\alpha\beta$  Space Vector Algorithm," *Proceedings of the 14th PSCC (2005)* 1-6.
- [11] T. Tanaka, "Design and Evaluation of Neural Network for Fault Diagnosis, Proceedings of the Second Symposium on Expert Application to Power Systems," *Seattle, USA (1989)* 378-384.
- [12] W. Cen, "Power System Fault Diagnosis Based on New Feed Forward Neural Networks," *Proceedings of International Power Engineering Conference (IPEC'93)*, Singapore, (1993) 760-765.
- [13] K. K. Ho, P. I. Keum, "Application of hierarchical neural networks to fault diagnosis of power systems," *International Journal of Electrical Power & Energy Systems*, 15 (1993) 65-70.
- [14] H. Podvin, "Fault location on MV networks," *PMAPS (2000)* 1-6.

## BIOGRAPHIES OF AUTHORS



**Mohammad Sarvi** received his Bachelor in Electrical Engineering in 1998 from the Amirkabir Polytechnic University, and Master and PhD degrees in 2000 and 2004, respectively, from the Iran University of Science and Technology, Tehran, Iran. His research interest includes power electronics and Renewable Energy, FACTs and HVDC. Presently, Dr. Sarvi is an Assistant Professor at the Imam Khomeini International University, Qazvin, Iran.



**Seyyed Makan Torabi** received his Bachelor in Electrical Engineering from Shahrood University, and Master degrees in 2010 from the Islamic Azad University of Saveh, Saveh, Iran. His research interest includes power system modeling and fault detection in distribution system. Presently, Mr. torabi is an engineer at the Semnan Electrical Power Distribution Company, Semnan, Iran.