

# Optimal Selection of LQR Parameter Using AIS for LFC in a Multi-Area Power System

*By* Muhammad Abdillah

## OPTIMAL SELECTION OF LQR PARAMETER USING AIS FOR LFC IN A MULTI-AREA POWER SYSTEM

Muhammad Abdillah <sup>a,\*</sup>, Herlambang Setiadi <sup>b</sup>, Adelhard Beni Reihara <sup>a,c</sup>,  
Karar Mahmoud <sup>d</sup>, Imam Wahyudi Farid <sup>a</sup>, Adi Soeprijanto <sup>e</sup>

<sup>a</sup> Department of Cybernetics, Graduate School of Engineering, Hiroshima University

4-1 Kagamiyama 1chome, Higashi-Hiroshima, 739-8527, Japan

<sup>b</sup> Department of Electrical Engineering, University of Bhayangkara

Jl. Mad Yani 114, Surabaya, Jawa Timur 60231, Indonesia

<sup>c</sup> Department of Electrical Engineering, University of Papua

Jln. Gunung Salju, Amban, Manokwari, Indonesia

<sup>d</sup> Faculty of Engineering, Aswan University

Sahari city-Airport Way, Aswan, 81528, Egypt

<sup>e</sup> Department of Electrical Engineering, Institut Teknologi Sepuluh Nopember,  
Building B. C & AJ Campus ITS Sukolilo Surabaya, East Java, 60111, Indonesia

Received: 30 March 2016; received in revised form: 01 October 2016; accepted: 03 October 2016  
Published online: XX December 2016

### Abstract

This paper proposes a method to optimize the parameter of linear quadratic regulator (LQR) using artificial immune system (AIS) via clonal selection. The parameters of LQR utilized in this paper are the weighting matrices Q and R. The optimal LQR control for load frequency control (LFC) is installed on each area as a decentralized control scheme. The aim of this control design is to improve the dynamic performance of LFC automatically when unexpected load change occurred on power system network. The change of load demand 0.01 p.u used as a disturbance is applied to LFC in Area 1. The proposed method guarantees stability of the overall closed-loop system. The simulation result shows that the proposed method can reduce the overshoot of the system and compress the time response to steady-state which is better compared to trial error method (TEM) and without optimal LQR control.

Keywords: linear quadratic regulator (LQR); artificial immune system; clonal selection; load frequency control (LFC)

### I. INTRODUCTION

Load frequency control (LFC) is one of the main parts on power system where the main function of LFC is to maintain the frequency fluctuation during exchange power in the power system network on which the generator dispatch must satisfy the system conditions caused by the fluctuation of load change [1].

Multi-area power system is a complex dynamic system. The decentralized control design is suitable for multi-area power system because the controller is set to work in each area. The controller works based on the information

only on each area. When any change of output variables in one area occurs, only the controller takes the action in order to maintain the stability from disturbance on its area. The improvement of the dynamic performance caused by small load change has been reported by Robandy *et al.* [2] and the application of optimal control to improve the dynamic performance on power system using linear quadratic regulator (LQR) is provided by Mahmud *et al.* [3]. The method used to improve the dynamic performance on power system by those two previous researches [2, 3] provide satisfactory results. The number of control strategies have been employed in control design of LFC in order to achieve better dynamic performance [4 - 6].

\* Corresponding Author. Tel: +81-8042671315  
E-mail: abdee.muhammad83@gmail.com

Many types of Artificial Immune System (AIS) algorithms are based on the variety of immunological studies such as immune network [7], negative selection [8], danger theory [9] and clonal selection [10]. Clonal selection algorithm (CSA) is a special type of AIS which uses the clonal selection part of the AIS as a main mechanism. Clonal selection is based on a situation of 'B' cell response against nonself-molecule called antigen with an affinity by proliferating and producing antibody in order to kill antigenic cells [11]. AIS via clonal selection is one of metaheuristic methods utilized to solve a complex problem in optimization research field. The optimal solution obtained by AIS via clonal selection is better than optimal solution produced by a genetic algorithm (GA) [12]. Furthermore, the AIS via clonal selection is more efficient than other classical heuristic algorithms such as simulated annealing (SA), tabu search (TB), and genetic algorithm (GA) [13].

AIS via clonal selection had received much attention regarding its potential as a global optimization technique and it has been applied on power system research field as reported in [14, 15, 16]. In [14], AIS via clonal was used for allocating an optimal var compensator in power system. AIS via clonal selection was used to adjust the parameter of PSS based LQR in single machine infinite bus (SMIB) [15]. The authors apply optimal LQR control as PSS to a study dynamic stability. Maryono *et al.* [16] uses AIS via clonal selection for tuning parameter of thyristor controlled series capacitor (TCSC) and PSS for damping controller in power system.

This paper proposes AIS via clonal selection to tune Q and R matrices as to obtain feedback controller gain where applied for multi-area load frequency control (LFC). Some of classical control approaches for LFC are based on mathematical models. These approaches have difficulties in gaining the control purposes in the presence of changing the operating points such as load changes under which the model is derived, and lack of system components. In order to tackle these limitations, an application of intelligent technology is proposed.

In this paper, artificial immune system (AIS) via clonal selection method is utilized to optimize the parameters of LQR. The weighting matrices Q and R of LQR are important parameters which obtaining an optimal feedback gain to improve the dynamic performance of LFC in multi-area power system by observing the change of frequency on each area.

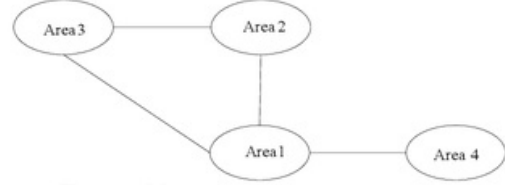

Figure 1. Multi-area power system configuration

This paper is organized as follows: the power system model of LFC for multi-area power system is explicated in section II. The proposed method is introduced in section III. The implementation of proposed method is given in section IV. The simulation results are shown in section V.

## II. POWER SYSTEM MODEL

The configuration of a multi-area power system in this paper is depicted in Figure 1. It consists of 4 LFC areas where each area has number of generators. All generators in one area are simplified as an equivalent generator unit (EGU).

In a certain LFC area the dynamical model of its EGU can be expressed as follows: without generator rates and/or turbine dead-band, the dynamic model can be expressed as linear model in the following equations.

$$\Delta \dot{f}_i = \frac{K_{pi}}{T_{pi}} \Delta P_{mi} - \frac{K_{pi}}{T_{pi}} \Delta P_{te-i} - \frac{1}{T_{pi}} \Delta f_i - \frac{K_{pi}}{T_{pi}} \Delta P_{Li} \quad (1)$$

$$\Delta \dot{P}_{Ti} = \frac{1}{T_{Ti}} \Delta P_{Gi} - \frac{1}{T_{Ti}} \Delta P_{Ti} \quad (2)$$

$$\Delta \dot{P}_{Gi} = \frac{1}{T_{Gi}} \Delta P_{ci} - \frac{1}{T_{Gi} R_i} \Delta f_i - \frac{1}{T_{Gi}} \Delta P_{Gi} + \frac{1}{T_{Gi}} u_i \quad (3)$$

$$\Delta \dot{P}_{ci} = -K_{Ti} B_i \Delta f_i - K_{Ti} \Delta P_{te-i} \quad (4)$$

$$\Delta \dot{P}_{te-i} = \frac{1}{s} (T_{ij} \Delta f_i - T_{ij} \Delta f_j) \quad (5)$$

The linear dynamic model of the  $i$ th LFC area is depicted in Figure 2.

Equations (1)-(5) form a state-space model representation as follow [17].

$$\dot{x}_i(t) = \mathbf{A}_i x_i(t) + \sum_{j=1}^N \mathbf{A}_{ij} x_j(t) + \mathbf{B}_i u_i(t) + \mathbf{F}_i \Delta P_{Li}(t) \quad (6)$$

$$y_i(t) = \mathbf{C}_i x_i(t) \quad (7)$$

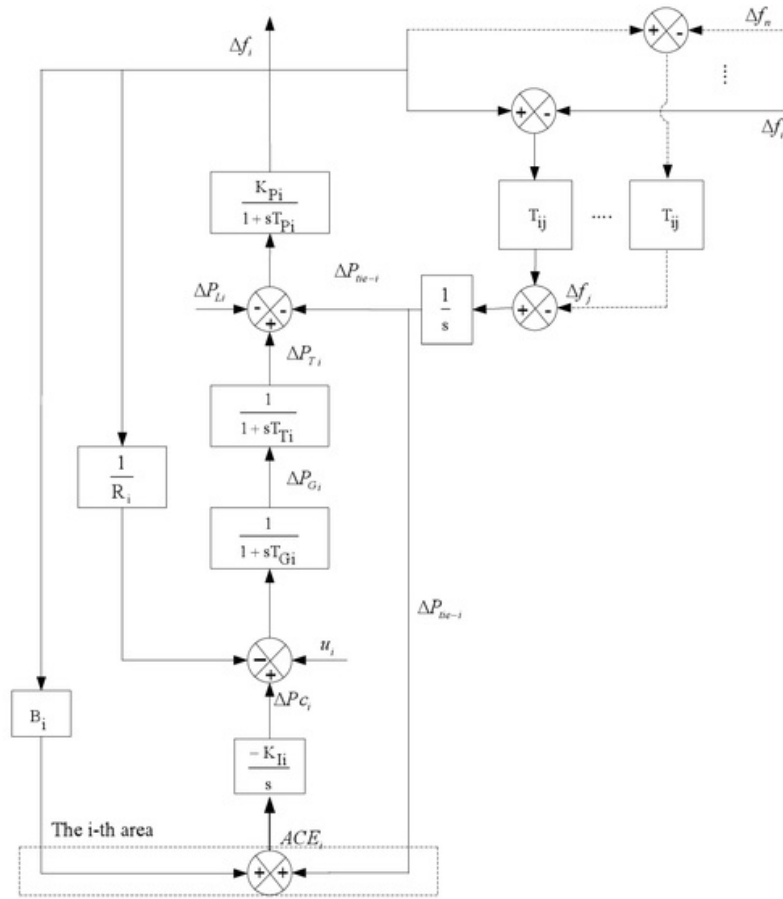

Figure 2. A linear block diagram of the  $i$ th LFC area

where  $x_i(t) \in \mathfrak{R}^n$  is state variable of area  $i$ ,  $u_i(t) \in \mathfrak{R}^m$  is input variable of area  $i$ , and  $y_i(t) \in \mathfrak{R}^r$  is output variable of area  $i$ .

The variables are defined as follows.

$$x_i(t) = [\Delta f_i \ \Delta P_{Ti} \ \Delta P_{Gi} \ \Delta P_{Ci} \ \Delta P_{ne-i}]^T$$

$u_i(t)$  is the  $i$ -th area input signal of  $ACE_i$

$$ACE_i = \Delta P_{ne-i} + B_i \Delta f_i$$

$$y_i(t) = \Delta f_i$$

Definitions of model parameters and variables stated in equations (1) – (7) are shown in Table 1.

By combining 4 EGU's, a block diagram of LFC in the 4 areas power systems can be illustrated in Figure 3. Its state space equation is described as follows,

$$\dot{x}_i(t) = \mathbf{A}_i x_i(t) + \sum_{j=1}^N A_{ij} x_j(t) + \mathbf{B}_i u_i(t) + \mathbf{F}_i \Delta P_{L,i}(t) \quad (8)$$

$$y_i(t) = \mathbf{C}_i x_i(t) \quad (9)$$

Table 1.

Definitions of model parameters and variables

Parameter/ Variable	Description
$\Delta f_i$	The $i$ th area frequency deviation
$\Delta P_{Ti}$	The $i$ th area turbine output deviation
$\Delta P_{Gi}$	The $i$ th area governor output deviation
$\Delta P_{Ci}$	The $i$ th area control input deviation
$\Delta P_{ne-i}$	The $i$ th area net tie-line power deviation
$\Delta P_{L,i}$	The $i$ th area load disturbance
$D_i$	The $i$ th area load damping coefficient
$M_i$	The $i$ th area inertia constant
$R_i$	The $i$ th area governor speed regulation
$T_{Ti}$	The $i$ th area turbine time constant
$T_{Gi}$	The $i$ th area governor time constant
$T_{ij}$	The $i$ th area synchronizing coefficient
$K_{Ii}$	The $i$ th area integration gain
$B_i$	The $i$ th area frequency bias parameter
$K_{pi}$	The $i$ th area power system gain
$T_{pi}$	The $i$ th area power system time constant
$u_i$	The $i$ th area input signal

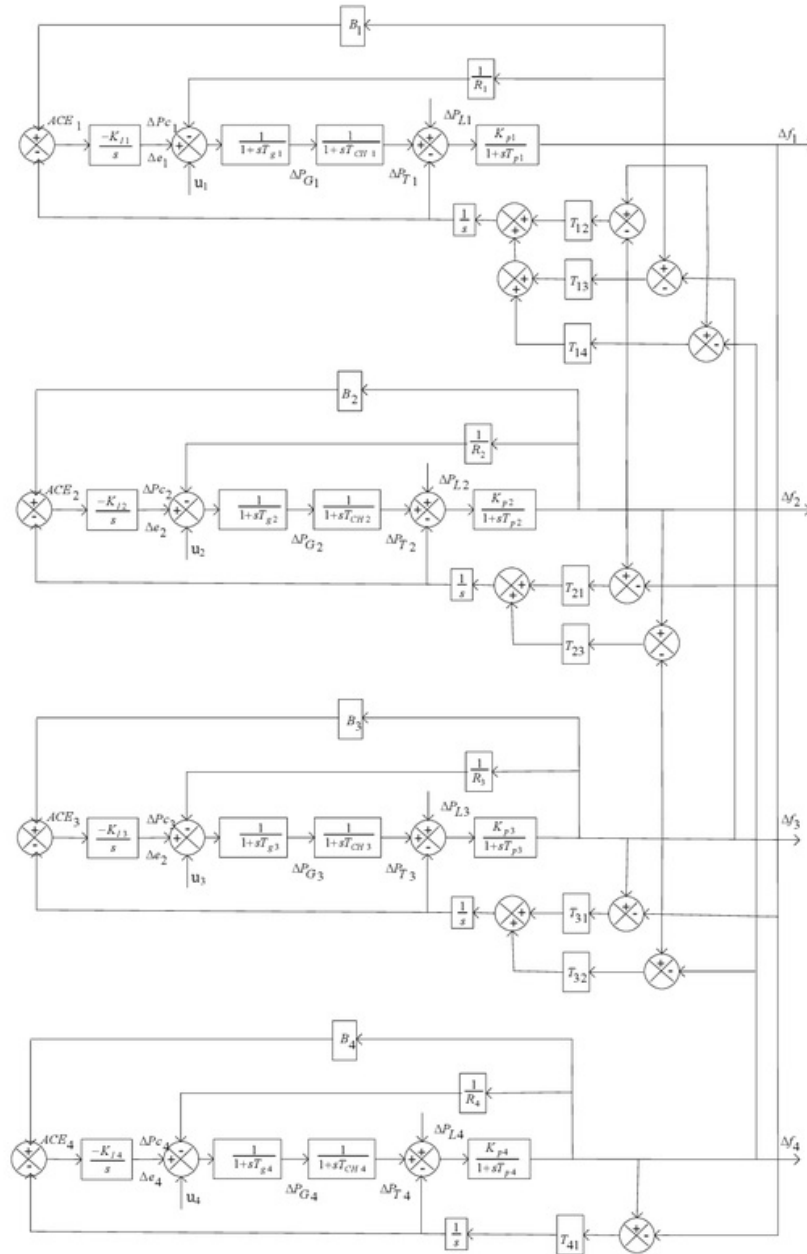

Figure 3. Block diagram of 4 areas LFC power system in linear model

State variable, input variable and output are given by:

$$x(t) = [\Delta f_1 \Delta P_{T1} \Delta P_{G1} \Delta P_{C1} \Delta P_{tie-1} \Delta f_2 \Delta P_{T2} \Delta P_{G2} \Delta P_{C2} \Delta P_{tie-2} \Delta f_3 \Delta P_{T3} \Delta P_{G3} \Delta P_{C3} \Delta P_{tie-3} \Delta f_4 \Delta P_{T4} \Delta P_{G4} \Delta P_{C4} \Delta P_{tie-4}]^T$$

$$u(t) = [u_1 \ u_2 \ u_3 \ u_4]^T$$

$$y(t) = [\Delta f_1 \ \Delta f_2 \ \Delta f_3 \ \Delta f_4]^T$$

where  $\Delta f_1, \Delta f_2, \Delta f_3, \Delta f_4$  are frequency deviation for area 1, 2, 3 and 4, respectively;  $\Delta P_{T1}, \Delta P_{T2}, \Delta P_{T3}, \Delta P_{T4}$  express of turbine output

deviation for area 1, 2, 3 and 4;  $\Delta P_{G1}, \Delta P_{G2}, \Delta P_{G3}, \Delta P_{G4}$  denote of governor output deviation for area 1, 2, 3 and 4;  $\Delta P_{C1}, \Delta P_{C2}, \Delta P_{C3}, \Delta P_{C4}$  refer to control input deviation of area 1, 2, 3 and 4;  $\Delta P_{tie-1}, \Delta P_{tie-2}, \Delta P_{tie-3}, \Delta P_{tie-4}$  stand for deviation in net tie-line power of area 1, 2, 3 and 4.  $u_1, u_2, u_3, u_4$  denote for input signal of area 1, 2, 3, and 4 respectively.

Matrix representation of the state space and output equations of the LFC in 1 areas power system is as follows,

$$A_{ii} = \begin{bmatrix} -\frac{1}{T_{pi}} & \frac{K_{pi}}{T_{pi}} & 0 & 0 & -\frac{K_{pi}}{T_{pi}} \\ 0 & -\frac{1}{T_{Ti}} & \frac{1}{T_{Ti}} & 0 & 0 \\ \frac{1}{R_{Gi} \times T_{Gi}} & 0 & -\frac{1}{T_{Gi}} & \frac{1}{T_{Gi}} & 0 \\ -K_{Li} \times B_i & 0 & 0 & 0 & -K_{Li} \\ \sum_j T_{ij} & 0 & 0 & 0 & 0 \end{bmatrix}$$

$$A_{ij} = \begin{bmatrix} 0 & 0 & 0 & 0 & 0 \\ 0 & 0 & 0 & 0 & 0 \\ 0 & 0 & 0 & 0 & 0 \\ 0 & 0 & 0 & 0 & 0 \\ -2\pi T_{ij} & 0 & 0 & 0 & 0 \end{bmatrix}$$

$$H_{ij} (i \neq j) = \begin{bmatrix} 0 & 0 & 0 & 0 & 0 \\ 0 & 0 & 0 & 0 & 0 \\ 0 & 0 & 0 & 0 & 0 \\ 0 & 0 & 0 & 0 & 0 \\ -T_{ij} & 0 & 0 & 0 & 0 \end{bmatrix}$$

$$B_{ii} = [0 \ 0 \ 1/T_{Gi} \ 0 \ 0]^T$$

$$F_{ii} = [-K_{pi}/T_{pi} \ 0 \ 0 \ 0 \ 0]^T$$

$$C_{ii} = [1 \ 0 \ 0 \ 0 \ 0]$$

The parameters of LFC for the 4 areas interconnection power system are provided in Table 2.

**Table 2.** Parameters of LFC for the 4 areas interconnection power system [17]

Area 1		Area 2		Area 3		Area 4	
$K_{p1}$	120Hz/puMW	$K_{p2}$	112.5Hz/puMW	$K_{p3}$	125Hz/puMW	$K_{p4}$	115Hz/puMW
$T_{g1}$	0.08s	$T_{g2}$	0.072s	$T_{g3}$	0.07s	$T_{g4}$	0.085s
$T_{p1}$	20s	$T_{p2}$	25s	$T_{p3}$	20s	$T_{p4}$	15s
$T_{T1}$	0.3s	$T_{T2}$	0.33s	$T_{T3}$	0.35s	$T_{T4}$	0.375s
$R_{g1}$	2.4Hz/puMW	$R_{g2}$	2.7Hz/puMW	$R_{g3}$	2.5Hz/puMW	$R_{g4}$	2Hz/puMW

$$K_{i1} = K_{i2} = K_{i3} = K_{i4} = 0.6$$

$$B_2 = B_3 = B_4 = 0.425 \text{ puMW/Hz}$$

$$T_{12} = T_{13} = T_{14} = T_{21} = T_{23} = T_{31} = T_{32} = T_{41} = 0.545$$

$$T_{24} = T_{34} = T_{42} = T_{43} = 0$$

### III. PROPOSED METHOD

This paper proposes the well-known optimal linear quadratic regulator (LQR) where the parameters of LQR are optimized by AIS via clonal selection to design load frequency control system.

#### A. Linear Quadratic Regulator (LQR)

Optimal control system based on LQR can be stated as a matter of practical control system then it is desirable to minimize an error function. Its application can be expressed in the form of a block diagram as illustrated in Figure 4.

In order to obtain the necessary control signal  $u$ , amplifier controller  $K$  has to be obtained from LQR method. On the other hand, to keep the system stable, a stable controller is required.

The plant is assumed to be a linear time-invariant (LTI) system which can be expressed in (8) and (9). Based on LQR theory, control signal can be calculated as follows [8].

A quadratic criterion is chosen to optimize the problem with its performance index is as follows,

$$J(t_0) = \frac{1}{2} x^T(T) S(T) x(T) + \frac{1}{2} \int_{t_0}^T [x^T(t) Q x(t) + u^T(t) R u(t)] dt \quad (10)$$

$t_0$  is the initial condition of the system,  $S(T) \geq 0$  (positive semi-definite),  $Q \geq 0$  (positive semi-definite) and  $R > 0$  (positive definite) with the dimension  $Q^{n \times n}$  and  $R^{m \times m}$  respectively.  $S(T)$ ,  $Q$ , dan  $R$  are symmetric shaped weights matrices.

From optimal control theory, the gain and control input are given by the following equations.

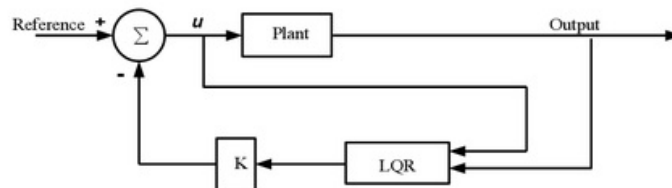

**Figure 4.** Block Diagram Control System

$$K(t) = R^{-1}B^T S(t), \in \mathcal{R}^{m \times n} \quad (11)$$

$$u(t) = -K(t)x(t) \quad (12)$$

$S(t)$  is the solution of the following Riccati equation.

$$-\dot{S} = A^T S + SA - SBK^{-1}B^T S + Q \quad (13)$$

The state space of the closed loop system is

$$\dot{\bar{x}}(t) = (A - BK)x \quad (14)$$

In the closed-loop system matrix, Riccati equation becomes Joseph stabilized formulation as follows

$$-\dot{S} = (A - BK)^T S + S(A - BK) + K^T RK + Q \quad (15)$$

and

$$J(t) = \frac{1}{2} x^T(t) S(t) x(t) + \frac{1}{2} \int_t^T \|R^{-1} B^T Sx + u\|_R^2 dt \quad (16)$$

The performance index on  $[t, T]$  become,

$$J(t) = \frac{1}{2} x^T(t) S(t) x(t) \quad (17)$$

Gain matrix  $K$  in equation (12) which is obtained from equation (11) is substituted into equation (13) then fed it back to the system in order to obtain the minimum output.

15

## B. Artificial Immune System (AIS)

AIS is an optimization algorithm that mimics human immune system. The immune system has the function to protect the human body from the attack of foreign organisms. The immune system has ability to differentiate between the normal components of our organism and the foreign material that can cause harm. The foreign organisms are called antigens. The molecules called antibodies have important role on the immune system response. The immune system response is specific to a certain antigen. When an antigen is known, those antibodies that best identify an antigen will proliferate by cloning. This process is called clonal selection principle. The principle of AIS via clonal selection is illustrated in Figure 5 [10], [11].

Three aspects in clonal selection concept are described as follows,

- The new cells which are submitted to chromosomal mutation chemical mechanism are verily duplicated of their parents.
- Evacuation of newly differentiated lymph cell bringing self-sensitive sensory receptor.
- Development and differentiation on contact of mature cells with antigens.

Sub population of bone marrow cells derived (B lymphocytes) will react by resulting anti-

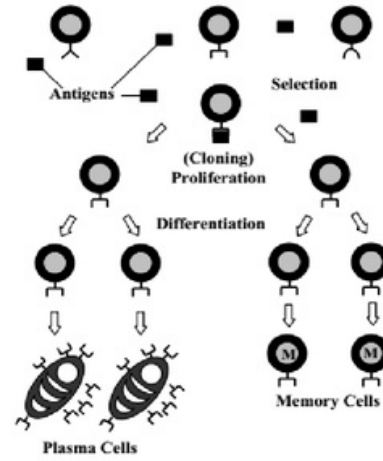

Figure 5. Artificial immune system (AIS) via clonal selection [11]

bodies (Ab) when an antibody is strongly matches to an antigen. Every cell confidential only has one type of antibody which is relatively specific for the antigen.

Antigen is identified by antibody with particular affinity (degree of match), the B lymphocytes will be encouraged to proliferate (divide) and finally grow into terminal (non-dividing) antibody secreting cells, called plasma cell. Proliferation of the B lymphocytes is mitotic process with the help of the cells divides themselves, producing a set of clones identical to the parent cell. The proliferation degree is proportional to the affinity level, i.e. the higher affinity levels of B lymphocyte, the more of them will be readily chosen for cloning and cloned in large numbers. In addition to proliferating and maturing into plasma cells, the immune cells can distinguish into long-lived memory cell. Memory cells distribute through the blood, lymph and tissues and when exposed too second antigenic stimulus they commence into large immune cells (lymphocyte) capable of producing high affinity antibody specific antigen that once stimulated the primary response.

Pseudo code of AIS via clonal selection is described as follows [11].

```

P ← rand(N, L)
While Not Stop condition Do
  For Each p of P Do // presentation
    affinity(p)
  End For
  P1 ← select(P, n) // clonal selection
  For Each p1 of P1 Do // clonal
    expansion
  C ← clone(p1)
End For
For Each c of C Do //affinity
  maturation

```

```

hypermutation(c)
End For 4
For Each c of C Do // presentation
affinity(c)
End for
P ← insert (C, n) // greedy selection
Pr ← rand (d, L)
P ← replace (P, D, Pr) // random
replacement End While

```

The description of parameter for AIS via clonal selection is illustrated in Table 3.

### C. Implementation of Proposed Method

In this section, the implementation of AIS via clonal selection to optimize the parameters of optimal LQR control is described.

The scheme of optimal LQR control is illustrated in Figure 6.  $K_{LQR}$  in Figure 6 is gain for feedback control obtained from solution of equation (13). The AIS via clonal selection serves as a tool to adjust the values contained in Q and R matrices automatically which are very important component of optimal LQR control. Equation (17) is used as the performance index ( $J$ ) of the system which will be minimize in this paper. This function is used as an affinity function in optimization process. 24 vchart of AIS via clonal selection utilized to select the optimal weighting matrices Q and R is shown in Figure 7.

Computation procedure of AIS via clonal selection to obtain optimal LQR parameters depicted in Figure 7 is as follows,

- Generate initial population of antibody: Generate initial antibody in population
- Calculate the objective function (affinity): Performance index used as objective function is defined as follows,

**Table 3.**  
AIS via clonal selection description

Parameter	Description
P	Antibodies' repertoire
N	Number of antibodies 2
N	Antibodies will be selected for cloning
L	Bit string length for each antibody
Nc	Number of clone produced by each selected antibody 2
D	Random number of antibodies to insert at the end of each generation. Best antibodies replace the d lowest affinity antibodies in the repertoire
Stop condition	Maximum generation
2 affinity	Solution evolution
Clone	Duplication of selected bit string
Hypermutate	Modification of a bit string where the flipping 2 bit(it may be single bit or multiple bit) is governed by an affinity proportionate probability distribution

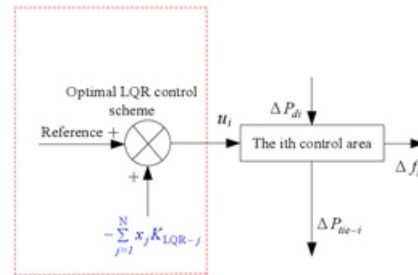

**Figure 6.** Optimal LQR control scheme

$$J(t) = \frac{1}{2} \int_0^{\infty} x^T(t) S(t) x(t) dt \quad 8$$

Subject to,

$$Q_{\min} \leq Q \leq Q_{\max}$$

$$R_{\min} \leq R \leq R_{\max}$$

where  $Q_{\min}$ ,  $Q_{\max}$ ,  $R_{\min}$ ,  $R_{\max}$  are 0, 100, 0, 10, respectively.

- Select the best antibody by measuring their affinities: Affinity is calculated by performance index in step b. Antibody with high affinity is the best antibody in this algorithm.
- Clone best antibody: Antibody with high affinity in population has higher probabilities will be cloned.
- Take into account the population of clones to an affinity maturation scheme: Antibody with lower affinity has higher probabilities will be hyper-mutated.
- Re-select: Every antibody is re-select based on step b.

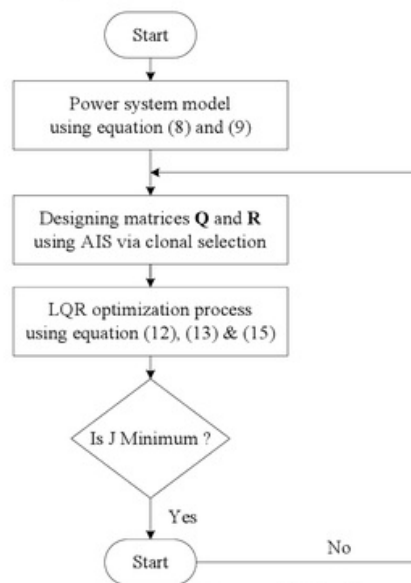

**Figure 7.** Proposed Method



- g. *Replace a new antibody to previous antibody:*  
Antibody with lower affinity will be replaced.

#### IV. NUMERICAL STUDIES

All simulations are implemented on a desktop personal computer with a 2.20 GHz Intel Core i7 processor with 8 GB of RAM using the MATLAB software environment. We set the number of antibodies for AIS via clonal selection to 50, the maximum number of generations to 100 for all areas.

The proposed method is examined by applying the change of load 0.01 p.u on area 1 as disturbance. The convergence curves of AIS via clonal selection for the best affinity values on each area are illustrated in Fig.8

Figure 8 shows that AIS via clonal selection reaches the convergence value at generation 19, 6, 43, 66 for area 1, 2, 3 and 4, respectively. Performance index (PI) value of optimal LQR control on each area is illustrated in Table 4. Although the maximum generation is set to 100, the AIS via clonal selection for area 1 to area 4 had reached earlier than maximum generation for all areas.

The comparison of matrices **Q** and **R** obtained by Trial and Error (TEM) and AIS via clonal selection are listed in Table 5. Frequency deviation and control input deviation for area 1 to area 4 are depicted in Figure 9 (a)-(b) to 12 (a)-(b). From Figure 9 (a)-(b) to 12 (a)-(b), we can observe that the smallest overshoot and settling time are obtained by the proposed method. The values of overshoot and settling time in figures 9 to 12 are shown in Table 6 and Table 7.

**Table 4.**

PI value of optimal LQR control using AIS via clonal selection

Area	$J$ (minimum)
1	0.7824
2	0.2053
3	0.4339
4	0.4092

**Table 5.**

Parameter of optimal LQR control

Area	Parameter of optimal LQR control			
	TEM		AIS via clonal selection	
	Q	R	Q	R
1	0.7	2.4	72.2633	1
	0.7		1.0000	
	0.7		27.3150	
	0.7		4.7557	
	0.7		3.0630	
2	0.7	2.7	14.2810	1
	0.7		94.0000	
	0.7		68.3249	
	0.7		8.0154	
	0.7		3.8331	
3	0.7	2.5	61.2065	1
	0.7		0	
	0.7		39.3815	
	0.7		25.3775	
	0.7		28.6025	
4	0.7	2	94.8829	1
	0.7		0	
	0.7		64.8708	
	0.7		23.3996	
	0.7		7.7552	

From Table 6 and 7, we can observe that the shortest settling time and minimum overshoot of frequency deviation can be obtained by AIS via clonal selection. System without optimal LQR control is the worst; this system used manual gain

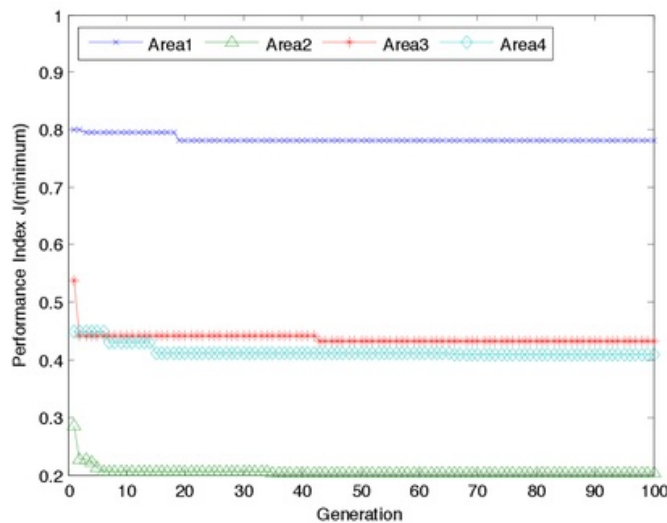

**Figure 8.** Convergence curve of AIS via clonal selection

feedback to produce signal control of the system. The best performance of the system is LFC

equipped by optimal control which was tuned by AIS via clonal selection. If the control input has a

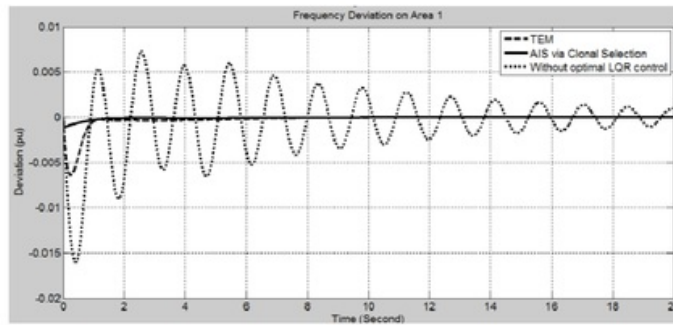

(a) Frequency deviation  $\Delta f1$

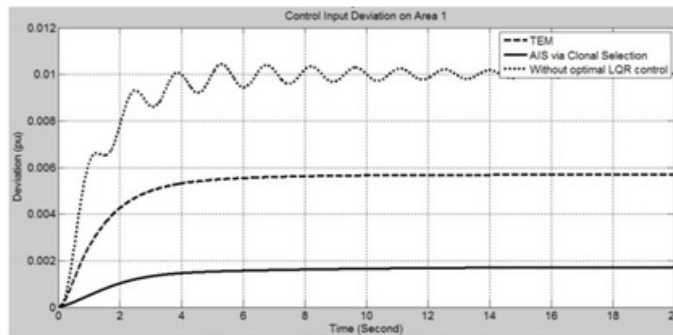

(b) Control input deviation  $\Delta PCI$

**Figure 9.** Frequency and control input deviations on Area 1

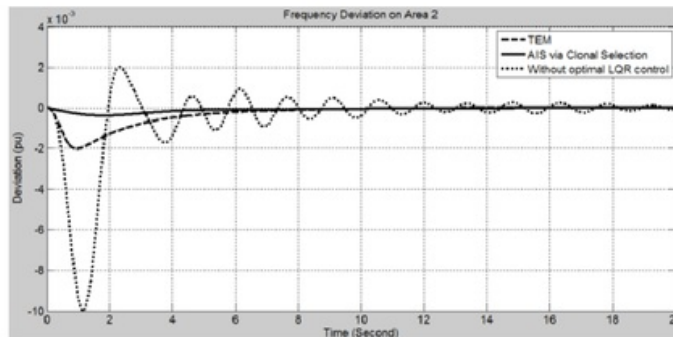

(a) Frequency deviation  $\Delta f2$

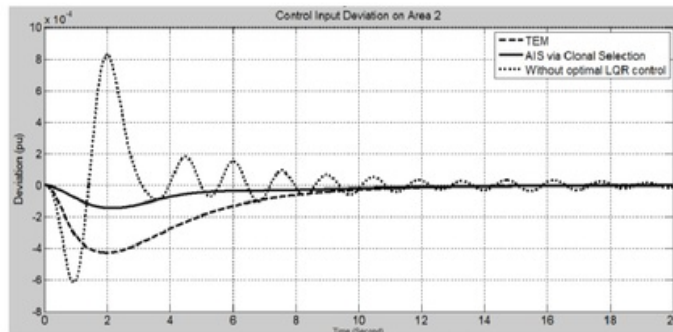

(b) Control input deviation  $\Delta PC2$

**Figure 10.** Frequency and control input deviations on Area 2

good response, less overshoot and faster settling time then the response of the system will be as good as the control input.

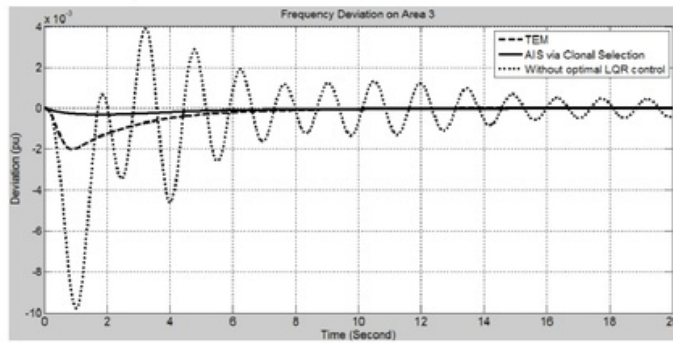

(a) Frequency deviation  $\Delta f_3$

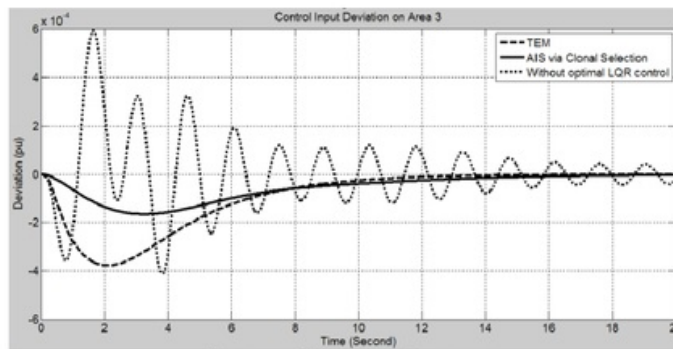

(b) Control input deviation  $\Delta PC_3$

**Figure 11.** Frequency and control input deviations on Area 3

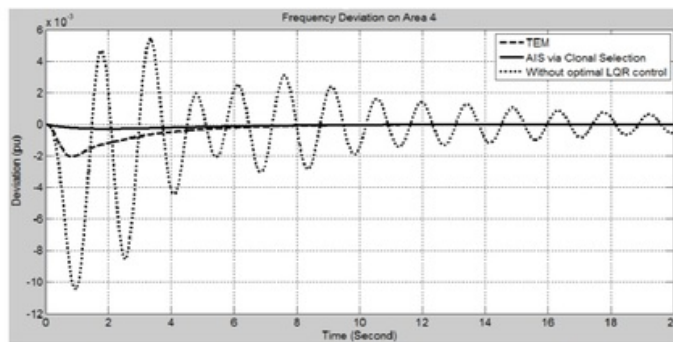

(a) Frequency deviation  $\Delta f_4$

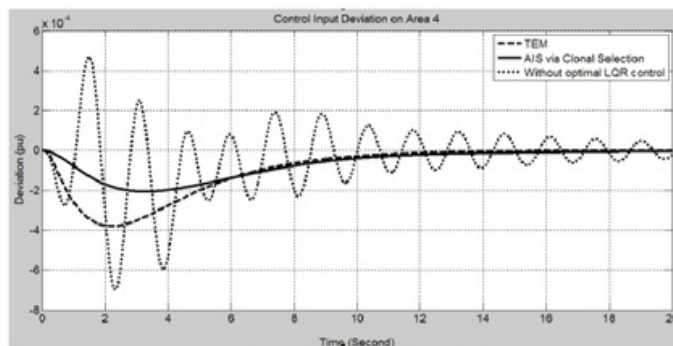

(b) Control input deviation  $\Delta PC_4$

**Figure 12.** Frequency and control input deviations on Area 4

**Table 6.**  
Overshoot (p.u)

Output	Without Optimal LQR Control	Trial-Error Method (TEM)	Optimal Control AIS
$\Delta f_1$	-0.01583	-0.006319	-0.0009466
$\Delta f_2$	-0.009948	-0.001992	-0.0003705
$\Delta f_3$	-0.009625	-0.001986	-0.0003067
$\Delta f_4$	-0.01038	-0.001985	-0.0002702
$\Delta u_1$	0.01043	0.00565	0.001685
$\Delta u_2$	0.0008278	-0.000426	-0.000144
$\Delta u_3$	0.0005908	-0.0003785	-0.0001659
$\Delta u_4$	0.0004677	-0.0003806	-0.000215

6

## V. CONCLUSION

In this paper, Load frequency control (LFC) for multi-area power system network is presented. The impact of LFC control method to maintain the frequency fluctuation caused by load change is examined. An application of AIS via clonal selection to determine the optimal LQR control parameters is provided. The advantage of the proposed method is that it can adjust automatically the parameters of optimal LQR control when there is load change on power system network. Although Trial Error Method (TEM) is simple, it is difficult to obtain optimal control performances. Also, it takes a long time to select the best optimal LQR control parameters. It is clear that optimal LQR control optimized by AIS via clonal selection is more suitable to improve the system dynamic than TEM.

## ACKNOWLEDGEMENT

The authors are grateful to all anonymous reviewers for their valuable suggestions in order to improve the quality of our paper.

## REFERENCES

- [1] R. W. W. Atmaja *et al.*, "Optimal design of PID controller in interconnected load frequency control using hybrid differential evolution-particle swarm optimization algorithm," in *Proceedings of 2014 Seminar on Intelligent Technology and Its Applications*, 2014.
- [2] I. Robandi, "Desain sistem tenaga modern," Penerbit Andi Yogyakarta, 2006.
- [3] M. A. Mahmud, "An alternative LQR-based excitation controller design for power systems to enhance small-signal stability," *International Journal of Electrical Power and Energy Systems*, Vol. 63, pp. 1-7, 2014.
- [4] S. K. Pandey *et al.*, "A literature survey on load frequency control for conventional and

**Table 7.**  
Settling Time (Second)

Output	Without Optimal LQR Control	Trial-Error Method (TEM)	Optimal Control AIS
$\Delta f_1$	>20	8.01	6.34
$\Delta f_2$	>20	7.58	5.32
$\Delta f_3$	>20	7.99	5.90
$\Delta f_4$	>20	7.67	5.12
$\Delta P_{C1}$	>20	9.89	13.57
$\Delta P_{C2}$	>20	10.67	7.13
$\Delta P_{C3}$	>20	17.26	15.11
$\Delta P_{C4}$	>20	16.11	14.29

distribution generation power systems," *Renewable and Sustainable Energy Reviews*, Vol. 25, pp. 318–34, 2013.

- [5] Ibraheem *et al.*, "AGC of two area power system interconnected by AC/DC links with diverse sources in each area," *International Journal of Electrical Power and Energy Systems*, Vol. 55, pp. 297–304, 2014.
- [6] M. R. Sathya, and M. M. T. Ansari, "Load frequency control using Bat inspired algorithm based dual mode gain scheduling of PI controllers for interconnected power system," *International Journal of Electrical Power and Energy Systems*, Vol. 64, pp. 365–74, 2015.
- [7] X. Hao, and S. Cai-xin, "Artificial immune network classification algorithm for fault diagnosis of power transformer," *IEEE Transaction on Power Delivery*, Vol. 22, pp. 930-935, 2007.
- [8] I. Idris and A. Selamat, "Negative selection algorithm in artificial immune system for spam detection," in *Proceedings of the 2011 IEEE Software Engineering*, pp. 379-382, 2011.
- [9] Y. Zhuang *et al.*, "Information security risk assessment based on artificial immune danger theory," in *Proceedings of the 2009 IEEE Computing in the Global Information Technology*, 2009, pp. 169-174.
- [10] M. W. Yaw *et al.*, "Optimization of the multi-flow rate mode selection for pneumatic dispensing valve system using clonal selection based artificial immune system algorithm," in *Proceedings of the 2011 IEEE Control System, Computing and Engineering*, 2011, pp. 327-331.
- [11] L. N. de Castro, and J. Timmis, "Artificial immune system: a novel paradigm to pattern recognition," in *Proceeding of SOCO*, University of Paisley, UK, pp. 67-84, 2002.
- [12] E. Hart *et al.*, "Producing robust schedules via an artificial immune system," in *Proceedings of the International Conference on Electronic Commerce 1998 (ICEC'98)*, April 6-9, 1998.

- [13] E. Hart, and P. Ross, "An immune system approach to scheduling in changing environments," in *Proceedings of The Genetic and Evolutionary Computation Conference 1999 (GECCO '99)*, July 13-17, 1999.
- [14] Y. Li *et al.*, "Improved immune algorithm for reactive power optimization," in *Proceeding of 2013 IEEE Instrumentation and Measurement, Sensor Network and Automation*, 2013, pp. 458-462.
- [15] Z. Haybar *et al.*, "Dynamic power system stability improvement on single-machine power system using optimal artificial immune system power system stabilizer (OpAISPSS)," in *Proceedings of Seminar Nasional Efisiensi dan konversi Energi*, 2006.
- [16] H. Maryono *et al.*, "Coordination of power system stabilizer (PSS) and thyristor controlled series capacitor (TCSC) damping controller using AIS via clonal selection," in *Proceeding of Seminar on Intelligent Technology and Its Applications (SITIA)*, 2006 (In Indonesian Language).
- [17] T. C. Yang *et al.*, "Decentralized power system load frequency control beyond the limit of diagonal dominance," *International Journal of Electrical Power and Energy Systems*, Vol. 24, pp. 173-184, 2002.

# Optimal Selection of LQR Parameter Using AIS for LFC in a Multi-Area Power System

ORIGINALITY REPORT

14%

SIMILARITY INDEX

PRIMARY SOURCES

- 1** Z. TANG. "A Novel Clonal Selection Algorithm and Its Application to Traveling Salesman Problem", IEICE Transactions on Fundamentals of Electronics Communications and Computer Sciences, 10/01/2007  
71 words — 2%  
Crossref
- 2** [www.scribd.com](http://www.scribd.com)  
Internet  
64 words — 1%
- 3** Chien-Yu Lu. "Optimum Design Course Supported by AIS Algorithm", First International Conference on Innovative Computing Information and Control - Volume I (ICICIC 06), 2006  
60 words — 1%  
Crossref
- 4** [www.sudancs.com](http://www.sudancs.com)  
Internet  
53 words — 1%
- 5** Rentian Huang. "Licence Plate Character Recognition Using Artificial Immune Technique", Lecture Notes in Computer Science, 2008  
52 words — 1%  
Crossref
- 6** Kouba, Nour EL Yakine, Mohamed Menaa, Mourad Hasni, Bouziane Boussahoua, and Mohamed Boudour. "Optimal load frequency control in interconnected power system using PID controller based on particle swarm optimization", 2014 International Conference on Electrical Sciences and Technologies in Maghreb (CISTEM), 2014.  
22 words — 1%  
Crossref
- 7** Nakaso, K.. "Synthesis of non-agglomerated nanoparticles by an electrospray assisted chemical vapor deposition (ES-CVD) method", Journal of Aerosol Science, 200307  
21 words — < 1%

- 
- 8 [www.studyblue.com](http://www.studyblue.com) 16 words — < 1%  
Internet
- 
- 9 Wu, Xuan Wang, Hui Yuan, Xiaofang Huang,. "Design and implementation of recursive model predictive control for permanent magnet synchronous mot", Mathematical Problems in Engineering, Annual 2015 Issue 15 words — < 1%  
Publications
- 
- 10 [www.ijert.org](http://www.ijert.org) 15 words — < 1%  
Internet
- 
- 11 Lecture Notes in Computer Science, 2005. 14 words — < 1%  
Crossref
- 
- 12 Iglesias, Andres Galvez, Akemi. "Hybrid functional-neural approach for surface reconstruction.(Research Article)(Report)", Mathematical Problems in Engineering, Annual 2014 Issue 13 words — < 1%  
Publications
- 
- 13 [www.coursehero.com](http://www.coursehero.com) 12 words — < 1%  
Internet
- 
- 14 [www-users.cs.york.ac.uk](http://www-users.cs.york.ac.uk) 11 words — < 1%  
Internet
- 
- 15 Prakash, A.. "A multi-criteria customer allocation problem in supply chain environment: An artificial immune system with fuzzy logic controller based approach", Expert Systems With Applications, 201104 11 words — < 1%  
Crossref
- 
- 16 Anil, Ozgur Durucan, Cengizhan Erdem, R.. "Experimental and numerical investigation of reinforced concrete beams with variable material propert", Construction and Building Materials, Oct 30 2016 Issue 11 words — < 1%  
Publications
- 
- 17 M.B. Abdul Hamid. "Short Term Load Forecasting Using an Artificial Neural Network Trained by Artificial Immune System Learning Algorithm", 2010 12th International Conference on Computer Modelling and 10 words — < 1%

---

18	<a href="#">Lecture Notes in Computer Science, 2007.</a> Crossref	9 words — < 1%
19	<a href="#">www.control.utoronto.ca</a> Internet	9 words — < 1%
20	<a href="#">friends.freakdaddys.com</a> Internet	9 words — < 1%
21	<a href="#">Hettiarachchi, Pradeep M., Nathan Fisher, Masud Ahmed, Le Yi Wang, Shinan Wang, and Weisong Shi. "A Design and Analysis Framework for Thermal-Resilient Hard Real-Time Systems", ACM Transactions on Embedded Computing Systems, 2014.</a> Crossref	9 words — < 1%
22	<a href="#">www.ubhara.ac.id</a> Internet	9 words — < 1%
23	<a href="#">eng.uok.ac.ir</a> Internet	9 words — < 1%
24	<a href="#">Ko, H.S.. "An intelligent based LQR controller design to power system stabilization", Electric Power Systems Research, 200409</a> Crossref	8 words — < 1%
25	<a href="#">nepis.epa.gov</a> Internet	8 words — < 1%
26	<a href="#">e-collection.library.ethz.ch</a> Internet	8 words — < 1%
27	<a href="#">Power Electronics and Power Systems, 2014.</a> Crossref	8 words — < 1%
28	<a href="#">Aircraft Engineering and Aerospace Technology, Volume 88, Issue 6 (2016)</a> Publications	8 words — < 1%
29	<a href="#">Lecture Notes in Computer Science, 2004.</a> Crossref	7 words — < 1%

---



30 Vitoantonio Bevilacqua. "Artificial Immune Systems in Bioinformatics", Studies in Computational Intelligence, 2008 6 words — < 1%  
Crossref

---

31 O. I. Kosmidou. "Guaranteed cost control of systems with norm bounded uncertainties", International Journal of Systems Science, 1987 6 words — < 1%  
Crossref

---

32 "Software Engineering and Computer Systems", Springer Nature, 2011 6 words — < 1%  
Crossref

---

EXCLUDE QUOTES OFF  
EXCLUDE BIBLIOGRAPHY ON

EXCLUDE MATCHES OFF