

Design of Piano-playing Robotic Hand

Jen-Chang Lin, Hsin-Cheng Li, Kuo-Cheng Huang, Shu-Wei Lin

Department of Mechanical Engineering, Minghsin University of Science and Technology, Taiwan

Article Info

Article history:

Received Aug 30, 2013

Revised Feb 27, 2014

Accepted Mar 15, 2014

Keyword:

Entertainment robot

Fast fingers

Piano-playing robot

Robotic hand

Robotic palm

ABSTRACT

Unlike the market slowdown of industrial robots, service & entertainment robots have been highly regarded by most robotics research and market research agencies. In this study we developed a music playing robot (which can also work as a service robot) for public performance. The research is mainly focused on the mechanical and electrical control of piano-playing robot, the exploration of correlations among music theory, rhythm and piano keys, and eventually the research on playing skill of keyboard instrument. The piano-playing robot is capable of control linear motor, servo-motor and pneumatic devices in accordance with the notes and rhythm in order to drive the mechanical structure to proper positions for pressing the keys and generating music. The devices used for this robot are mainly crucial components produced by HIWIN Technology Corp. The design of robotic hand is based on the direction of anthropomorphic hand such that five fingers will be used for playing piano. The finger actuations include actions of finger rotation, finger pressing, and finger lifting; time required for these 3 stages must meet the requirement of rhythm. The purpose of entertainment robot can be achieved by playing electric piano with robotic hand, and we hope this research can contribute to the development of domestic entertainment music playing robots.

Copyright © 2014 Institute of Advanced Engineering and Science.
All rights reserved.

Corresponding Author:

Jen-Chang Lin,

Department of Mechanical Engineering, Minghsin University of Science and Technology, Taiwan

Email: tsang0830@gmail.com

1. INTRODUCTION

The trends of robotics research has been getting more popular in recent years, while there have been continuous appearance of various types of robots in domestic and international media with applications ranging from education, entertainment, medical care, to home care service. This is an indication that the scope of robot application has already been extended beyond the factory and entering our daily lives and various other fields.

The gradually aging population distribution in this century and decreasing annual birth rates among developing countries have led to the aging society and dramatic change to the productivity-generating young/middle-aged/elderly population structures. Thus it can be predicted the imaginary era of robots in future world will soon be developed and realized in human technology world following this trend. Unlike the market slowdown of industrial robots, service & entertainment robots have been highly regarded by most robotics research and market research agencies. In response to the trend and pulse of this era and based on the considerations of manufacturing cost and market demand, education, leisure, and entertainment types of robots are going to be the top choices for future investments. In this study we plan to focus our research on entertainment type keyboard instrument playing robots.

Keyboard instrument includes harpsichord, organ, piano and electronic keyboard, while music tones of specific frequencies are generated by tapping keys by fingers. Keyboard instrument is suitable for solo or accompaniment with wide popularity among general public. Along with the enhanced living standards in our country, piano and electronic The 43rd Intl. Symp. on Robotics (ISR2012), Taipei, Taiwan, Aug. 29 -31, 2012

keyboard have become the important instruments for many families to encourage their children to learn how to play. In light of this popularity of keyboard instrument and the advancement of robotic technology, in this project we plan to develop a robot which is capable of playing keyboard instrument. There have been many music playing robots development in various countries. Toyota Motor Corporation (TMC) [1] in Japan developed Partner Robot in 2004 for the 2005 World Exposition in Aichi, Japan which was specialized in hand motions such as music playing. The first generation of this robot is capable of playing trumpet for the purpose of edutainment. The new model of Partner Robot [2] announced in December 2007 utilized technologies of precise control and coordination for enhancing the flexibilities of palm and arm leading to additional violin-playing feature. The Waseda University in Japan announced WABOT-2 [3] in 1984 as a robot capable of playing organ in accordance with music standard. The next year WASUBOT [4] was announced with additional music score reading feature and capability of playing keyboard instruments with 16 kinds of tunes. Although all aforementioned music robots are capable of creating different music, they have been limited to mechanical finger motions or music playing within small acoustic range, and the instruments in use are limited to certain mechanism while the entire acoustic range has not been fully utilized. We hope the development of this keyboard instrument playing robot can be different from others as a music robot which plays music faster without being limited by certain mechanism. We would like to fully utilize the existing robotic design capability of our school in order to develop a product filled with market potential.

We would like to have the electronic keyboard playing robot developed by this project to play the electronic keyboard with anthropomorphic approach while utilizing linear motor, step motor and pneumatic cylinder to control the mechanism of music playing robot. The mechanical-electrical system we utilize is composed of computer based controllers, where two sets of linear motors sharing the same driver board are used for drive two palms. There are five fingers with each palm, and there are one joint mechanism and one finger mechanism in each finger controlled by step motor and pneumatic device. The step motor, pneumatic device and linear motor are controlled by the system through FPGA controllers. Every note is generated with the robot touching the key in four stages: palm movement (including finger rotation), finger pressing, finger holding, and finger releasing. Upon receiving information of music note and rhythm, the system will determine next targeted position for music playing based on music note information. Figure 1 is composed with anthropomorphic approach.



Figure 1. Overall diagram of mechanical hands

2. DESIGN OF HORIZONTAL HAND MOVEMENT

In automatic production process the linear movement mechanism is the kind of most frequently seen application carrier with degree of freedom of one to multiple dimensions. There is more than one kind of mechanism design for selection. The classification based on movement style will lead to the categories of indirect transmission and direct transmission. The indirect transmission is the most widely used form where rotating movement is converted into linear movement through mechanical mechanism. The common examples of indirect transmission are ball screw mechanism, rack and pinion mechanisms, and conveyor belt. The examples of direct transmission include pneumatic device, hydraulic device and linear motor. For pneumatic and hydraulic devices to achieve energy transmission, fluid must be used as the media. This will not only increase the system complexity, but also lead to various issues such as maintenance and regular service, media replacement, and increased cost. The linear motor with electromagnetic field as the media is capable of greatly reducing system complexity and issues of maintenance and service. The industry has always been pursuing higher precision, more rapid production, and less burden of maintenance, while linear

motor can meet all these criteria. The contact driving system of linear motor has introduced structural revolution for traditional tool machine, automation equipment and inspection instruments with no need for bearings and couplings.

2.1. Analysis of Hand Moving Time

There are numerous factors affecting the moving speed of the mechanical hand. First we can exclude the weight factor and calculate the result of initial stage of hand speed. So far the hand promoter movements can follow several factors such as the interval containing seven keys (C,D,E,F,G,A,B) obtained from research on fundamental acoustic range, the time required for the hand to move from one interval to the next, the study on basic dimension of piano, the length of piano keys, and the hand moving speed from the left-most side to the right-most side. The study shows there are two stages of the sequence of hand movement as shown in Figure 2: the speed of movement from C5 to F5, and the speed of movement from F5 to C6 of the next interval.

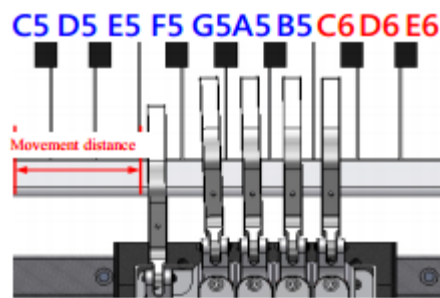

Figure 2. Finger movement position

2.2. Analysis on the Selection of Linear Motor

The movement of mechanical hand is driven by the linear motor. A certain distance of mechanical hand movement will be set for calculation of the speed, acceleration and time required for such movement. As one of the necessary factors for procurement of linear motor, this setting will lead to more accurate speed of linear motor during the movement.

This calculation is based on the relationship between speed and acceleration. The movement of linear motor is different from the operating approach of circular rotary motor such that the calculation of rotation speed and acceleration/deceleration is based on the principle of linear movement. During linear movement, the time needed for a stationary object to be accelerated to the maximum speed is called acceleration time. While the object is moving at maximum speed, it is called the speed of constant speed movement. The time needed for an object to decelerate from this constant speed to the stationary state is called deceleration time. The linear structure of linear motor will lead to fixed motion stroke such that there will be speed planning curves of acceleration, constant speed, and deceleration for the movement speed, and the acceleration, deceleration and time can be calculated by using the formula.

2.3. Calculation of Specification Selection

The following study is to derive required formula of acceleration a (2.1), formula of speed v (2.2), time t and speed curve formula (2.3) based on continuous thrust of linear motor, while the acceleration can be directly calculated from motor output and load. The motor output in this study is based on statistics of production specifications, while the load includes the custom-designed contained mass of mechanical hand, combination mass of motor promoter, and friction (which can be neglected in this study). The following analysis is focused on the time required for the LMC and LMS linear motors of HIWINMIKRO to move the mechanical by 16.5cm.

The LMC series of coreless motors are the first to be analyzed, where the calculation is based on the heaviest mass of contained mass of mechanical hand limited to 2kg. This numeric value is used as the calculation parameter.

2.4. Result of Specification Selection

From the Table 1 below we find that the numeric values of each series of linear motor calculated based on the distance of 16.5cm (60 per minute and quarter note speed 0.1333s) can all meet the standard.

But the difference between sizes of promoter volume is rather large. The same P60 quarter notes all meet standard time, but the volume or promoter of LMC series is smaller than that of LMS series. Thus LMC series is the more suitable linear motor for the piano playing robot of this study due to the visual, aesthetic and performance factors.

Table 1. Time of note

Movement time T:	P30	P60	P90	P120
Quarter note (1 beat)	0.2666	0.1333	0.0888	0.0666
Eighth note (.5 beat)	0.1333	0.0666	0.0444	0.0333
Sixteenth note (.25 beat)	0.0666	0.0333	0.0222	0.0166

In this plan we use LMX1E-C linear motor platform with coreless motor which is suitable for high speed and multi-axis simultaneous movement applications. The compact volume is the main feature, and the increment-type of analog or digital optical scale is used for the position feedback. LMX1E-C platform has superior dynamic features with length up to 4000 mm, maximum acceleration as high as 100m/s^2 , and maximum speed as high as 5m/s . Therefore it is the linear motor meeting the requirement of this project as shown in Figure 3.



Figure 3. LMX1E-C linear motor

3. SYSTEM STRUCTURE OF MECHANICAL HAND

The application of common mechanical hand is limited to grabbing object with anthropomorphic approach. With the space limit of hand design, many sensors and wirings have been installed in the hand such that the flexibility of fingers is limited leading to the lack of dexterity when flexible finger actions are needed. In this study the dexterity of finger has been demonstrated in the form of piano-playing. The piano-playing mechanical hand is based on anthropomorphic design. The hand is slightly wider than human hand at 120 mm, while the appearance of finger is imitating the bending of human finger during piano playing. On one hand it is an imitation of human playing piano, on the other hand it allows only the finger pulp to touch the surface of piano key. The opening and closing actions of hand during piano playing can demonstrate the technical aspect and anthropomorphic effect. As for the chromatic keys, they can be reached by all fingers except for the thumb, and this is the design which has not been seen from previously announced piano-playing mechanical hands.

3.1. Mechanical Hand System

The second generation mechanical hand system includes finger rotary actuator, finger-pressing pneumatic cylinder, finger flexible connection, linear guideway, swinging arm protection device, bottom plate structure, and sliding panel device. The structure of this mechanical hand is as shown in Figure 3.2 “The physical appearance of the second generation hand”, and detailed statistics refer to Table 3.1 “Table of performance parameters of mechanical hand”. The bottom plate of the mechanical hand is mainly 6061-T6 aluminum plate with 4 sets of pneumatic finger-pressing modules and an independent pneumatic thumb-pressing module installed on top of it. There are 4 SBR06 pneumatic cylinders beneath the and bottom plate mainly for the extended actions of 4 sets of modules. Thus there are linear guideways installed at the bottom

of the 4 sets of pneumatic finger-pressing modules mainly for allowing the 4 sets of pneumatic fingers to reach the chromatic keys.

The decomposition of finger pneumatic module of mechanical hand is based on single module, where the servo is used as an actuator at the rotary joint. The actuator is installed in the rectangular groove on the sliding bottom plate with threaded holes on both sides for fixing. When the signal of rotating angle is received by the servo, it will drive the protection swinging arm on top of the servo. This protection swinging arm is installed at the bottom of special rotary joint, and there are threads on the rotary joint for integration with auxiliary clamp plate. There are bearing housings in the auxiliary clamp plate. This pressing plate will be placed on top of rotary joint during installation. The auxiliary clamp plate is installed on the sliding plate where there are holes for fixing and locking. Screws are utilized to penetrate through bearings until the rotary joint is screwed into the thread. This is mainly for reinforcement of the strength of rotary joint where the original structure of cantilever beam is converted to shear free beam for distributing the force on both ends such that the prolonged stress will not lead to the load of the servo motor.

There is the second degree of freedom on the rotary joint for the installation of finger rotation center. There are bearing housings in the fingers for installation of bearings. In the end the penetration of steel shaft is utilized and the E-type ring is used for buckling mainly for avoiding axial movement. Inside the finger there are grooves for integration with flexible device, where flexible devices are connected by using 1mm steel wire. The bouncing back action of finger is achieved by placing compress springs around steel wire. During compression of springs there must be guideways for guiding direction of spring compression such that the steel wire plays an important role in the center of spring. As for the selection of spring, if the wire diameter is too large, the rigidity can be too strong and causing fractures. If the spring is too soft, the finger bouncing-back will not be fast enough to keep up with the beat. The flexible device is connected to the combination of pneumatic cylinder and linear guideway. The pneumatic cylinder is mainly for generating tension with respect to flexible device with stroke around 10mm. The tension is controlled by flow adjustment by throttle valve on pneumatic cylinder. The direction of linear guideway should be kept consistent with the auxiliary force, such that attention must be paid to the interference issue during assembly of linear guideway and pneumatic cylinder, otherwise the response speed of fingers during piano playing can be affected.

As for the identification of corresponding same music alphabet, the number can be used to classify the interval level. The number "5" will be attached to the music alphabet of the key in the same set with central C. Numbers such as "6", "7" are attached to the notes higher than the set of central C, while numbers such as "4", "3" are attached to the notes lower than the set of central C as shown in Figure 4.

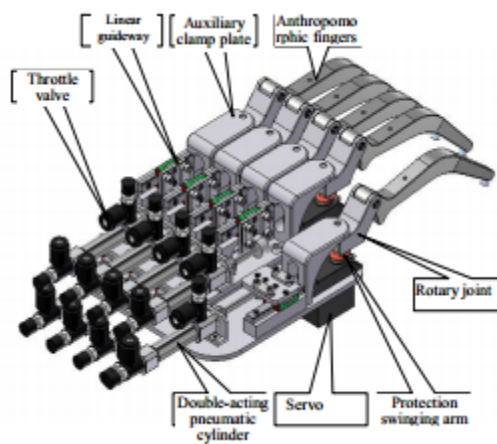

Figure 4. Illustration of the second generation mechanical hand

3.2. Device Design of Mechanical Hand-Rotary Actuator

For the finger rotation of piano-playing mechanical hand, features such as fast rotation, precise position, and compact motor size are required, so is a certain level or torque. Although the required torque force is not too large, certain level of support from rated torque is required. Nonetheless, the most important factor is the size of motor. If the size of motor plus reducer box is too large, the designed mechanical hand will be too large. On the contrary, a smaller motor will lead to a smaller mechanical hand which is more like a human hand. As for the reducer box, the finger motor does not need a very large reduction ratio.

The design of second generation mechanical hand is different from the first generation where the torque transmission by actuator is conducted by direction transmission approach instead of the connecting rod approach. This is mainly due to the additional third degree of freedom installed on the movement joint within the mechanical hand leading to the modified design of the second generation mechanical hand. The protection swinging arm is installed on the servo axis such that there will not be any position sliding during finger rotation with gears of swinging arm and servo axis meshing with each other. The screw fixation approach between protection swinging arm and rotary joint is mainly for facilitating the replacement during maintenance. The principle of protection swinging arm is when the finger is hit by external force, the mandatory rotation under the excitation state of protection servo motor will lead to skipping of internal gear. The appearance dimensions of the actuator installation are as shown in Figure 5.

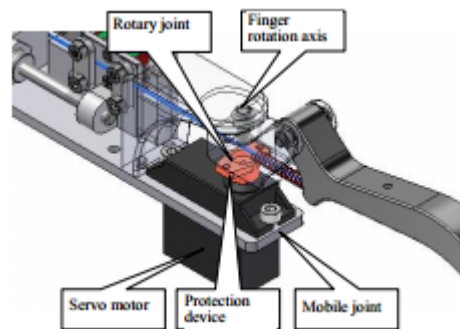

Figure 5. Actuation installation location

The finger rotation is transmitted to the rotary joint through protection device. Since the protection device is a flexible connection part, reaction will be generated during finger pressing process affecting the rotary joint. The protection device cannot withstand such force, thus the auxiliary clamp plate is designed in response to this issue. The auxiliary clamp plate is installed on top of the rotary joint. The reaction will cause the rotary joint to be lifted, and this is when the auxiliary clamp plate can balance the force.

3.3. Device Design of Mechanical Hand-Pressing Actuator

For the finger pressing actions of piano-playing mechanical hand, features such as speed, stability, and compact device size are required. By studying the action of finger pressing the piano key, we find that currently there is no control over force for finger action such that the control device is only handling constant speed movement with fixed stroke. In terms of the volume requirement, there must be 5 actuators placed on the hand for pulling steel wires, thus lie-flat installation is required for the devices to be used in order to prevent the hand from being too thick. In terms of the pressing speed, there must be very fast reciprocating motion in a rather short stroke such that there will not be very high demand on precision. In terms of output force, this finger mechanism will require at least force of 1kgf and above. Summarizing features of all aforementioned device requirements, we conclude that pneumatic cylinder is the best choice. It is equipped with aforementioned features of compact size, short stroke, large force, and high speed. Pneumatic cylinder is a kind of pneumatic driver generating linear movement which has been widely adopted in the industry. Because pneumatic cylinder is capable of generation simple mechanical actions, there are various kinds of pneumatic cylinders with numerous methods of use.

In the design of finger pressing mechanism of mechanical hand, the pneumatic cylinder is used as the actuator in coordination with other auxiliary devices. The reciprocating actions are generated by the pneumatic cylinder to pull finger by pulling connection steel wires. With one end of the finger fixed on a rotation axis, the finger motion of up and down swinging is centering on the rotation axis. When the steel wire is pulling the finger based on the principle of leverage, it is a fixed ratio between the distance from the joint of steel wire and finger to the rotation center, and the distance from finger tip to the rotation center. This is mainly the increase of pressing speed which reduces the movement of pneumatic cylinder. Due to this ratio, the increased speed will lead to reduced action force. When there is larger resistance at the finger tip, larger force is required at the stressing end for achieving balance due to the principle of force arm. For the overall beauty of fingers, this design also prevents the exposed mechanism from being seen during actuation of mechanism such that the overall appearance is a better fit for anthropomorphic design. This is going to

contribute greatly to music playing where more lively music can be played as the demonstration of finger dexterity while meeting the feature of anthropomorphic fingers.

The difference between the design of the second generation mechanical finger and the first generation design is at the position of bending joint. Based on the joint of human hand, the bending position of mechanical hand is at the junction between carpal bone and mid bone. The distance from the finger bending joint to the finger tip is 100mm, while the distance from the junction of steel wire and finger to the bending joint is 17mm. This will lead to a larger ratio such that the pneumatic cylinder only needs to move by 5 mm for the pressing distance to reach 25 mm. This way the speed of finger pressing on the piano key will be greatly enhanced to twice the speed of the first generation. However, in terms of the pressing force, the adoption of old pneumatic cylinder will lead to slightly insufficient force output. The reaction force is increased due to the enlarged force arm of the principle of leverage such that greater force is required at the stressing end in order to achieve the balance. Therefore, in the second generation design we replace the old pneumatic cylinder with the one with outer cylinder diameter of 10mm in order to achieve ideal output force. Figure 6 is about the description of all parts of the second generation finger, and the simulation of pressing action.

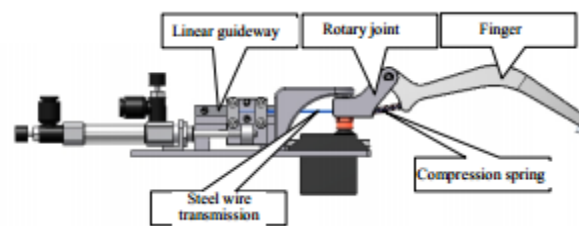

Figure 6. Detailed functions of the second generation hand

3.4. Device Design of Mechanical Hand-pressing Simulation

New design approach has been used with respect to the speed of piano key pressing by the second generation fingers. The distance from the finger bending joint to the finger tip is 100mm, while the distance from the junction of steel wire and finger to the bending joint is 17mm. The speed of finger pressing the piano key can be more obvious through the principle of leverage, while the design of finger appearance has been also imitating the bending of human fingers while playing piano. Through the computer-assisted mechanical drawing, 3D drawing has been utilized for the simulation of finger pressing as shown in Figure 7 and Figure 8.

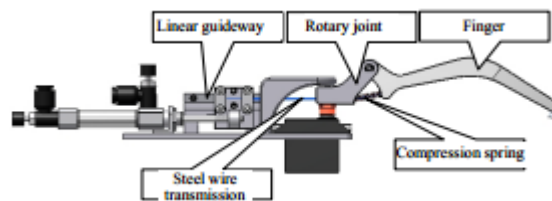

Figure 7. Simulation of finger pressing (front)

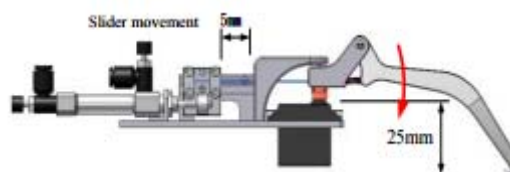

Figure 8. Simulation of finger pressing (rear)

3.5. Device Design of Mechanical Hand – Pressing Assistance Guideway

Linear guideway has been utilized, while the coordination of mechanism is based on the connection between pneumatic cylinder and linear guideway through steel wire clamp plate. The steel wire is fixed between the pneumatic cylinder and the linear guideway such that when the force is transmitted from the pneumatic cylinder to the steel wire, it is not easy for the torque generated during pulling of steel wire to lead to increased friction of the linear guideway. Based on this design, there is one module per finger installed in the hand. Due to the size factor, the linear guideway must be fixed on the hanger in side-lying fashion. There are 2 M2 threads on the slider for fixing the steel wire clamp plate on the slider and for fixing the axis of pneumatic cylinder beneath the slider. There are two aluminum plates on the steel wire clamp plate for clamping the steel wire. The double clamping approach can ensure the steel wire not to be loosened while being pulled. The Figure 9 below is the description of pressing design of the second generation mechanical hand.

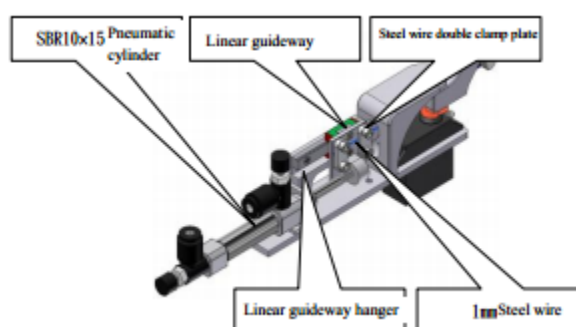

Figure 9. The second generation pressing design

3.6. Device Design of Mechanical Hand – Pressing Assistance Guideway

In the system design of the second generation mechanical hand, the opening angle is required by the fingers. Based on the design principle of the first generation mechanical hand, the finger itself must be equipped with two degrees of freedom. However, in the finger design of the second generation mechanical hand, a third degree of freedom must be added, which is the position required for the fingers to hit the chromatic keys during piano playing, while the appearance must be even more anthropomorphic. Based on these two criteria, the finger design of the second generation mechanical hand must have 3 degrees of freedom, where the third degree of freedom is for the finger to be extended to the position of chromatic key. The basic actuation principle is similar to the first generation mechanical hand. The difference is the pneumatic cylinder is installed in the hand on a sliding module such that the finger module can be moved as an entity. Therefore the pressing module itself must have two degrees of freedom. In terms of the module, the action force generated by the pneumatic cylinder is transmitted through the flexible device. The pneumatic cylinder is installed in the rear of the finger mainly for avoiding the friction loss during force transmission. The flexible device we use is 1mm steel wire. The path of steel wire is almost a straight line during transmission for generating enough force for finger pressing. When the finger is opened by a certain angle, the steel wire will be bent with an angle. This angle is not very large, and the steel wire is introduced into the rotary joint with the tangent approach, such that the transmission of steel wire is based on an arc angle rather than a right-angle bending. This bending is within the bending range of 1mm steel wire. The appearance of the second generation mechanical hand is as shown in Figure 10.

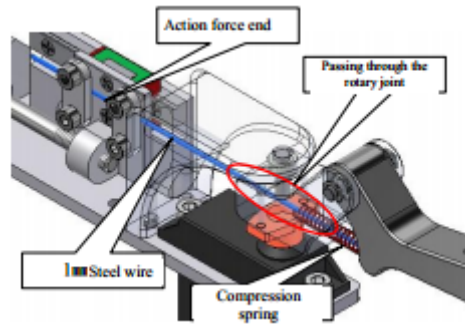

Figure 10. Mechanical finger flexible transmission design

3.7. Device Design of Mechanical Hand – Gliding Joint

First of all the relationship between the chromatic keys and the mechanical hand is analyzed. During normal piano-playing process the fingers of mechanical hand are placed on the white keys. Whenever the chromatic keys need to be pressed during piano-playing, the mechanical hand will be moved to the proper position, while the finger for pressing the chromatic key will be stretched to the position and the finger will be pressing down. After the pressing action is completed, the hand will return to the normal state. The finger pressing process is simulated by computer software as shown in the following Figure 11 and Figure 12.

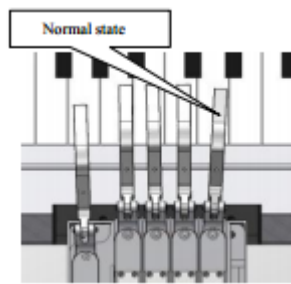

Figure 11. Mechanical fingers (normal position)

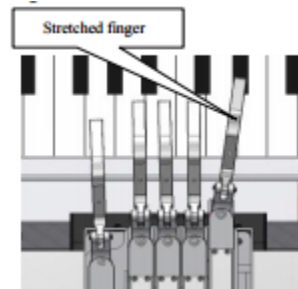

Figure 12. Mechanical fingers (stretched)

The distance from the finger position on the white key to the finger position on the chromatic key is 30 mm, the width of chromatic key is around 8 mm, and the width of buffer silicone at finger tip is 6 mm. Therefore, there is only 1 mm tolerance of left/right deviation during finger pressing process, which is very important to the stability after stretched mechanism. There is a drop height between the white key and the black key, which means the black key is 15 mm above the white key. Therefore, for fingers to reach for the chromatic keys while playing on white keys, they must be lifted. However, the actuation of mechanism must be in a stable state such that the heights of fingers and keys will be raised by a certain distance during piano-playing on the white keys. The dimensions of the design appearance are as shown in Figure 13 and Figure 14.



Figure 13. Heights of fingers and white keys

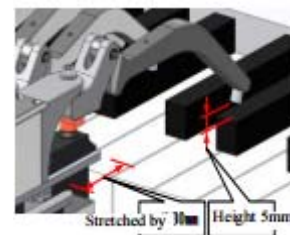

Figure 14. Heights of fingers and black keys

3.7. Device Design of Mechanical Hand – Gliding Joint Module

In the mechanical hand design, fingers are designed with modularization approach. A finger is designed to be a module capable of pressing the piano key and rotating by a certain angle, such that a mechanical hand is composed of four identification finger modules and one thumb module. As mentioned in previous chapters, the finger module includes servo motor, pneumatic cylinder, linear guideway and flexible transmission device. All devices will be integrated on one mobile joint mechanism to form a mobile joint module with the feature of the second generation mechanical hand as the third degree of freedom for playing the chromatic key. The appearance dimension of this module is as shown in Figure 15.

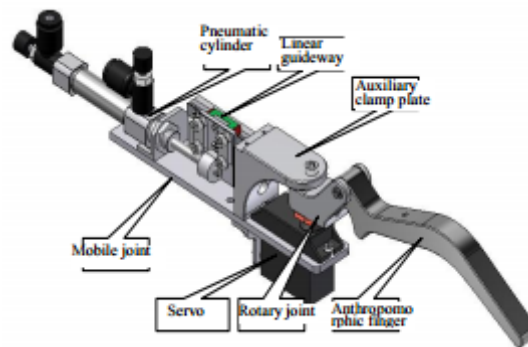

Figure 15. Mobile joint module

The bottom plate of mechanical hand is integrated with the mobile joint module in order to facilitate the action of forward stretching of mobile joint. Therefore there must be guideway at the bottom plate as the junction between the bottom plate and the mobile joint. Here we use the MGN5C guideway of HIWINMIKRO with 70 mm length. The action force is generated by the pneumatic cylinder during the movement. The pneumatic cylinder is designed to be installed at the bottom of mechanical hand where the mobile joint and the axis of pneumatic cylinder are integrated. The moving speed of this mobile joint is controlled by the exhaust throttle valve. The higher speed will lead to larger impact on the mechanical hand, thus this statistic must be adjusted in accordance with the requirement of piano-playing. The dimensions of the design appearance are as shown in Figure 16.

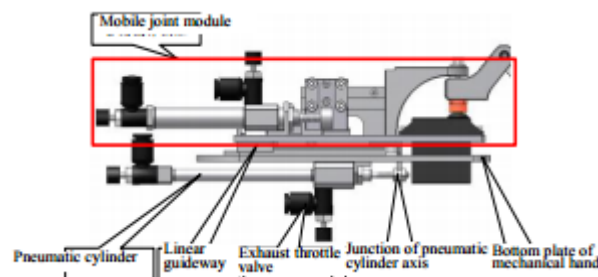

Figure 16. Pressing module

4. ANALYSIS ON THE FINGERS OF MECHANICAL HAND

The R&D of the fingers of mechanical hand has gone through three generations of designs such that the analysis on the fingers are focused on the comparisons among the structural strengths and stresses of these three generations, and the formula calculated from these stress related statistics. The analysis on the fingers through software approach and the results are as shown below.

4.1. Static Analysis of the Fingers

According to the data of output file of ABAQUS/CAE, the maximum stress of mechanical finger takes place at the element near the fixed end. Since in this study we focus all the loads of mechanical hand on

one side, there is going to be a rather significant phenomenon of stress concentration. The yield strength of aluminum alloy material (6061-T6) is at 270MPa with must larger estimated safety factor mainly because of the better processing properties of aluminum and easier access to such material. Thus there is less concern of the stress damage to the mechanical fingers. With the smaller stress on the mechanical fingers, other materials (such as PE material with rapid prototyping approach) with less strength can be used for saving the cost. However, there is another consideration of using aluminum as the material of mechanical hand. During the stage of program testing of mechanical fingers, if the fingers are not completely raised after pressing on the piano keys and the linear motor has started to drive the lateral movement of mechanical hand, the mechanical hand may suffer from lateral impact due to large force generated by the linear motor. This is why we need a high safety factor for the mechanical fingers. The results of analysis on mechanical fingers are described in Table 2 and Table 3. The features of maximum stress and maximum deformation among three generations of mechanical fingers have led to different statistics of increased finger load.

Table 2. Structural stress of the third generation mechanical finger (MPa)

Load (kgf)	0.2	0.4	0.6	0,8	1
Model					
First generation finger	1.215	2.43	3.645	4.861	6.076
Second generation finger	2.068	4.136	6.204	8.273	10.34
Third generation finger	2.122	4.244	6.367	8.489	10.61

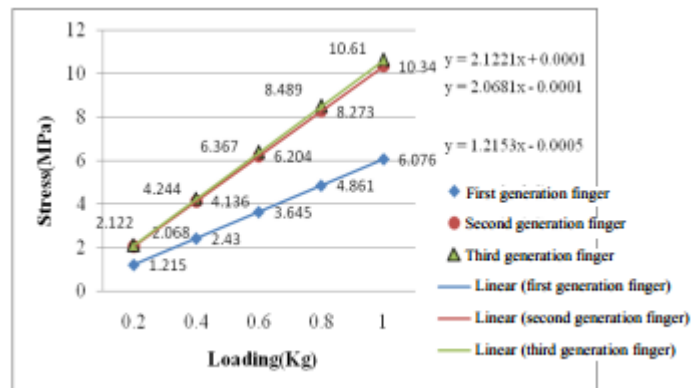

Figure 17. The curves of structure-stress of the first generation, second generation, and third generation fingers

Table 3. The structural deformation of the third generation mechanical fingers (mm)

Load (kgf)	0.2	0.4	0.6	0,8	1
Model					
First generation finger	0.0048	0.0097	0.0146	0.0194	0.02433
Second generation finger	0.0015	0.0308	0.0464	0.0617	0.0778
Third generation finger	0.0015	0.0315	0.0473	0.0631	0.0788

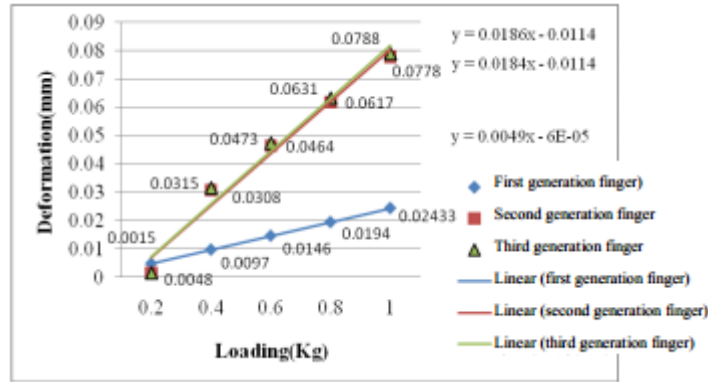

Figure 18. The curves of structure-deformation of the first generation, second generation, and third generation fingers

As for the stress curves and deformations of the second generation and third generation mechanical fingers, there is not much difference between them. However, there is obvious difference between their inner structures. There are weight reduction holes within the third generation fingers to greatly reduce the mass for finger pressing action without losing any strength.

Based on the experimental statistics of structures, stress of each load, and deformations of the first generation, second generation, and third generation mechanical fingers, curves are drawn from all points for solving the trend lines. Six linear straight lines can be obtained from Figure 17 and Figure 18 in order to obtain the estimated structures, stresses corresponding to all loads, and deformation formula corresponding to all loads of mechanical fingers.

Equations 5.1 to 5.3 are the formulas of load and stress of mechanical hand structure, where y is the stress value based on structural analysis, and x is the load (from 0.2kgf to 1kgf). This formula can be used for estimating the stress values of mechanical fingers corresponding to all loads. Equations 5.4 and 5.6 are the formulas of load and deformation of mechanical finger structure, where y is the deformation values based on structure analysis, and x is the load from 0.2kgf to 1kgf. This formula can be used for estimating the value of deformation of mechanical finger structure corresponding to all loads.

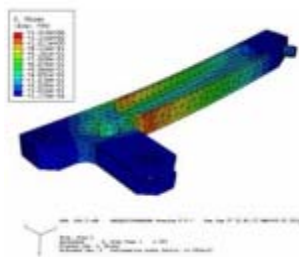

Figure 19. First generation finger-stress diagram

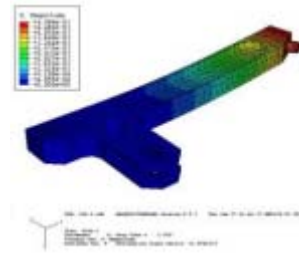

Figure 20. First generation finger-deformation diagram

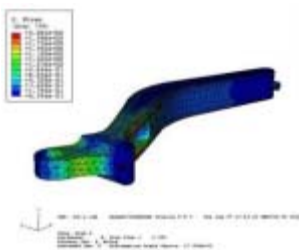

Figure 21. Second generation finger-stress diagram

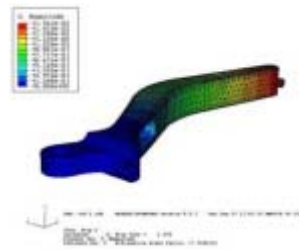

Figure 22. Second generation finger-deformation diagram

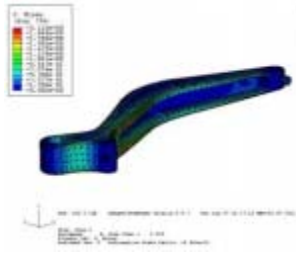

Figure 23. Third generation finger-stress diagram

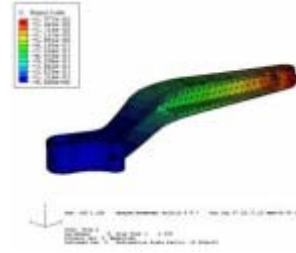

Figure 24. Third generation finger-deformation diagram

ACKNOWLEDGEMENTS

This work was supported by HIWIN Corp. (Project No.100028)

REFERENCES

- [1] TOYOTA Partner Robot <http://www.toyota.co.jp/en/news/04/0311.html>
- [2] TOYOTAViolin-playingRobot http://www.toyota.co.jp/en/news/07/1206_2.html
- [3] Autonomic Limb Control of the Information Processing Robot- Movement control system of robot musician 'WABOT-2'- The International Exposition, Tsukuba, Japan. 1985; JRSJ 3(4): 81-95.
- [4] http://www.humanoid.waseda.ac.jp/booklet/kato_2.html