

Plant Watering Autonomous Mobile Robot

Hema N, Reema Aswani, Monisha Malik

Department of Computer Science Engineering, Jaypee Institute of Information Technology, Noida

Article Info

Article history:

Received Aug 18, 2012

Revised Sep 1, 2012

Accepted Sep 8, 2012

Keyword:

Mobile Robot

RFID

Temperature-Humidity Sensor

Water Pump

Wireless Communication

ABSTRACT

Now days, due to busy routine life, people forget to water their plants. In this paper, we present a completely autonomous and a cost-effective system for watering indoor potted plants placed on an even surface. The system comprises of a mobile robot and a temperature-humidity sensing module. The system is fully adaptive to any environment and takes into account the watering needs of the plants using the temperature-humidity sensing module. The paper describes the hardware architecture of the fully automated watering system which uses wireless communication to communicate between the mobile robot and the sensing module. This gardening robot is completely portable and is equipped with a Radio Frequency Identification (RFID) module, a microcontroller, an on-board water reservoir and an attached water pump. It is capable of sensing the watering needs of the plants, locating them and finally watering them autonomously without any human intervention. Mobilization of the robot to the potted plant is achieved by using a predefined path. For identification, an RFID tag is attached to each potted plant. The paper also discusses the detailed implementation of the system supported with complete circuitry. The paper concludes with the system performance including the analysis of the water carrying capacity and time requirements to water a set of plants.

Copyright © 2012 Institute of Advanced Engineering and Science.
All rights reserved.

Corresponding Author:

Hema N.,

Department of Computer Science Engineering,

Jaypee Institute Of Information Technology,

A-10, Sector-62, Noida 201307, Uttar Pradesh, India.

e-mail: hema.n@jiit.ac.in

1. INTRODUCTION

Plants are a pleasing addition to any house or patio. At the very least, they add color and interesting shapes to a bland room. In the late 1980s, a study by NASA and the Associated Landscape Contractors of America (ALCA) [1] resulted in excellent news for homeowners and office workers everywhere. This study concluded that common decorative houseplants such as bamboo palms, money plant, snake plant, ficus benjamina, Chinese evergreen and spider plants not only make indoor spaces more attractive but also help to purify the air we breathe by absorbing toxins and acting as little oxygen factories. They've also been proven to reduce stress. Plants simply make us feel better by easing mental fatigue and improving air quality. Therefore plants are an indispensable part of our life.

Unfortunately, many plants die each year due to insufficient watering. We've all seen the brown, withered leaves about to fall off. Now a day, due to busy life routine owners either forget to take care of these precious possessions, or they just don't have time to take care about their watering needs. The watering techniques used till date are either, stagnant and not portable or they are very costly. In this case the "Plant Watering Autonomous Mobile Robot" will do the needful by providing a cost-effective solution to this problem.

Moreover today, labor and security are the largest factors. More than 30% of the total production costs are spent on wages of the employees. These are the reasons why already many years ago, research was

focused on the automation of the most tedious and repetitive tasks in horticultural activities and crop production [2]. Moreover, in India the major concern is security. People are reluctant to let workers enter their house due to their personal security in their absence especially in metropolitan cities. The system will act as their personal gardener and will be a boon for the people who love growing plants but cannot manage them due to their busy schedule.

A similar system was developed in May 2003 as a part of Intel Research, “A Robotic Plant Care System” by Kevin Sikorski [3] which watered plants in the Intel Lab. The system used laser range finders to locate pot plants in the lab environment. But the system had several shortcomings. Firstly, the system was not cost-effective, the approximate cost of only the major components of the system like SICK Laser Range Finder, sonar sensors and Pioneer 2-Dxe Robot Base accounted to approximately \$9000 (Prices according to ActiveMedia pricelist June 2002). Moreover, apart from that, the system uses wireless network of Intel Research Lab. Secondly, in spite of using such high cost range finders, the laser range finders failed to work sometimes as the Lab contained surfaces that were hostile to laser reflections e.g. the glass doors. Thirdly, the pot plants were considered to be circles when detected by the range finder, with an assumption that only circular base pots were used, but in real life scenario the shape of the pots can vary from being square to a hexagon to a circular one.

Another system, “PotPet: Pet-like Flowerpot Robot” by Ayumi Kawakami, Koji Tsukada, Keisuke Kambara and Itiro Siio developed in 2011 [4] is a flowerpot-type robot called PotPet. The system enables each plant to physically move autonomously as all plants are placed on the robotic structure equipped with wheels. The PotPet automatically moves to sunny places in search of sunlight. Moreover, it moves around people to grab their attention when in need of water. Plants also express their happiness when watered either by people or rain. But, this system requires each potted plant to be equipped with all the sensors thus increasing the cost of the system with each newly added pot. Secondly, if there are large numbers of pots moving here and there, the people in the vicinity might get disturbed. And finally, the system doesn't actually water the plants; it just grabs their attention and reminds the user to water the plants making the watering operation manual rather than completely autonomous.

Another system with the same purpose is ‘A Smart System for Garden Watering using Wireless Sensor Networks’ by Constantinos Marios Angelopoulos, Sotiris Nikolettseas and Georgios Constantinos Theofanopoulos which was also developed in 2011[5]. This system waters the potted plants by analyzing their soil moisture using sensors and waters them using the attached valves. The problem with this system is that it is not portable; the valves are always attached to the potted plant spoiling the beauty of the environment. Moreover, each potted plant is equipped with separate sensors and valves for watering, which increases the cost of the system as the number of potted plants increase.

Keeping in mind all these parameters, the “Plant Watering Autonomous Mobile Robot” developed by us is a cost-effective, portable, compact and easily maintainable system that will solve the problem of watering plants and will efficiently water the potted plants. It will ease out the work of people as the system is completely autonomous and will prevent the plants from dying by providing timely and adequate amount of water to them.

The next section (Section 2) talks about the working environment of the robot. It describes the System Layout (Figure 2) and the main design constraints and assumptions taken into consideration while developing the system. Section 3 - Materials and Methods, discusses the various hardware components used in the development of the system and the overall working of the autonomous robot. It describes in detail the flow of control along with module wise working and the circuit diagram of the complete system.

Section 4 depicts the results and analysis of the “Plant Watering Autonomous Mobile Robot”; it contains a graphical analysis of the performance of the system and evaluates the time and water requirements on the basis of number of pots. Further, Section 5 and Section 6 focus on the conclusion and end results with the future scope of the system stating the improvements and further additions that can be made to enhance the performance, usability, reliability and efficiency of the system. Figure 1 shows the Architecture of the Autonomous system depicting its complete functionality.

2. THE WORKING ENVIRONMENT OF THE ROBOT

The area to be watered by the Autonomous Mobile Robot can be any field with plants placed in a line along the predefined path which the robot will follow.

The path to be followed by the plant has to be black on white background due to the LDR sensors that absorb light and differentiate between the colors on the basis of amount of light absorbed by them. Each plant has an RFID tag placed on it. The range of the RFID EM-18 Reader Module is about 4 inches. The plant needs to be within 4 inches of the autonomous robot. The RFID tag has to face the RFID Reader Module. The wireless Xbee modules used are configured to interact with each other forming a network.

The system can carry only limited amount of water in one go since the water carrying capacity is one liters due to the weight the DC motors can drive. This also restricts the number of pots and the size of pots to be watered.

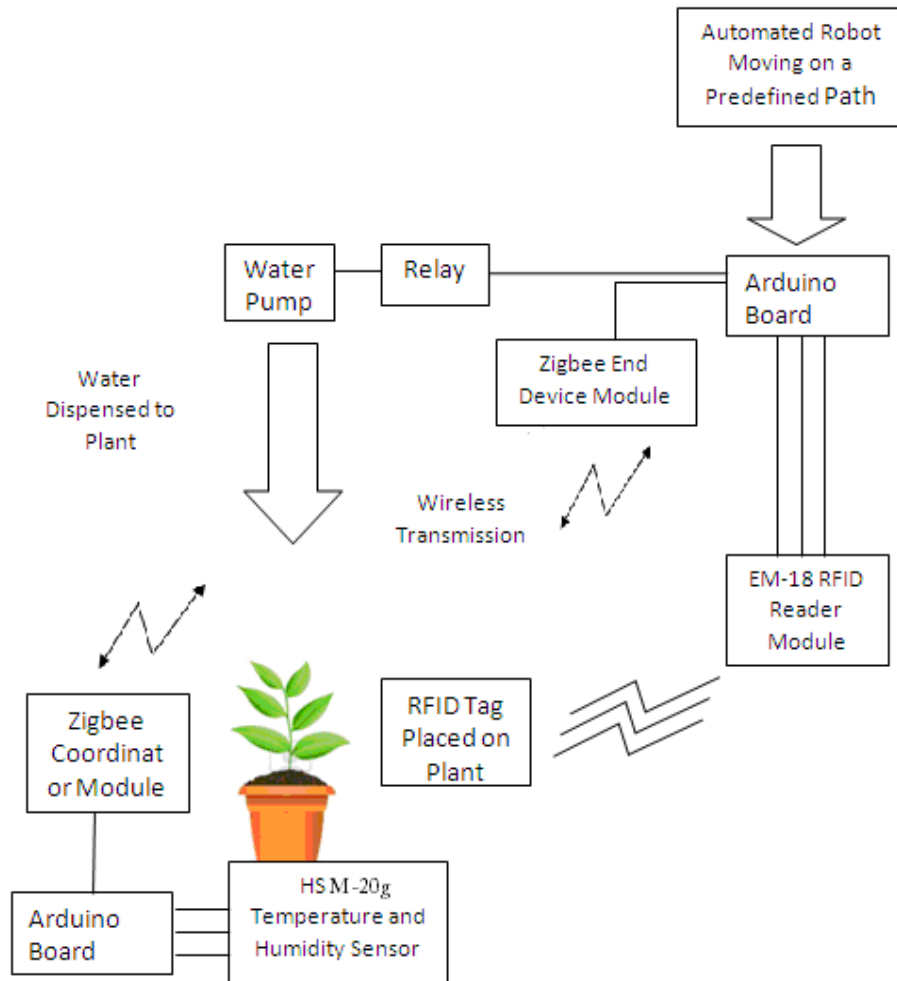

Figure 1. Architecture of the Autonomous System

Since a DC power is supplied to the water pump, the configuration of water pump is taken to be 12V or less. The water pump is triggered using a 6V relay which acts like a switch but instead of physically touching it to switch it on/off we supply voltage to toggle it. For a relay to trigger, an external 9 volt power supply is required.

The temperature and humidity sensor module is to be placed near the plant so that desired values can be obtained for proper functioning of the system.

The height of the potted plant is taken as per the height of the mobile robot so that water can be easily dispensed to the plant using the water pipe.

3. MATERIALS AND METHODS

The Plant Watering autonomous Robot comprises of Arduino Duemilanove controller which has an Atmega AT168 microcontroller that has a pre-installed boot loader, so one can download code to the board using only a USB-serial connection. The code written in Arduino Software can be uploaded to the microcontroller using the A-B USB cable.

Radio Frequency Identification (RFID) Reader Module provides a solution to read passive RFID transponder tags from up to 4 inches away. RFID tags are placed at each potted plant.

Temperature and humidity sensor HSM-20g module is placed on the plant to sense the temperature and humidity values of the plant and analyze its watering needs [6] [7] accordingly. XBee is a wireless communication module that Digi built to the 802.15.4/Zigbee standard. The main feature of the 802.15.4/Zigbee wireless standard is that it can form self-healing mesh networks [8] . It is used to transmit the temperature and humidity of the plant to the mobile vehicle wirelessly. Since we are using a Xbee Series 2, the Outdoor RF line-of-sight range is 120 m and the Indoor/Urban range is 40 m which is quite sufficient for the system developed.

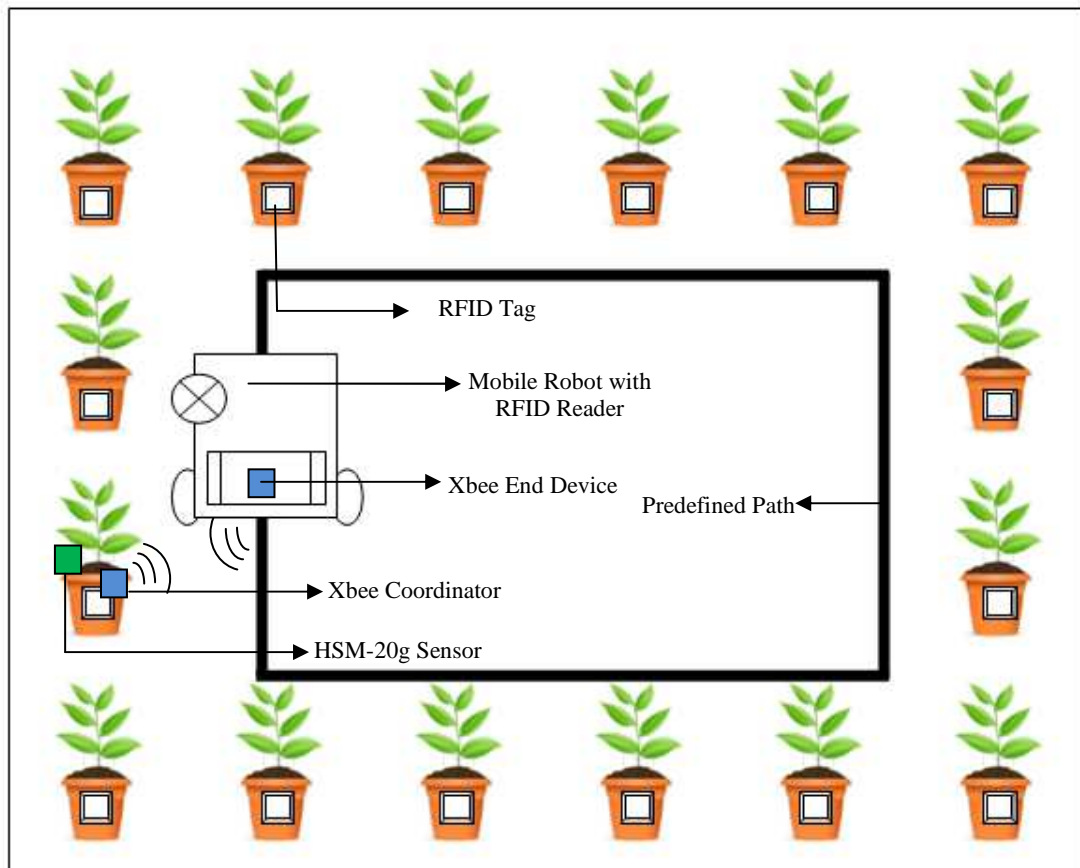

Figure 2. Plant Watering Autonomous Mobile Robot - System Layout

The Plant Watering Autonomous Mobile Robot will follow a predetermined path that will bring it in close proximity to plants. Using an RFID (Radio Frequency Identification)-tag on it, it will detect the nearby potted plant placed within 4 inches. The tag is detected by the RFID reader module EM-18 placed on the mobile robot. The robot senses the plant's temperature and humidity, locates it, waters it [9] and continues on to the next plant.

The plants are placed along the path the autonomous robot will follow. Wireless sensor nodes are placed both on the robot and in the plants being cared for. The temperature and humidity sensor in the plants provide a continuous stream of data reflecting their state while the sensor node on the robot that receives the data acts accordingly .

A small electrical water pump triggered by a relay is used to deliver water from the on-board water reservoir to the plant. Once the robot has watered all the plants it will return back to a specified point at the end of the path in the reverse position so that it can again begin the watering if it senses that the plant is again in need of water. In the case when the water carried by the robot has exhausted it will quit examining the plants and returns back for manual refilling of water in the water reservoir. The detailed description of the system is given below.

- Module 1 comprises of: Zigbee Module [10] (Acting as a transmitter), Arduino Duemilanove board (Microcontroller) and Temperature and humidity sensor (HSM-20g).
- Module 2 comprises of: Zigbee Module (Acting as a receiver), System with robotic wheels carrying water, Two DC Motors with 360 degree rotation, Arduino Duemilanove board (Microcontroller), RFID reader module EM-18, Relay (For triggering the water pump), DC Water pump and a water reservoir.

In the first module, the temperature and humidity sensor module attached at the plant senses the temperature and humidity of the plants in scrutiny. With the help of attached microcontroller i.e. the Arduino board, it determines whether the plant needs water or not. The water requirement is determined using predefined C code uploaded on the Arduino Board using the Arduino Software. The module 1 component provides a continuous stream of data reflecting the state of the plants to be watered, while the sensor node on the robot acts according to the affirmative it gets from the plants. If the plant needs water according to the predefined temperature and humidity threshold settings [11] then a 'Y' is transmitted to the mobile robot using Xbee transmitter placed on the plant to the Xbee Receiver placed on the Module 2 moving robot. If according to the sensed temperature and humidity values and the set threshold, the plant doesn't require water then the Xbee Coordinator sends an 'N' to the sensor node placed on the robot [12]. Figure 3 shows the overview of the system.

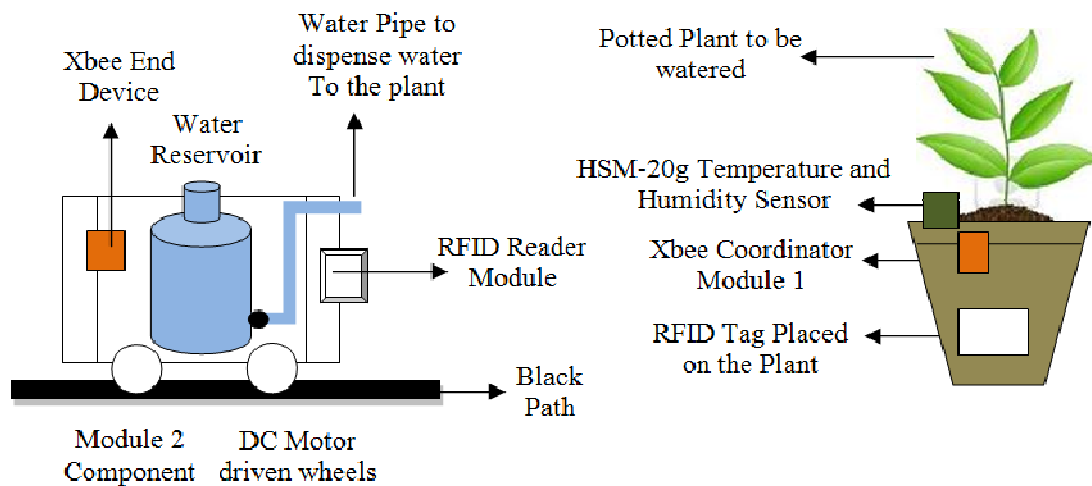

Figure 3. System Overview of plant watering autonomous mobile robot

In the second module, on receiving a 'Y' the system starts moving on the predefined path with the help of LDR sensors placed at the base of the autonomous vehicle. The path is made using a black line which the robot follows till it detects an RFID tag [13]. If an RFID tag is identified by the RFID reader module [14], the robot stops for about 10 seconds to water the detected plant in need of water. As soon as the tag is identified the attached relay is triggered by giving it a high voltage which turns on the attached water pump [15]. This water pump fetches water from the on-board water reservoir of the robot for about 7 seconds and dispenses water to the plant. After the water is completely dispensed to the plant, the autonomous vehicle waits for 3 seconds and then moves again on the path to continue watering the rest of the plants. Thus, in this way this Plant Watering Autonomous Mobile Robot waters each plant that comes on the way.

The control flow diagram in Figure 3 summarizes the working of the Plant Watering Autonomous Mobile Robot. The Figure 5 shows circuit diagram that has been implemented for the Plant Watering Autonomous Robot. Since the plants are placed in a square field in a small area, the temperature of each plant is assumed to be the same and thus only one temperature and humidity sensor module is placed and all plants are watered according to the values sensed by that sensor.

In case of a huge area spread in kilometres, there will be a need for more than one temperature and humidity sensor to be placed. The capacity of the on-board water reservoir is taken to be one litre while performing the experiment. The RFID Reader Module is mounted along the left side of the autonomous mobile robot. By placing one more RFID Module to the right side, the efficiency of the system can be improved as now the system will be able to water the plants coming on both sides simultaneously. It will not have to take another round for the plants placed on its right side. This will reduce the time required by the system considerably.

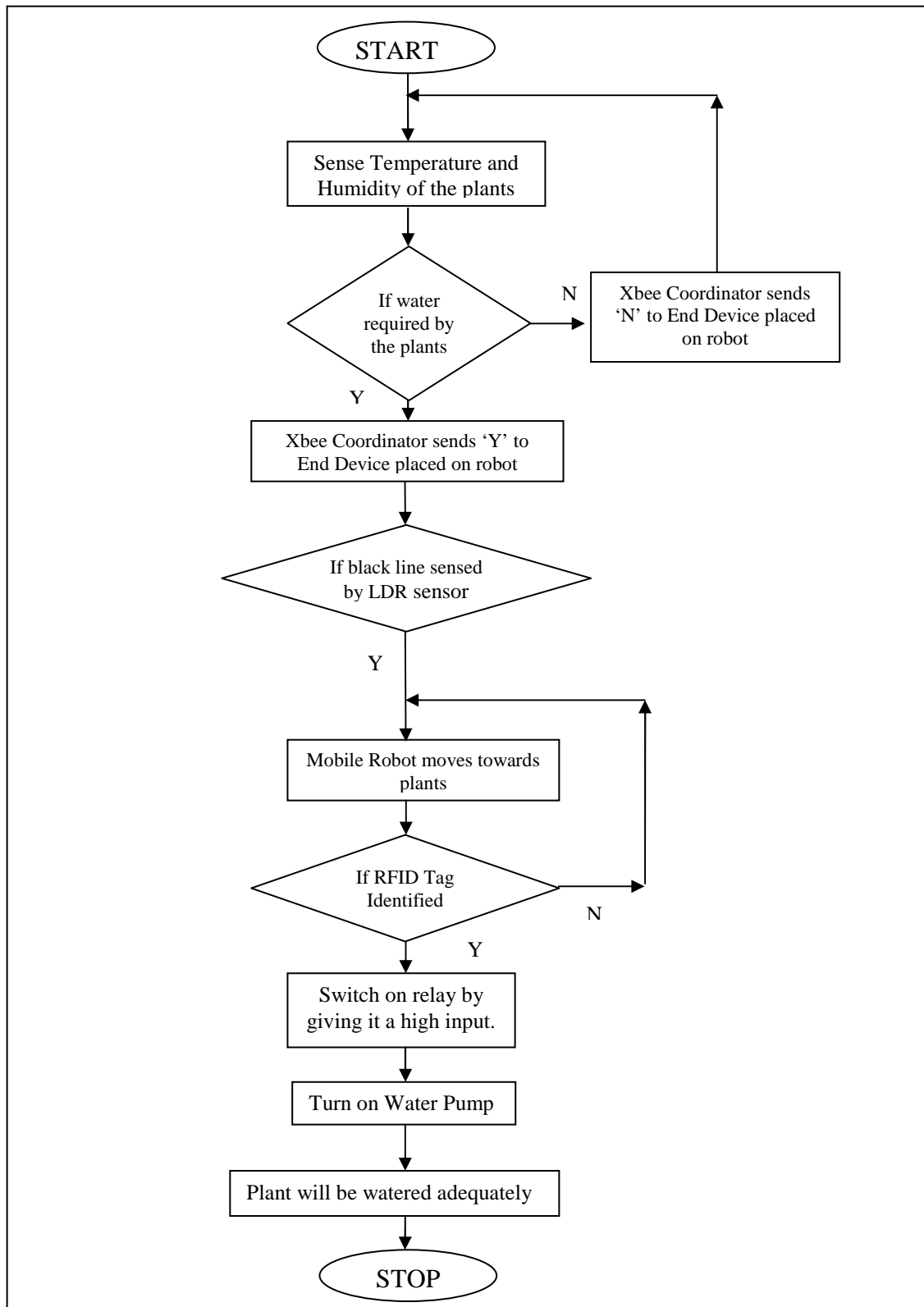

Figure 4. Control Flow Diagram of the System

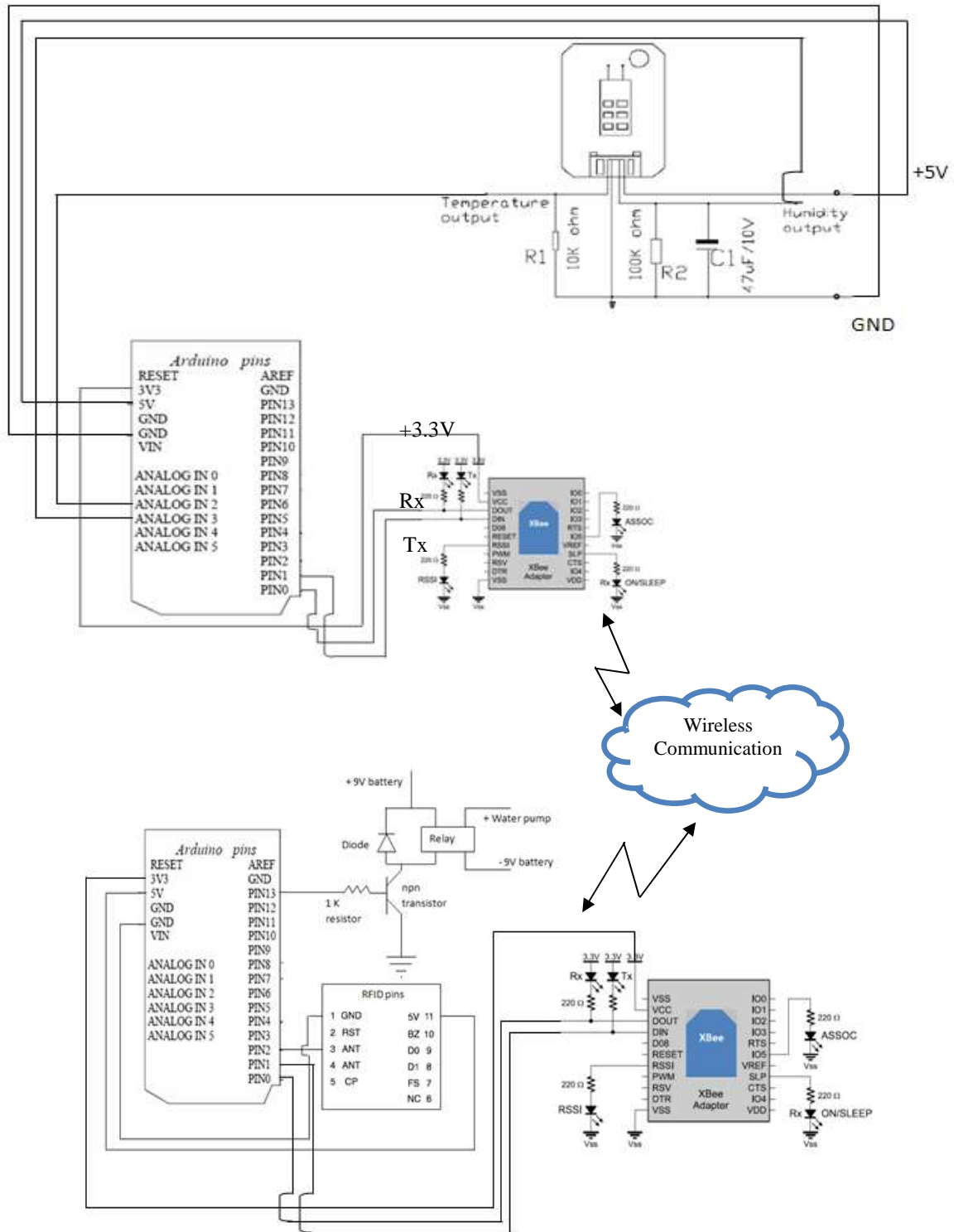

Figure 5. Circuit diagram of Plant Watering Autonomous System

4. RESULTS AND ANALYSIS

The Plant Watering Autonomous Mobile Robot is designed keeping in mind all the shortcomings of all the existing systems.

On comparison with the already existing systems for watering the plants indoors, as discussed in the introduction section, our system design emerged out to be efficient in terms of portability when compared

with the 'A Smart System for Garden Watering using Wireless Sensor Networks', as the above mentioned system is stagnant and valves are attached for watering the plants which lay all around the plants spoiling their natural beauty,

User ease and maintainability were the areas where our design proved to be better when compared with the system 'PotPet: Pet-like Flowerpot Robot' as the PotPet system doesn't actually water the plants, it just alarms the user to water the plants manually. The system is also not easily maintainable as the plants when large in number roaming here and there are difficult to manage unlike the design proposed in this paper where there is just one completely autonomous robot, following a predefined path without disturbing the people nearby.

And finally it has an edge in terms of cost effectiveness when compared with the 'A Robotic PlantCare System' by Intel which is discussed in detail in the next section. The Figure 6 below shows the System snapshot of the Plant Watering Autonomous Mobile Robot:

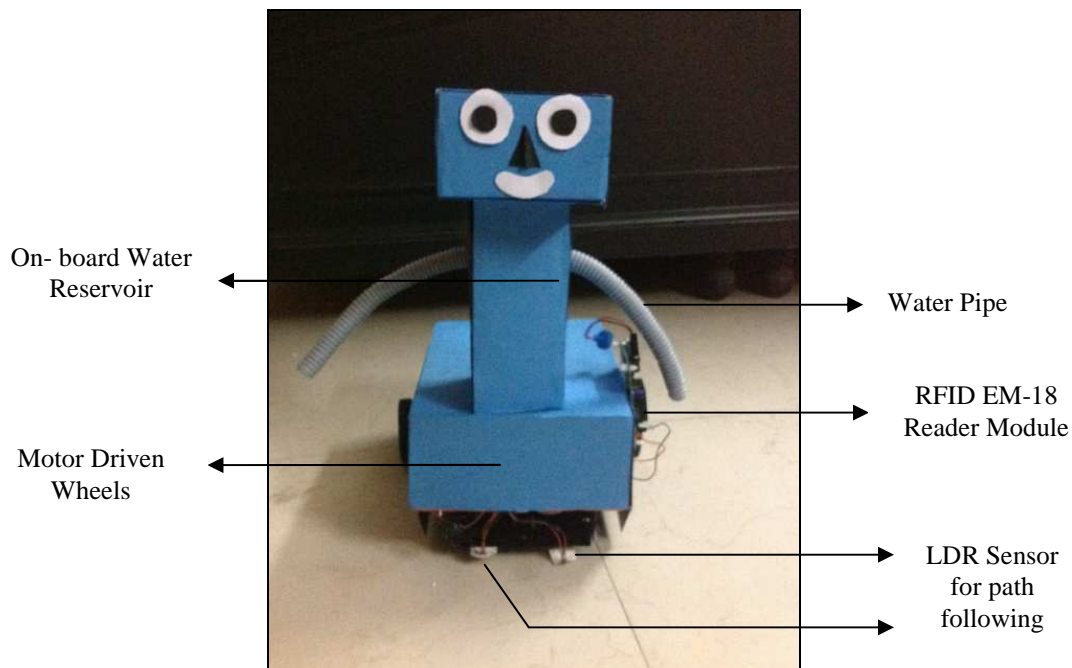

Figure 6. System Snapshot

Table 1. Cost Analysis of existing automated pant watering system

Intel Research PlantCare System* (Major Components)			Plant Watering Autonomous Mobile Robot		
COMPONENT	QTY	COST**	COMPONENT	QTY	COST
SICK Laser Range Finder	1	\$5000	Arduino Duemilanove	3	Rs 1600
Pioneer 2-Dxe Robot Base	1	\$3995	RFID EM-18 Reader Module	1	Rs 800
Lead-Acid batteries	3	\$68.44	DC Motors	2	Rs 300
Sonar Sensor	8	\$236	Relay	1	Rs 50
			Xbee Module	2	Rs 5000
			Temperature and humidity sensor HSM-20g	1	Rs 800
			Water Pump	1	Rs 250
			LDR Sensor	2	Rs 50
Total Cost (Approx)		\$9299.44	Total Cost		Rs 8850 (\$160)***

*Apart from this it uses the wireless network of Intel Research Lab.

**Prices as per ActiveMedia pricelist June 2002

*** According to the conversion of Rupees to Dollar (1\$=Rs 56)

4.1 Cost Analysis

On comparison with the already existing system developed by the Intel Research Lab, “A Robotic PlantCare System”, our design of the Plant Watering Autonomous Mobile Robot emerged out to be very cost-effective. Shown below is the cost analysis of both the systems stated with the distribution of cost for different sensors and equipments used.

The difference in cost of building the system is huge and Plant Watering Autonomous Mobile Robot is almost 50 times more cost-effective.

4.2 Performance and Evaluation

The autonomous vehicle uses DC motors with rpm (rotation per minute) of 180. Once an RFID tag is detected, on average the system needs 10 seconds to water the potted plant. After another 3 seconds, it continues further on the path towards rest of the plants coming on the way. If in total 50 plants are placed on a equal distance of 20 centimeters, then approximate time needed is $((180*10*50)/60) + (3*50) + (9*49) = 2001$ seconds = 33.35 minutes. The water carrying capacity of such a system will be $400*50 = 20000$ milliliters.

Corresponding is a relationship between no. of pots and time:

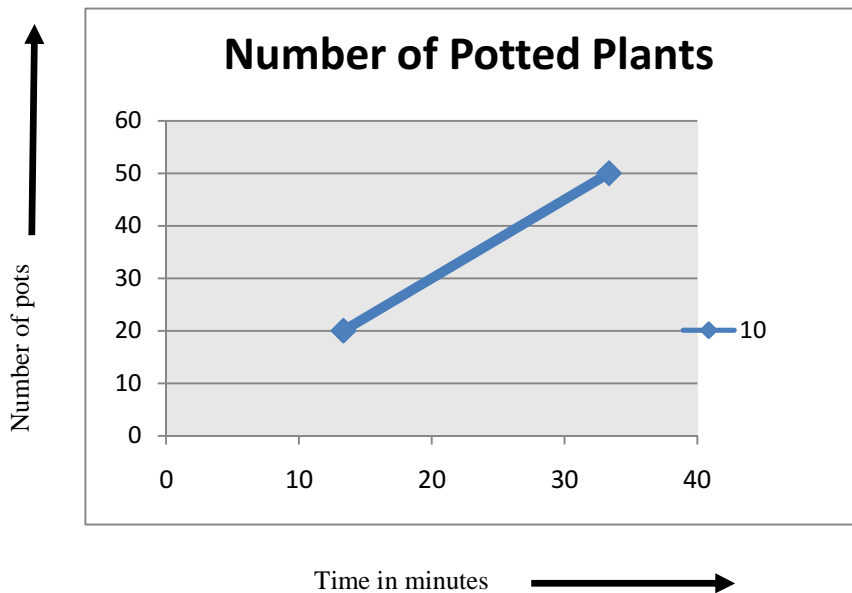

Figure 7. Analysis of time and water requirements according to the number of pots

The table 2 depicts the calculations for the number of pots, the time taken by the robot to water those plants and the total amount of water required in milliliters to perform the watering operation. Distance between each pot is 20 centimeters.

Table 2. Calculations showing timing and water requirement for different numbers of pots.

No. of pots	Time (in minutes)	Water (milliliters)
10	6.67	4000
20	13.34	8000
50	33.35	20000

5. CONCLUSION

In this paper, we presented a completely autonomous system which helps in watering indoor potted plants that are arranged along a predefined path. The mobile robot is capable of performing three main functions of sensing the watering needs of the plants in need of water, locating them and finally watering them autonomously without any human intervention. The system comprises of the autonomous vehicle,

Arduino microcontroller, the RFID reader module, the water pump, the relay, temperature and humidity sensor (HSM-20g), and the Xbee device for wireless communication. The performance of the individual components has been assessed in the laboratory by various experiments.

The calculations for the number of pots watered, time required by the system to water the selected set and the water required in milliliters have been depicted. The System performance had been evaluated by plotting a graph between the number of plants watered and the time required by the mobile robot to perform the watering operation indicating that the system is not only cost-effective but also efficient in terms of time.

6. FUTURE WORK

In future, we plan to use solar panels along with rechargeable batteries instead of 9V batteries in order to make our system efficient, reliable and self sustainable in terms of energy consumption. We also plan to incorporate to our system the ability to be managed remotely. This will be done by allowing to access and control the system with the use of web-services (e.g. via Android smart-phones).

Plant detection can be done by using a wireless Web Camera instead of RFID tag. This will reduce the cost of the system considerably. Moreover, the same can be used for path planning and obstacle avoidance for the mobile robot.

Furthermore, the plant water requirements can also be analyzed by extracting the present day temperature and other required values by remote sensing of satellite data.

REFERENCES

- [1] B.C. Wolverton, Anne Johnson, and Keith Bounds, "Interior Landscape Plants for Indoor Air Pollution Abatement: Final Report", *National Aeronautics and Space Administration (NASA-TM-101768) Science and Technology Laboratory, Stennis Space Center*, 1989.
- [2] E.J. Van Henten, J. Hemming, B.A.J. Van Tuijl, J.G. Kornet, J. Meuleman, J. Bontsema and E.A. Van Os; "An Autonomous Robot for Harvesting Cucumbers in Greenhouses"; *Autonomous Robots*; Volume 13 Issue 3, November 2002.
- [3] Kevin Sikorski, "Thesis- A Robotic PlantCare System", *University of Washington, Intel Research*, 2003.
- [4] Ayumi Kawakami, Koji Tsukada, Keisuke Kambara and Itiro Siio, "PotPet: Pet-like Flowerpot Robot", *Tangible and Embedded Interaction 2011*, Pages 263-264 ACM New York, NY, USA, 2011.
- [5] Constantinos Marios Angelopoulos, Sotiris Nikolettseas, Georgios Constantinos Theofanopoulos, "A Smart System for Garden Watering using Wireless Sensor Networks", *MobiWac '11 Proceedings of the 9th ACM international symposium on Mobility management and wireless access* Pages 167-170 ACM New York, NY, USA, 2011.
- [6] T.C.Manjunath, Ph.D. (IIT Bombay) & Fellow IETE, Ashok Kusagur , Shruthi Sanjay, Saritha Sindushree, C. Ardil, "Design, Development & Implementation of a Temperature Sensor using Zigbee Concepts", *International Journal of Electrical and Computer Engineering 3:12 2008*.
- [7] Rafael Muñoz-Carpena and Michael D. Dukes, "Automatic Irrigation Based on Soil Moisture for Vegetable Crops", *Applied Engineering in Agriculture (2005)*.
- [8] Christos Tatsiopoulou and Aphrodite Ktena, "A Smart ZIGBEE Based Wireless Sensor Meter System", *IEEE Electrical Engineering (2009)*, ISBN: 9781424445301,2009
- [9] Ragheid Atta, Tahar Boutraa and Abdellah Akhkha, "Smart Irrigation System for Wheat in Saudi Arabia Using Wireless Sensors Network Technology", *International Journal of Water Resources and Arid Environments 1(6): 478-482, 2011, ISSN 2079-7079, © PSIPW, 2011*.
- [10] Manual by Martin Hebel and George Bricker , " Getting Started with XBee RF Modules: A Tutorial for BASIC Stamp and Propeller Microcontrollers", Version 1.0, ISBN 9781928982562.
- [11] UC Hobby, "Visualizing sensor data with Arduino processing", <http://www.uchobby.com/index.php/2009/03/08/visualizing-sensor-with-arduino-and-processing/>.
- [12] "XBEE Tutorial", <https://sites.google.com/site/xbeetutorial/example>
- [13] "RFID card reading", <http://www.jeremyblum.com/2011/07/08/tutorial-12-for-arduino-rfid-card-reading/>.
- [14] "Connection of RFID and Arduino board", <http://www.instructables.com/id/Arduino-and-RFID-from-seedstudio/>.
- [15] Hobby Robotics, "Using Relay with Arduino", <http://www.glacialwanderer.com/hobbyrobotics/>.

BIOGRAPHIES OF AUTHORS

Hema N is senior lecturer in Computer Science and Engineering Department at Jaypee Institute of Information Technology, Noida, India. She has more than 10 years of teaching experiences in area of Microprocessor, Microcontroller, Automation and Embedded Systems. Her research interests include Autonomous System, Mobile Robots, Automation of Precision Farming and Automation of Precision Irrigation using Wireless Sensors Networks.



Reema Aswani is currently pursuing M. Tech from Jaypee Institute of Information Technology, Noida, Uttar Pradesh. She has been working in the field of Embedded Systems for more than a year. Her interest includes Autonomous Systems, Mobile Robots and Embedded System.



Monisha Malik is currently pursuing M. Tech from Jaypee Institute of Information Technology, Noida, Uttar Pradesh. She has been working in the field of Embedded Systems for more than a year. Her interest area is Autonomous system and Embedded System.