

ONLINE TEST USING DESIGN BANANA PI AND LOCAL NETWORK

Brian Rakhmat Aji

Department of Informatics Engineering
State Islamic University Sunan Kalijaga
Yogyakarta, Indonesia
brianetlab@gmail.com

Abstract- At this time the exam using paper rated less cumbersome and inefficient. In this case the teacher will make difficult to assess the answers and take a long time to finish the job. In developing this system, the author is still in the development stage by using Banana Pi sebgai server, and use a router to a local network, this system is expected to facilitate the teacher to correct the test results.

This test system uses CodeIgniter framework as a backend and frontend using material design. The system is easy to use and portable for a local network to connect them.

Keywords: Online Exam System, Banana Pi, Router



I. INTRODUCTION

Currently, there are still some schools when the schedule for the exam using paper manually, but the school has adequate computer facilitation. Assessment manual for correct test result is not very effective if there is a lot of exam questions that need to be corrected. Things like this becomes an obstacle for the teacher to correct the test result manually. This test system uses the concept of CBT (Computer Based Test) which use Computer Server and the Client Computer.

Online examination system is one alternative to facilitate the examination process without requiring a paper medium and long correction process. The system is built based website that can be accessed by many people and is not constrained to be at the same time. In addition the system can reduce the level of cheating the students for each question can at random between one student to another.

Banana pi is a mini PC that has a processor, RAM, and a hardware port that can be used as a server. The operation system using Debian. Some of the advantages is that it can be used as a portable server and requires little power only to the power bank can live Banana Pi. Application of Banana Pi online examination system is expected to be able to facilitate and improve the quality of education and teaching, especially in Indonesia.

II. PURPOSE

The purpose of this study was to develop an online exam system has advantages:

(1) Do not need an internet connection and a big power, (2) Characteristically portable because the server is sufficiently inserted into the small box packaging, (3) A student can take a test to be honest because the system will randomize question (4) The teacher can see and correct the exam results students easily so that you have time for other activities.

III. METHODOLOGY

A. materials

In making this application in the analysis of Non-Functional Requirements, as for the needs of Non-Functional owned among others Needs Hardware and Software Requirements:

1) Hardware

- Laptop: Laptop used to create applications and everything to configure the application. Laptop Specifications:
 - Intel Core i5 Processor
 - 4GB DDR3 RAM
 - SSD 120 GB and 500GB hard drive

- Internet Connection: Used to search for survivors refrensi application creation
- Banana Pi: The main device in the manufacture of this system, this device will be used as a server.
- Router: As a liaison between Banana Pi (Server) and User (Client)
- Micro SD: As storage Operat System and Online Exam System.
- Micro USB Cable: As powersupply for Banana Pi
- Banana Pi Casing

2) Software

- Visual Studio Code: Open Source IDE for Coding Development
- Debian OS: Operating system for Banana Pi
- Putty: SSH for Server and Client

B. Literature review

Data collection techniques by conducting a review of the book, literature, records, and reports dealing with the problem to be solved. [1]

C. System planning

According to Bentley and Whitten [2] through a book called "system analysis and design for the global enterprise" also explains that the design of the system is complete the problem-solving techniques with small components into a unitary system components back into a complete system. This technique is expected to result in a better system.

D. System Development

After a literature-based analysis, system design that had previously been done the next step is to assemble the entire system making components.

E. System Testing

At this stage testing of the system have been made. Once the code is created, the test program is started. The test focuses on the internal logic of the software and on the external functional, ie direct testing to find errors - errors and ensure that the limited input will provide actual results that correspond to the required result. At this stage also conducted testing for the operation that led to the readiness to implement.

F. Maintenance System

If the system test phase is completed, it is time for system maintenance. Maintenance includes hardware maintenance and software maintenance. Often times when a system has been created and is only used alone but there was never any



maintenance. Maintenance of the system is intended to avoid minor bugs that would disrupt the system.

IV. RESULT & DISCUSSION

A. System Development

Application development consists of two parts, namely the development of hardware and software development. Hardware development focused merangkat Banana Pi Pi to Casing and routers, and software development makes applications with CodeIgniter Online Examination System based websites.

1) Hardware Development

In developing hardware using Banana Pi and Router.

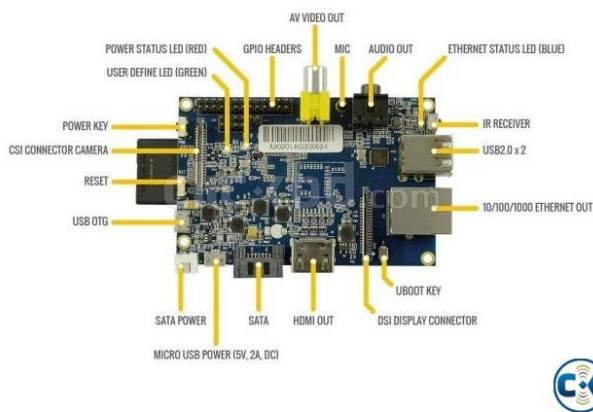

Figure 1. DFD Level Context Diagram



Figure 2. DFD Level Context Diagram

2) Software Development

In developing the software there are several steps which are:

a) Web Based Application Development

Using a web-based application to access the exam, the application site is considered more practical than the Desktop and Android-based applications because there is no need to install it first. The author uses CodeIgniter and using materializecss to zoom.

DFD Level Context Diagram

b) Design DFD

Context diagram is a depiction of an outline of an online exam system was created and shows the relationship between users who are directly involved with the system

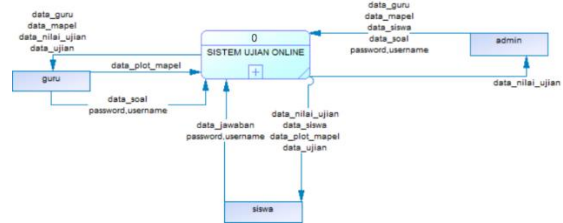

Figure 3. DFD Level Context Diagram

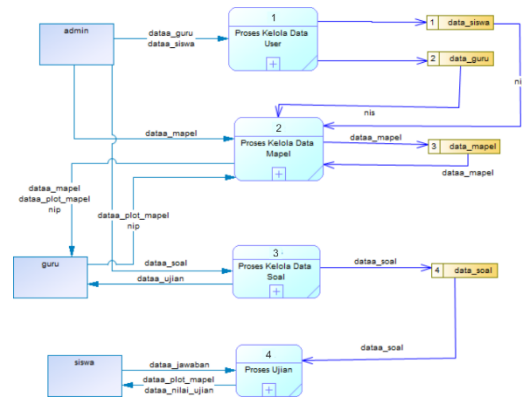

Figure 4. Diagram DFD Level 1

c) Design ERD

Draft ERD Online Testing System as follows:

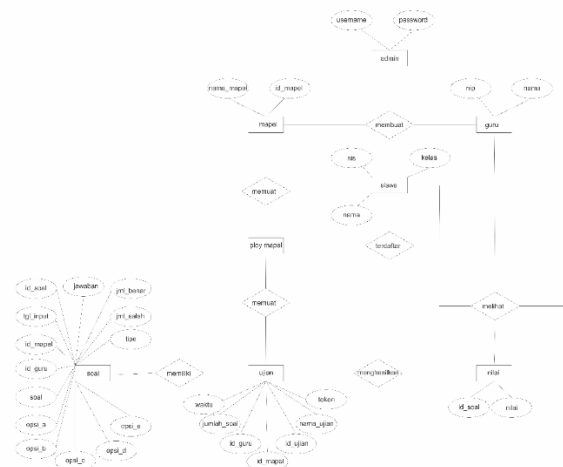

Figure 5. ERD Online Testing System

d) Relation Database Design



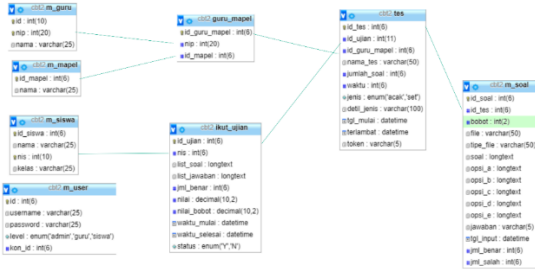

Figure 6. Design of Online Testing System ERD

e) Network Development

Manage Wireless Networks. The wireless network will be used as a link between Banana Pi as a Server and Laptop. Therefore the network is set IP Address.

B. System Implementation

In this section discusses the implementation of Online Exam System. In this system the user is divided into 3 administrators, teachers, and students. The difference between the third user is, CRUD admin work section in the user data (teachers and students), and the data about the data subject. Part of teachers working part CRUD data on and make the exam. While the students can only take the exam only.

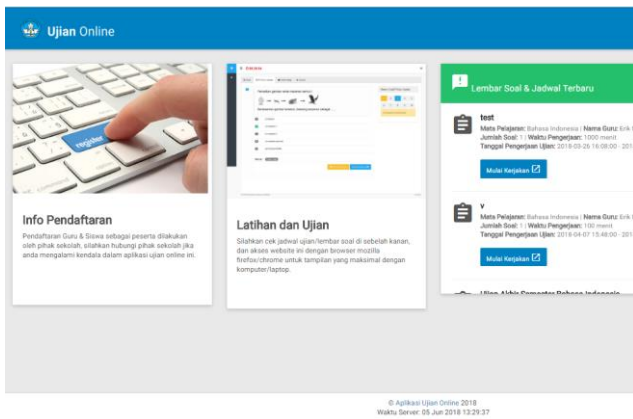

Figure 7. Display System Implementation

1) The login page

Users can login on this page with the password and the username alone.

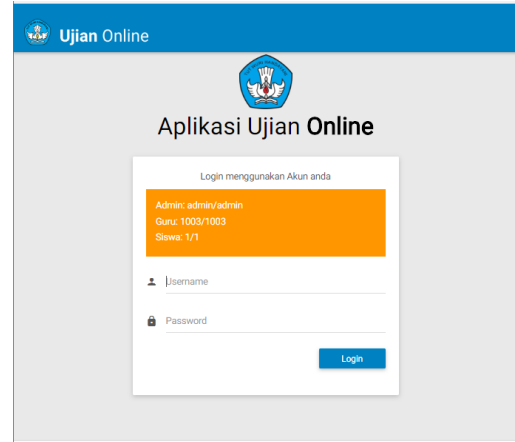

Figure 8. Login Page Views

2) Admin page

Admin will be tasked with managing the user data (students and teachers), the data mapel, and data on student test results.

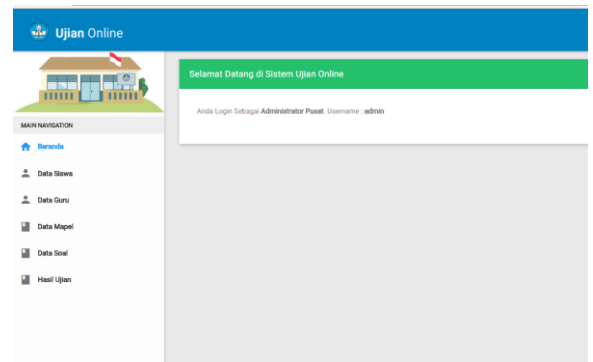

Figure 9. Admin Page Views

3) Admin page Student Data

Admin can manage user data (teachers and students) as add, edit, delete, enable the user, downloading user data and user data import.

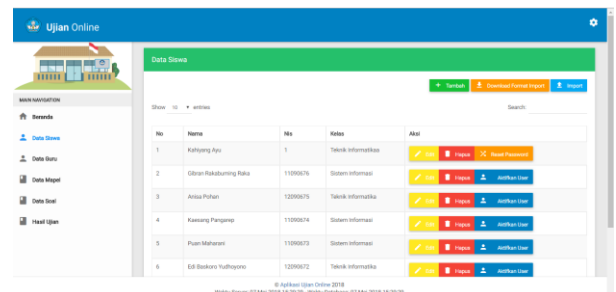

Figure 10. Student Data Admin Page Views

4) Admin page Data Problem



On this page admin can manage the data subject as mmenambah, edit and delete data.

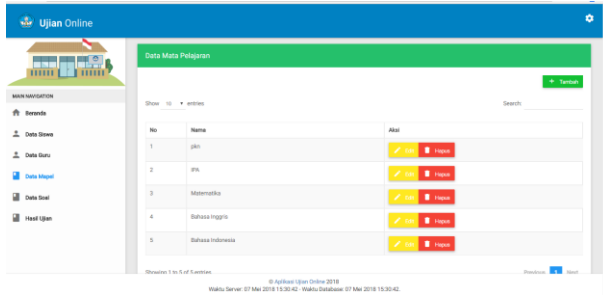

Figure 11. Data Admin Page Views Mapel

5) Admin page Data Problem

On this page admin can manage data about such as add, edit, delete, download, import and print matter.

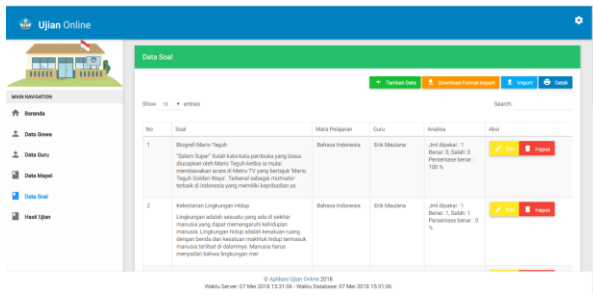

Figure 12. Admin Page Views Data Problem

6) Admin page Exam Results

Admin can see all of the test data that has been done.

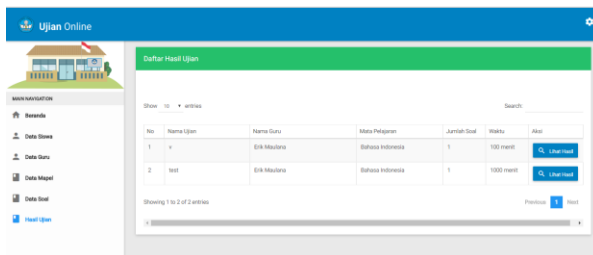

Figure 13. Admin Page Views Exam Results

7) Test Data Details page

Admin can view and print detailed test data.

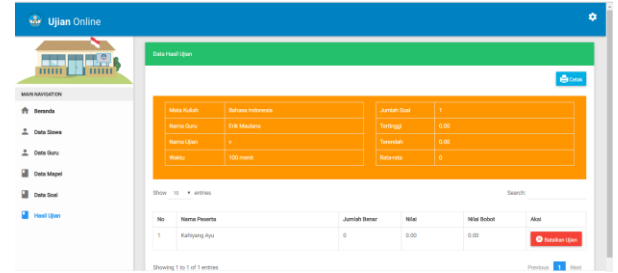

Figure 14. Test Data Detail Page Views

8) Students Start page Exam

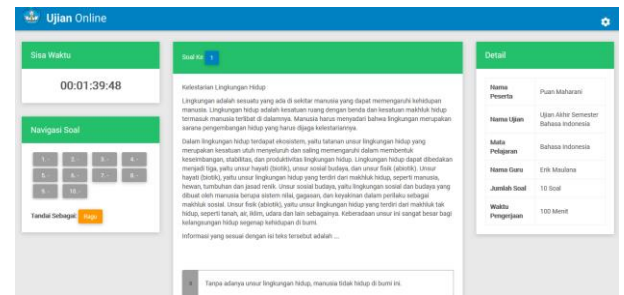

Figure 15. Exam Students Start Page Views

9) Students page View Exam Results

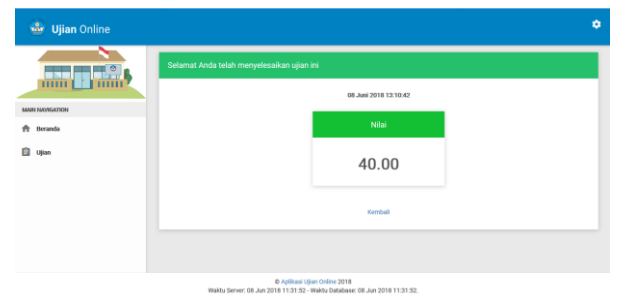

Figure 16. Pageviews Student View Exam Results

C. System Testing

The testing of the computer based test systems is divided into two parts. The first part is hardware testing the which includes the Banana Pi and Router.

Together with this, the second part is testing software that includes Banana Pi software testing and web-based Computer Based Test. It aims to find out the software and hardware that has been made that is suitable for the purpose of the software and hardware development.

TABLE I. SYSTEM TESTING

| No. | Testing Item | Detailed Testing | Type of Test |
|-----|--------------|------------------|--------------|
|-----|--------------|------------------|--------------|



| | | | |
|---|---------|--------------------------------------|-----------|
| 1 | system | Sytem is Able to process online test | Black Box |
| 2 | Display | System can display online test score | Black Box |

V. CONCLUSION

Based on experimentation that have been accomplished during the Development of System Online test Using Banana Pi and routers, it can be Obtained as follows: (1) Banana Pi can use for servers, (2) The program can work properly with another browser type, (3) The Student can access the System Online test what you want when ever and where ever what you want during avaiability wireless signal, (4) The Teacher can monitor the result of student test or examination.

ACKNOWLEDGMENT

Thankyou for Dr. Bambang Sugiantoro, MT as a lecturer for guiding me so that I can finished this paper and thank you for CV Berkah Abadi so that I can Intership and until finished this project..

VI. REFERENCES

- [1] Nazir, 1988.
- [2] Bentley and Whitten, 2009 : 160.
- [3] Abdi Mirzaqon and Budi Purwoko, "Library Research Of the Basic Theory And Practice Of Expressive Writing Counseling," p. 4.
- [4] Lonnie D. Bentley and Jeffrey L. Whitten, System Analysis and Design for the Global Enterprise.
- [5] Susi Susilawati and Taufik Hidayat, "Design of Online Testing Information System," *Case Study at SMAN 58 Jakarta*, vol. 4, no. 1, 2018.
- [6] A. Nugroho, Object Based Software Engineering Method USDP, Yogyakarta, 2011.
- [7] Tantra, R, Project Management Information System, Yogyakarta: Andi, 2012.
- [8] Karishma S & MR Vargantwar, "Raspberry Pi Based Online Examination System," vol. 5, no. 9, 2016.

