

Topology Analysis of iBGP Confederation

Case : Indonesia Research and Education Network (IdREN)

Irwin Wijaya Lahusen¹, Widyawan², Sri Suning Kusumawardani³

Department of Electrical and Information Engineering
Gadjah Mada University
Indonesia

¹irwin.w@mail.ugm.ac.id, ²widyawan@ugm.ac.id, ³suning@ugm.ac.id

Abstract—Implementation of the BGP Confederation topology scenario, found a number of new facts that influence the final decision making for BGP network managers. In previous studies it has been mentioned a number of factors that influence QoS from a topology scheme, among others, the number of Sub AS and the number of routers that make up the iBGP topology. In this study, a number of scenarios were developed by giving variants to bandwidth parameters and adding measurement parameters to Lost Datagram in all scenarios. The results obtained are quite significant, affecting QoS and finding a number of new facts related to the effect of using traffic generators. This research was tested on the Indonesia Research and Education Network (IdREN) network using GNS3.

Keywords—IdREN; NREN; iBGP; BGP Confederation; QoS

I. INTRODUCTION

The Internal Border Gateway Protocol (iBGP) is a subpart of a BGP network on the internal side of the AS (Autonomous System). iBGP can be compiled from dozens of routers and even thousands of routers depending on the size of the network being managed. The larger the iBGP network, the more complex the administrator faces. There are three methods used in managing networks in iBGP, namely full mesh, route reflector and BGP Confederation.

The research conducted by [1] has tested 3 scenarios in the iBGP network with the BGP Confederation method, namely scenario 2 Sub AS, 3 Sub AS and 6 Sub AS, with the conclusion that scenario 2 Sub AS is superior to other scenarios based on 3 parameters, Delay, Output, and jitter . The research has used UDP data types and 100 Mbps set bandwidth [1]. This study will further analyze the research by adding the lost datagram parameter and by adding a bandwidth set of 2 Mbps.

In the data communication through the Internet, routing is something that is vital for a well-managed in order to improve the performance of the network itself. Routing and routing dynamics are essential for obtaining fast updating addresses between routing devices themselves.

IdREN network functions to connect academics from various institutions and universities. IdREN is run with the BGP protocol, so that it runs normally according to its function. In its implementation IdREN runs a standard topology scheme of BGP, Internal BGP (iBGP) and External BGP (eBGP), with a full-mesh method in its iBGP. Internal BGP (iBGP) has been known to have three methods namely Full Mesh, Route Reflector, and BGP Confederation, where it is known that all have advantages and disadvantages.

The need for a network with handling capabilities of Quality Services (QoS) in the form of throughput delay, jitter and lost datagram, are not only needed by the main universities that are the initiators of IdREN, but by all universities, both those who have joined or are still in the interconnection stage. The method in iBGP IdREN currently in use, is still widely open for improvement. In this study, a number of Sub AS scenarios from iBGP IdREN will be demonstrated using the BGP onfederation method. BGP Confederation as a routing method in iBGP, uses the method of grouping in handling routing. BGP Confederation was formed by breaking up the iBGP network into small groups called Sub AS. iBGP IdREN with 6 routers can be formed 3 combinations of Sub AS using the BGP Confederation method. These three combinations are formed with consider the balance of the composition of routers in each Sub AS. The topology that is formed will then be flowed by data traffic using the traffic generator. The number of combinations that can be obtained from each Sub AS varies according to the number of routers per Sub AS. To simplify research, one is chosen the combination with the farthest hop in each Sub AS scenario as a representation of the scenario.

IdREN members scattered with geography in the form of islands in the country of Indonesia and the use of multi service providers require topology scheme recommendations that are

appropriate for the implementation of BGP Confederation on IdREN. With this research, it is expected that the best scenario recommendations can be obtained according to the needs of IdREN members. The scenarios tested in this study were then analyzed to determine the effect of the topology scheme on the BGP Confederation method on increasing QoS from the IdREN network.

A. IdREN

IdREN is the development of Indonesia Higher Education Network (INHERENT) which has been operated since September 2015[2]. Today, it connects 55 Higher Educations and 32 others on the queue of physical connection[3].

At the founding age of IdREN by using AS Number AS18007 as its prior one, INHERENT, but then in 2016 it changed to use AS64302 [4].and consist of 5 node border gateway on each University such as in UI, UGM, ITB, ITS and UB, also node border on Internet Provider , that is Telkom [5].



Figure 1. IdREN Gates and Nodes [6]

As part of Research and Education Network (REN) global network, IdREN is connected to global REN through TEIN4 (AS24490) with 1 Gbps bandwidth, where national gate is in ITB IdREN [5], [7].

IdREN plan development forward will apply multihomed system, It will has several providers to participate in serving IdREN members [8]. By this development, the spread of bandwidth and topology scheme of IdREN will be important one to discuss further.

IdREN nowadays is getting widely spread and mostly related to the research implementation on networks such as Network test Bed / SDN; Weather prediction Model / Disaster mitigation (Flood and fire); Telemedicine (TEMDEC); E-learning; Lapak IdREN; e-Village; RIPE Atlas; and Cloud and ID Federation [5].



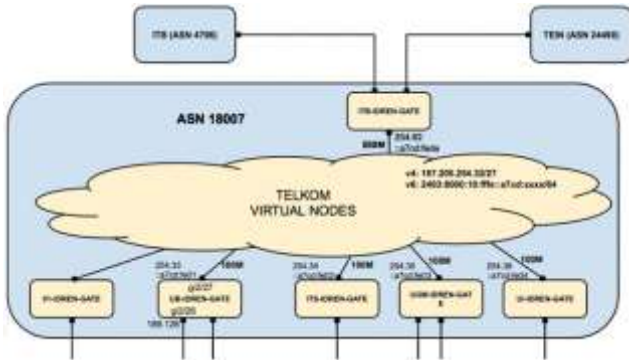

Figure 2. IdREN Link to Global REN [5]

B. BGP Confederation

By considering IdREN in the future which the long queue among Universities and geographical location in Indonesia, the form of iBGP topology and IdREN node border location take them important issues.

Research on IdREN topology is also important to decide any University joining its best suit in a such of provider.

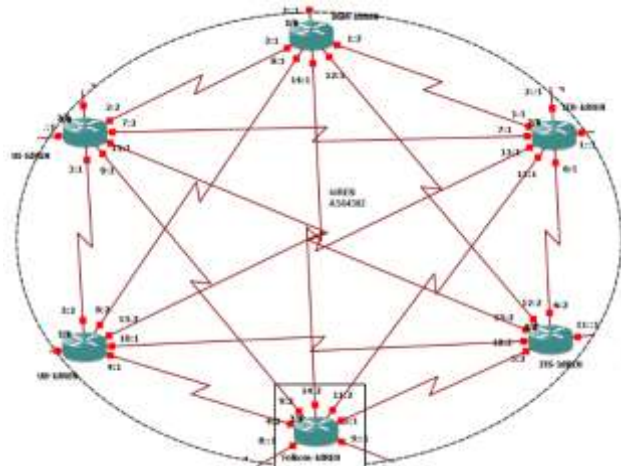

Figure 3. The Last iBGP IdREN Topology (Full Mesh)[8]

Design of Full Mesh Routing used in iBGP topology has lacks when it is used in a big scale where the configuration been complex and it makes difficulty for administrator to setting it on every changing made [9].

Beside Full Mesh, the other method to reduce this iBGP routing complexity are Route Reflector and BGP Confederation [10], [11].

This research focus on BGP Confederation method as a solution to test it by using some scenarios on knowing the effect of BGP Confederation topology design inside internal BGP.

C. IPv6

IdREN network in migration transition period from Internet Protocol version 4 (IPv4) to IPv6 so on its implementation there are some parts of AS, represents the Institution, still use IPv4 format while the others use IPv6 or dual stack IPv4/IPv6[4].

IdREN advertised the prefix IPv4 103.78.232.0/22 and prefix IPv6 2001:df6:5a00::/48 then shaped into peer as seen in Figure 4 and Figure 5 [4].

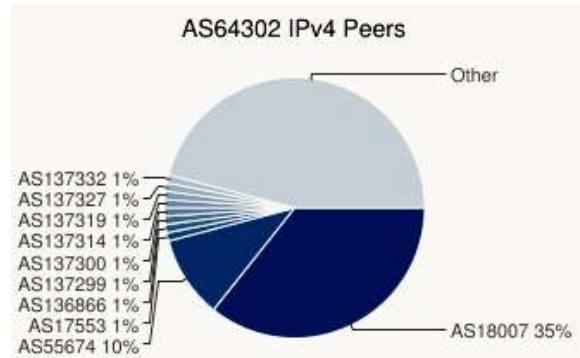

Figure 4. IPv4 Peers Composition of IdREN[4]

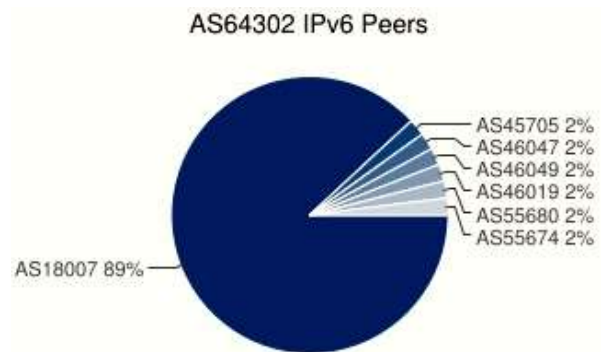

Figure 5. IPv6 Peers Composition of IdREN [4].

As part of global adaptation in the future, Institution/University in IdREN need to adjust to the previous Institution members in preparing migration process to IPv6.

II. RELATED RESEARCH

There is some research related to BGP and IdREN. Previous research which discussed the using of Weight BGP on prior IdREN, the INHERENT [12]. There was also a research about discussed the BGP attribute engineering on IdREN topology [8].

Furthermore, the research on the effect of network model has been done with topic on Open Shortest Path First (OSPF) protocol, tested by Ping application and File Transfer Protocol (FTP) [13]. Besides that, also developed research to answer some questions related to simulation scenario on iBGP Confederation but they used Transmission Control Protocol (TCP) data and MikroTik testing ware in term of IPv4 protocol [14]. The research about effect of the BGP Confederation topology scheme on iBGP IdREN using the GNS3 simulator was done and the results showed that the 2 Sub AS topology scheme was better than other scenarios in the study [1].

Research conducted on African NREN BGP by testing three layer 3 protocols, namely TCP, UDP and ICMP. Testing is done to find out the path through the data package, packet loss is large and delay to get to the destination. From the research, it can be concluded that the data package in the UDP protocol results in



the highest packet loss among other protocols. The highest delay was also obtained on the UDP protocol by measuring the RTT of each protocol. There is no significant influence on the pathway passed in the three types of protocol [15]. Research on the network of Malaysian REN (MYREN) has been also done by testing the implementation of the VoIP emulator test using WANem to assess QoS based on delay, jitter and packet loss. The results show that QoS is not affected by Emulators [16]. Research has been also on GEANT (REN Europe), to try a new routing protocol design, C-BGP. The protocol can be used to calculate the results of BGP route selection when there are many domains. But this protocol is still in the process of improvement, more knowledge is needed on the structure and domain policy so that this protocol functions properly [17].

III. TESTING SCENARIO

On this paper, there are several topologies with BGP Confederation methods on iBGP IdREN.

Testing was conducted by using Graphical Network Simulator 3 (GNS3) on 3 scenarios to test its topology scheme performance. The traffic was applied to tested topology by using Iperf3 run on the VM Ubuntu Operation System.

All of the router whether internal or external BGP are then configured by protocol IPv6 so that the scenario will reflect the next condition of IdREN.

QoS from the-will-be-tested BGP Confederation scenario was measured based on 4 parameters i.e. Delay, jitter and throughput and Lost Datagram. Each of them will produce a compared value between each scenario.

Delay is the total time needed for a packet to travel from the origin (sender) to the destination (recipient). Delay from sender to receiver is basically composed of hardware latency, access delay, and transmission delay[18].

Jitter is a variety of package arrivals, this is caused by variations in queue length, in data processing time, and also in the time of reassembling packages at the end of the package trip [18].

Throughput is the rate of effective data transfer, measured in bps. Throughput is related to the available bandwidth on the network. Bandwidth provided is not all used by applications on the network. The amount of bandwidth used by the application is throughput [18].

Lost datagram is packet transmission failure reaches its destination or the number of packets lost. This can be caused by a number of possibilities, namely traffic overload, network congestion, physical media errors, and buffer. In network implementation, the value of packet loss is expected to have a minimum value [18]. In this study packet loss uses lost datagram in accordance with the term used on the Iperf3 Traffic Generator.

Four tested scenarios were made according to real IdREN which had 6 Border Gateway iBGP. Scenario simulation was made by using Router Cisco c3640 to omit all of BGP attributes

(optional) to gain the result matching with research aim in finding the best topology scheme.

A. Case Scenario of 2 Sub AS

On this scenario, iBGP of IdREN was divided into 2 Sub AS by each consisted of 3 node routers.

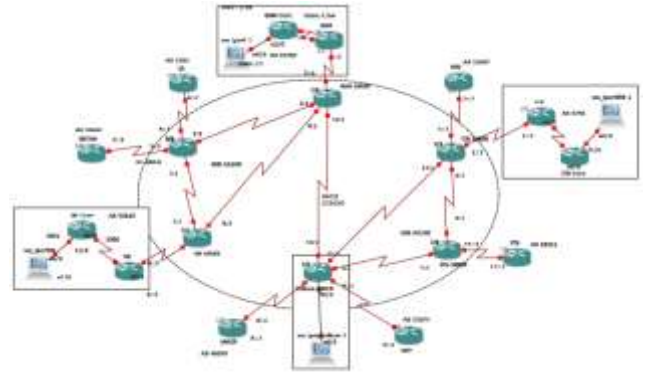

Figure 6. iBGP Topology with 2 Sub AS

Figure 6 showed iBGP of IdREN with AS64302 was divided into 2 Sub AS, Sub AS100 and Sub AS200. By 6 IdREN Border Router, the Combination was then obtained,

$$C(6,3) = \frac{6!}{(6-3)! \cdot 3!} = 20. \quad (1)$$

but this paper only tested one combination (showed at Figure 4) as test representative by 2 Sub AS.

B. Case Scenario of 3 Sub AS

On this scenario, iBGP IdREN was divided into 3 Sub AS such as AS100, AS200 and AS300. Each of them consisted of 2 node router. Same like Scenario 2 Sub AS, this scenario produced some combinations.

$$C(6,2) = \frac{6!}{(6-2)! \cdot 2!} = 15 \quad (2)$$

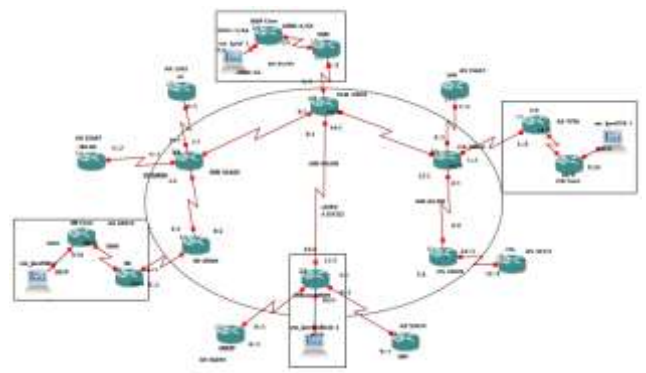

Figure 7. iBGP Topology with 3 Sub AS

C. Case Scenario of 6 Sub AS

On this scenario, iBGP of IdREN was divided into 6 Sub AS. Each of them had 1 node router. It looked like ring topology if we see it at glance.



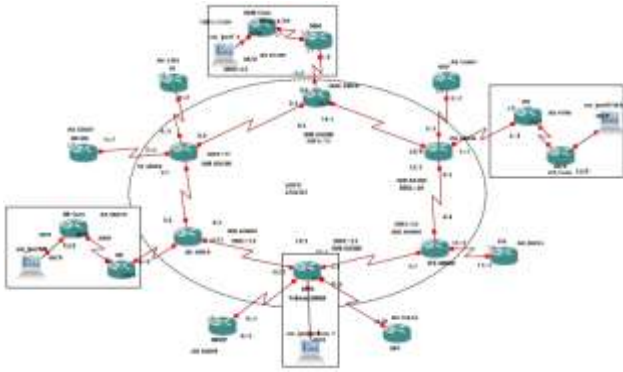

Figure 8. iBGP Topology with 6 Sub AS

After finishing the mentioned network configurations, some further tests were conducted to obtain the best QoS between scenarios. Those used load giver application, iperf3, which would produce artificial traffic from Client to Server based on input parameter.

There were some parameters used on the tests, Testing Data Size: 100 Mbytes and 2 Mbytes; Bandwidth Set = 100 Mbps and 2 Mbps, Kind of Data: UDP, and Testing Route: UB (Client) - ITB (Server).

After testing, some data were then taken listed below: Throughput, Jitter, Delay and Lost Datagram

All of those three scenarios took two routers outside the iBGP which had function as Client and Server during the testing process. The connection of Client and Server then shaped topology of BGP External into iBGP of IdREN. The furthest route from its hop between Client and Server was chosen to maximize test result.

IV. RESULT AND DISCUSSION

A. Results of Scenario Simulation with Bandwidth Set 100 Mbps

1) Delay

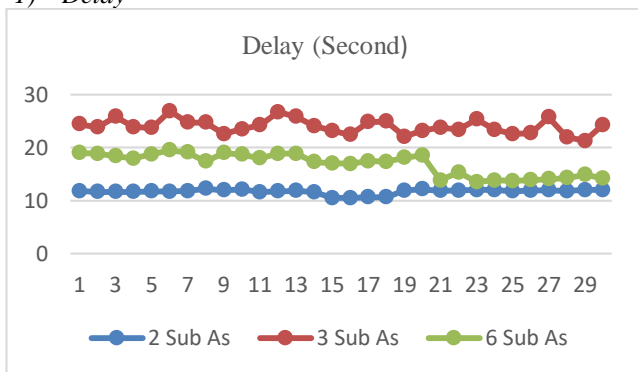

Figure 9. Graphic of Delay Comparison of Every Sub AS

The results of the normality test with Shapiro Wilk test showed the p value of the data of group 2 Sub AS and 6 Sub AS <0.05 so that it was transformed with log10 but the results remained abnormal. The Kruskal-Wallis test results showed a

value of $p < 0.05$ so that it was continued with post hoc using Mann Whitney (Table 1). In delay testing in scenario 2 of Sub AS, group 3 Sub AS and group 6 Sub AS obtained significant differences. The Mann-Whitney test concluded that there were differences between all groups. The mean delay rating of the 2 Sub AS group was lower than the other groups.

TABLE I. RESULTS OF DELAY ANALYSIS WITH KRUSKAL-WALLIS

	Groups	n	Mean Rank	p
Delay	2 Sub AS	30	15,50	<0,001
	3 Sub AS	30	75,50	
	6 Sub AS	30	45,50	

Post Hoc Mann-Whitney: 2 Sub AS vs 3 Sub AS $p < 0,001$; 2 Sub AS vs 6 Sub AS $p < 0,001$; 3 Sub AS vs 6 Sub AS $p < 0,001$

2) Throughput

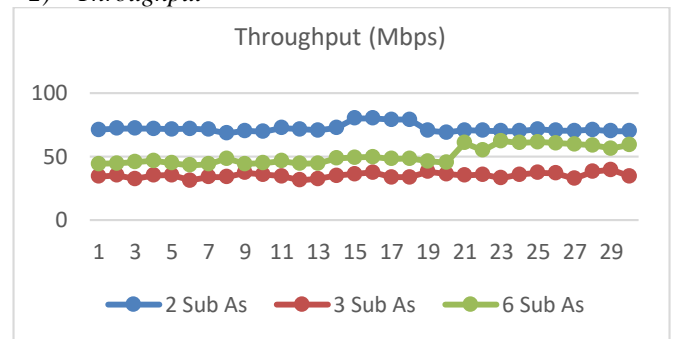

Figure 10. Graphic of Throughput Comparison of Every Sub AS

The results of the normality test using the p value of the 2 Sub AS and 6 Sub AS groups <0.05 so that the transformation is done with log10 but the transformation results remain abnormal. The Kruskal-Wallis test results showed p value <0.05 so that it was continued with the Mann Whitney post hoc (Table 2). In the throughput test in the 2 Sub AS scenario, 3 Sub AS and 6 Sub AS groups differed. The Mann-Whitney test concluded that there were differences in each scenario. The mean throughput ranking in the 2 Sub AS group was lower than the other groups.

TABLE II. RESULTS OF THROUGHPUT ANALYSIS WITH KRUSKAL-WALLIS

	Groups	n	Mean Rank	p
Throughput	2 Sub AS	30	75.50	<0,001
	3 Sub AS	30	15.50	
	6 Sub AS	30	45.50	

Post Hoc Mann-Whitney: 2 Sub AS vs 3 Sub AS $p < 0,001$;
 2 Sub AS vs 6 Sub AS $p < 0,001$; 3 Sub AS vs 6 Sub AS $p < 0,001$

3) Jitter

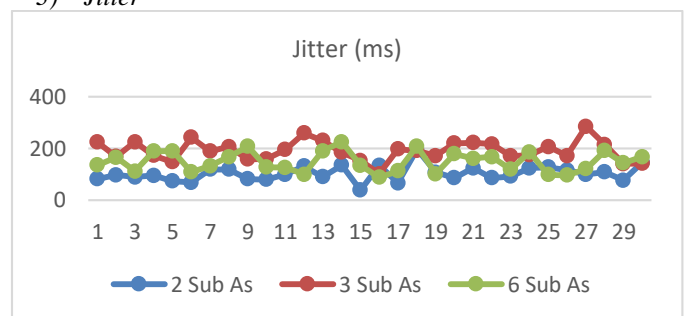

Figure 11. Graphic of Jitter Comparison of Every Sub AS

The results of the normality test using the Shapiro Wilk test show all p values > 0.05, meaning that data is normally distributed. The homogeneous test results of Lavene's Test obtained a value of p > 0.05, which means that the data variant is homogeneous. Hypothesis testing with one-way ANOVA shows p value <0.05, meaning that there are differences between groups so that it is continued with Bonferroni's Multiple Post Comparison (Table 3). In the Bonferroni Multiple Comparison test it was concluded that there were differences in each scenario. The mean (s.d) of jitter in the 2 Sub AS group was lower than the other groups.

TABLE III. RESULTS OF JITTER ANALYSIS WITH ONE WAY ANOVA

	Groups	n	Means (s.d) ms	P
Jitter	2 Sub AS	30	102,53 (3.02)	<0,001
	3 Sub AS	30	191,07(3.91)	
	6 Sub AS	30	147,95(3.92)	

Post Hoc of Bonferroni: 2 Sub AS vs 3 Sub AS p<0,001;
 2 Sub AS vs 6 Sub AS p < 0,001; 3 Sub AS vs 6 Sub AS p < 0,001

4) Lost Datagram

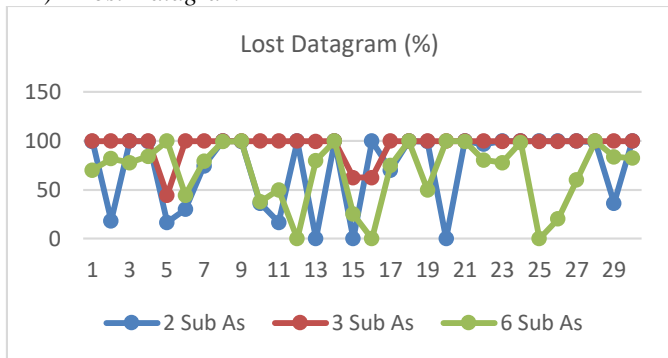

Figure 12. Graphic of Lost Datagram Comparison of Every Sub AS

The normality test using the Shapiro Wilk test shows the p value of the group data for all scenarios <0.05 so that it is transformed with log10 but the transformation results are still not normal. The results of the Kruskal-Wallis hypothesis test showed p values <0.05 so that it was continued with the Mann Whitney post hoc (Table 4). In testing lost datagram in scenario 2 of Sub AS, group 3 Sub AS and group 6 Sub AS were different. The Mann-Whitney test concluded that there were differences in each scenario. The mean lost datagram in the Sub AS 2 group was lower than the 3 Sub AS group and higher than the 6 Sub AS group.

TABLE IV. RESULTS OF LOST DATAGRAM ANALYSIS WITH KRUSKAL-WALLIS

	Groups	n	Mean Rank	P
Lost datagram	2 Sub AS	30	38.87	<0,001
	3 Sub AS	30	65.35	
	6 Sub AS	30	32.28	

Post Hoc of Mann-Whitney: 2 Sub AS vs 3 Sub AS p<0,001; 2 Sub AS vs 6 Sub AS p=0,249; 3 Sub AS vs 6 Sub AS p<0,001.

B. Results of Scenario Simulation with Bandwidth Set 2 Mbps

1) Delay

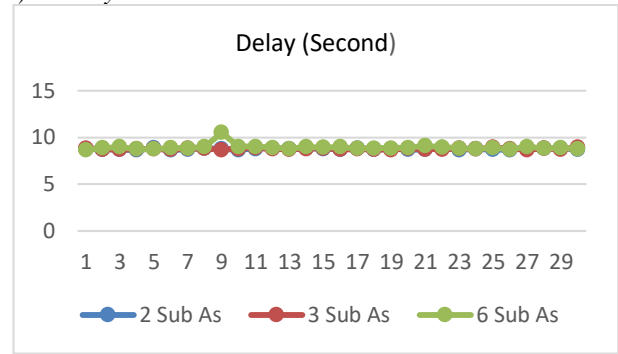

Figure 13. Graphic of Delay Comparison of Every Sub AS

The normality test with Shapiro Wilk shows the p value of the 6 Sub AS group < 0.05, which is 0.001 so that it is transformed with log10 but the results are still not normal. The Kruskal-Wallis test showed p value < 0.05 so that it was continued with the Mann Whitney post hoc (Table 5). The results of the delay testing of the 2 Sub AS group, 3 Sub AS group and 6 Sub AS group had significant differences. Result of Mann-Whitney test a decision was made that there was a difference between the 2 Sub A scenarios with 6 Sub AS and 3 Sub AS scenarios with 6 Sub AS but not different between scenario 2 Sub AS with 3 Sub AS. The mean delay ranking in the 2 Sub AS group was lower than the other groups.

TABLE V. RESULTS OF DELAY ANALYSIS WITH KRUSKAL-WALLIS

	Groups	n	Mean Rank	p
Delay	2 Sub AS	30	33.88	<0,001
	3 Sub AS	30	37.97	
	6 Sub AS	30	64.65	

Post Hoc with Mann-Whitney: 2 Sub AS vs 3 Sub AS p=0,472 Sub AS vs 6 Sub AS p<0,001; 3 Sub AS vs 6 Sub AS p<0,001

2) Throughput

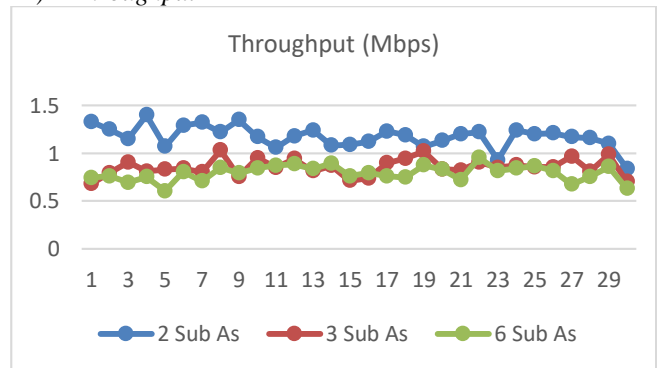

Figure 14. Graphic of Throughput Comparison of Every Sub AS

The results of the normality test with the Shapiro Wilk test show all p values > 0.05 means that the data is normally distributed. Homogeneous test results with Lavene's Test obtained a value of p> 0.05, which means that the data variant is homogeneous. The results of the one-way ANOVA test show a



p value of <0.05, meaning that there are differences between groups so that it is continued with Bonferroni's Multiple Post Comparison (Table 6). In the Bonferroni Multiple Comparison test it was concluded that there were differences in each scenario. The mean (s.d) throughput on 2 Sub AS group was lower than other groups.

TABLE VI. TABLE 6 RESULTS OF THROUGHPUT ANALYSIS WITH ONE WAY ANOVA

	Groups	n	Means (s.d) Mbps	p
Throughput	2 Sub AS	30	1,17(0,11)	<0,001
	3 Sub AS	30	0,85(0,08)	
	6 Sub AS	30	0,79(0,08)	

Post Hoc Bonferroni: 2 Sub AS vs 3 Sub AS p<0,05;
 2 Sub AS vs 6 Sub AS p<0,05; 3 Sub AS vs 6 Sub AS p<0,05

3) Jitter

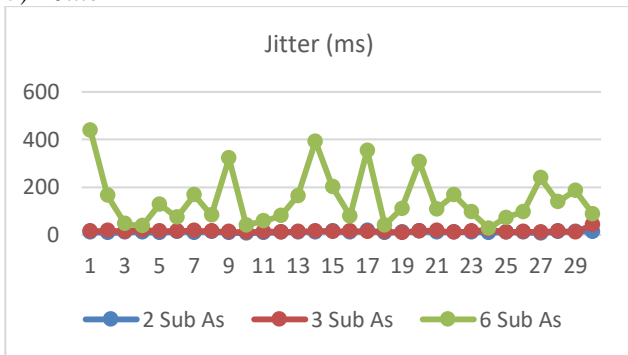

Figure 15. Graphic of Jitter Comparison of Every Sub AS

The normality test of Shapiro Wilk shows the p value of data in 3 Sub AS and 6 Sub AS groups <0.05 so that it is transformed with log10. The transformed data shows that 3 Sub AS group is still not normal. The Kruskal-Wallis test results showed p value <0.05 so that it was continued with the Mann Whitney post hoc (Table 7). In testing jitter in scenario 2 Sub AS, 3 Sub AS and 6 Sub AS were significant differences. The Mann-Whitney test concluded that there were differences in each scenario. The mean ranking of jitter in 2 Sub AS was lower than the other groups.

TABLE VII. RESULTS OF JITTER ANALYSIS WITH KRUSKAL-WALLIS

	Groups	n	Mean Rank	p
Jitter	2 Sub AS	30	21.23	<0,001
	3 Sub AS	30	39.90	
	6 Sub AS	30	75.37	

Post Hoc Mann-Whitney: 2 Sub AS vs 3 Sub AS p<0,001;
 2 Sub AS vs 6 Sub AS p<0,001; 3 Sub AS vs 6 Sub AS p<0,001

4) Lost Datagram

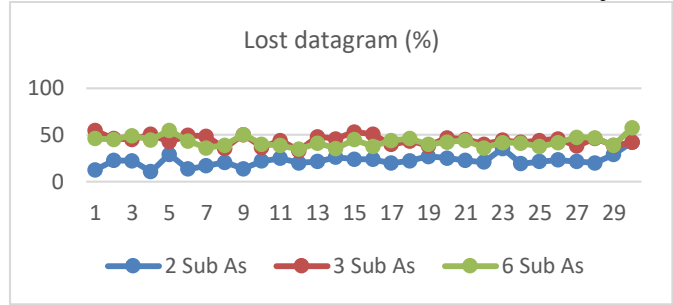

Figure 16. Graphic of Lost Datagram Comparison of Every Sub AS

The results of the Shapiro Wilk normality test show the p value of 2 Sub AS data <0.05 so that it is transformed with log10. The transformed data shows that 2 Sub AS group is normal (p > 0.05). Homogeneous testing with Lavene's Test obtained p value > 0.05, which means that the data variant is homogeneous. The results of the one-way ANOVA test show p value <0.05, meaning that there are differences between groups so that it is continued with Bonferroni's Multiple Post Comparison (Table 8). In the Bonferroni Multiple Comparison test it was concluded that there were differences between 2 Sub AS group with 3 Sub AS group, 2 Sub AS group with 6 Sub AS group but no differences between 3 Sub AS with 6 Sub AS group. The geometric mean (CI) in 2 Sub AS group is lower than the other groups.

TABLE VIII. RESULTS OF THROUGHPUT ANALYSIS WITH ONE WAY ANOVA

	Groups	n	Geometric Mean (CI) %	P
Lost datagram	2 Sub AS	30	21,58 (19,59-24,17)	<0,001
	3 Sub AS	30	43,65 (42,1-46,07)	
	6 Sub AS	30	41,69 (40,64-44,61)	

Post Hoc Bonferroni: 2 Sub AS vs 3 Sub AS p<0,001;
 2 Sub AS vs 6 Sub AS p<0,001; 3 Sub AS vs 6 Sub AS p = 0,992

V. CONCLUSIONS

Conclusions based on the study are as follows: 1. Topology scenario 2 Sub AS produces better performance than scenario 3 Sub AS and scenario 6 Sub AS is viewed from delay, throughput and jitter in BGP Confederation simulation with 6 routers in iBGP IdREN; 2. Scenario 2 Sub AS is recommended for use in the iBGP topology with the BGP Confederation method for UDP data types; 3. Delay, throughput and jitter are not linear with the addition of the number of Sub AS in both high bandwidth (100 Mbps) and low bandwidth (2 Mbps); 4. In high bandwidth (100 Mbps) the results of scenario 6 Sub AS obtained are better than 3 Sub AS, while in low bandwidth (2 Mbps) the results of scenario 3 Sub AS are better than 6 Sub AS; 5. The lost datagram cannot be concluded for high bandwidth testing (above 2 Mbps) due to a bug or defect in the Iperf3 traffic generator application, at low bandwidth (2 Mbps) the lowest lost datagram conclusion is obtained in scenario 2 Sub AS.



REFERENCES

- [1] I. W. Lahusen and S. S. Kusumawardani, "Topology Analysis of BGP Confederation of iBGP Indonesia Research and Education Network (IdREN)," pp. 2–6.
- [2] A. Basuki and A. Basalamah, "Indonesia Research & Education Network (IDREN) - Past, Present & Future," 2017.
- [3] "IdREN Website." .
- [4] "AS64302 IdREN, Hurricane Electric Internet Service," 2018. .
- [5] B. Suhardiman, "Inherent / IDRen status update in Indonesia by August 2018," no. August, 2018.
- [6] A. Basuki, "IdREN - Background / Objective, Approach, Milestone," pp. 1–20, 2016.
- [7] B. Suhardiman, "TEIN Activities and in Indonesia," 2015.
- [8] F. Ardian, "Simulasi Routing Policy Pada Border Gateway Protocol Dalam Jaringan IdREN Mempergunakan GNS3," Universitas Gadjah Mada, 2017.
- [9] M.-O. Buob, A. Lambert, and S. Uhlig, "iBGP2: A scalable iBGP redistribution mechanism leading to optimal routing," in *IEEE INFOCOM 2016 - The 35th Annual IEEE International Conference on Computer Communications*, 2016, vol. 2016-July, pp. 1–9.
- [10] Y. Breitbart, M. Garofalakis, A. Gupta, A. Kumar, and R. Rastogi, "On Configuring BGP Route Reflectors," in *2007 2nd International Conference on Communication Systems Software and Middleware*, 2007, pp. 1–12.
- [11] R. Zhang and C. No, *BGP Design and Implementation*. Cisco Press, 2003.
- [12] M. R. Hafiz, "Simulasi Border Gateway Protocol (BGP) pada IPv6 Dalam Proses Pemilihan Jalur Routing," p. 298231, 2015.
- [13] L. S. Moonlight and S. Suhardi, "Pengaruh Model Jaringan Terhadap Optimasi Routing Open Shortest Path First (OSPF)," *Tekno. J. Ilm. Sist. Inf.*, vol. 1, no. 2, pp. 68–80, 2012.
- [14] N. S. Nugraha, "Analisa Pengaruh Model Jaringan Terhadap Optimasi Dynamic Routing Border Gateway Protocol," 2013.
- [15] R. Sanby, "Topology Discovery for African NRENS," in *Computer Science Honours Final Paper 2015*, 2015.
- [16] H. Z. Abidin, M. I. Ramlan, and A. I. M. Yasin, "Implementation of VoIP over Malaysian Research and Education Network (MYREN) Emulator Testbed," *IEEE Symp. Comput. Informatics*, 2011.
- [17] Bruno Quoitin and Steve Uhlig, "Modeling the Routing of an Autonomous System with C-BGP," 2005.
- [18] Croll, Alistair, and E. Packman, *Managing Bandwidth : Deploying QoS in Enterprise Networks*, 1st ed. USA: Prentice Hall PTR Inc., 1999.

